



CHEVY/GMC "S"-SERIES PICKUP (S10, S15, SONOMA)

BODY LIFT

INSTALLATION INSTRUCTIONS

1994-97 2" KIT # 102

*1994 3" KIT # 103

*For detailed application information, see the **WARNING** at the top of the next page.

⚠ WARNING
Installation of a Performance Automotive Group body lift kit will change the vehicle's center of gravity and handling characteristics both on- and off-road. You must drive the vehicle safely! Extreme care must be taken to prevent vehicle rollover or loss of control, which could result in serious injury or death. Avoid sudden sharp turns or abrupt maneuvers and always make sure all vehicle occupants have their seat belts fastened.

⚠ WARNING
Before you install this kit, read and understand all instructions, warnings, cautions, and notes in this instruction sheet and in the vehicle owner's manual.

⚠ CAUTION
Proper installation of this kit requires knowledge of the factory recommended procedures for removal and installation of original equipment components. We recommend that the factory shop manual and any special tools needed to service your vehicle be on hand during the installation. Installation of this kit without proper knowledge of the factory recommended procedures may affect the performance of these components and the safety of the vehicle. We strongly recommend that a certified mechanic familiar with the installation of similar components install this kit.

⚠ WARNING
This kit should only be installed on a vehicle that is in good working condition. Before you install the kit, thoroughly inspect the vehicle for corrosion or deformation of the sheet metal around the factory body mounts. If the vehicle is suspected to have been in a collision or misused, do not install this kit. Off-road use of your vehicle with this kit installed may increase the stress applied to the factory body mounts. We do not recommend that any vehicle with a body lift kit installed be involved in any extreme off-road maneuvers such as jumping. Failure to observe this warning may result in serious personal injury and/or severe damage to your vehicle.

⚠ WARNING
Many states and municipalities have laws restricting bumper heights and vehicle lifts. Consult state and local laws to determine if the changes you intend to make to the vehicle comply with the law. Before combining a body lift with a suspension lift, consult an installation professional to see how this will affect the vehicle.

⚠ WARNING
The installation of larger tires may reduce the effectiveness of the Braking System.

⚠ WARNING
Always wear eye protection when operating power tools.

⚠ WARNING
Before you install this kit, block the vehicle tires to prevent the vehicle from rolling.

⚠ WARNING
Accidental deployment of the air bag can result in serious personal injury or death. To avoid accidental deployment during installation of the kit, the Supplemental Restraint System (SRS, or airbag) must remain deactivated. Do not allow anyone near the airbag during installation. Refer to the factory service manual or owner's manual for the recommended procedure to disable the SRS. After you install the kit, reactivate the SRS before driving the vehicle.

⚠ NOTE
Performance Automotive Group recommends using the Loctite® supplied in the kit on the threads of all kit nuts and bolts unless specified otherwise in these instructions.

Before Starting Installation

⚠ WARNING

DO NOT install Kit 103 on vehicles with a slip-joint in the steering shaft. Vehicles covered in this document are equipped with one of two different types of steering shafts: one *without* a slip-joint and one *with* a slip-joint:

Vehicles WITHOUT a slip-joint: On these vehicles, two pieces of the steering shaft are bolted together in the engine compartment near the firewall. This type of steering shaft must be extended using the kit **extension** (steering) and the steering column must be relocated as specified later in this document. Kit 103 can safely be installed on vehicles without a slip-joint.

Vehicles WITH a slip-joint: On these vehicles, one piece of the shaft telescopes into the other. The entire shaft is covered with an orange boot. When lifting the cab, the slip joint will compensate for the change in the length of the shaft. **DO NOT** install the kit **extension** (steering) and **DO NOT** relocate the steering column. If the shaft is extended or if the steering column is relocated, the shaft will bind which could result in loss of steering control. **DO NOT install Kit 103 on vehicles with a slip-joint.**

Kit 102 can be installed on vehicles equipped with or without a slip-joint.

⚠ NOTE

Kit parts are prefaced by the word kit and appear in **bold** print.

1. Carefully read all warnings and instructions completely before beginning.
2. Verify all parts have been received in this kit by checking the parts list at the end of this document.

⚠ NOTE

If parts are missing from kit, please be prepared to provide the following information:

1. **Name** of purchase location
2. **Bar Code** on side of box
3. **Date** above bar code
4. **Date** inside box cover
5. **Inspector #** from inside box cover

3. **Only install this kit on the vehicle for which it is specified.** If anytime during the installation you encounter something different from what is outlined in the instructions, call technical support at (928) 636-7080.

4. Special tools needed:
 - a. Welder or access to a professional welding shop (required only if installing **Kit 103** on a vehicle with **automatic transmission**).
5. Park the vehicle on a clean, dry, flat, level surface and block the tires so the vehicle cannot roll in either direction.
6. **Measure (front bumper):** Measure and record distance between front bumper and fenders.
Driver Side ____ Passenger Side ____
7. **Measure (cab-to-bed):** Measure and record distance between cab and bed.
Driver Side ____ Passenger Side ____
8. **Measure (rear bumper):** Measure and record distance between rear bumper and bed.
Driver Side ____ Passenger Side ____
9. **Battery cables:** Disconnect both battery cables. Disconnect negative cable first, then positive cable.
10. **Airbag fuse:** Remove airbag fuse, if equipped. (Check owner's manual for fuse location.)

Prepare to Install Kit

1. **4WD only (battery tray):** Remove battery hold-down. Remove battery. Remove two bolts holding battery tray to core support. Remove battery tray. Remove two bolts holding vacuum canister to inner fender below battery tray.
2. **4-cylinder only (intake air duct):** Remove two clamps connecting two flexible hoses to plastic intake air duct on top of radiator. Remove plastic intake air duct from top of radiator by gently pulling it straight up.
3. **Wiring harness and hoses at frame:** Remove wiring harness and vacuum hoses from clips on both sides of frame.

4. **Grille:** Remove six screws, four spring clips, and grille from body, being careful to prevent damage to spring clips.
5. **Front bumper:** Remove two outside bumper support mounting bolts from bumper. Remove four inside bumper-to-frame bolts. Slide bumper out and of two guide pins that are built into body.
6. **Rear bumper:** Remove two license plate lights from rear bumper. Remove six bolts holding bumper brackets to frame. Remove bumper.
7. **Spare tire:** Remove cotter pin from spare tire crank tube and cranking mechanism. Remove spare tire crank tube.
8. **Fuel filler:** Remove three screws holding fuel filler neck to body.

14. **4WD only (shift cable):** Loosen clip holding transfer case shift cable to body.
15. **Manual transmission shift console:** Remove shift knob from shift lever. Remove screws holding shift boot to console. Remove boot. Remove screws holding console to floor. Remove console from vehicle.

⚠ WARNING

Accidental deployment of the air bag can result in serious personal injury or death. To avoid accidental deployment during installation of the lift kit, the Supplemental Restraint System (SRS, or airbag) must remain deactivated. Do not allow anyone near the airbag during installation. Refer to the factory service manual or owner's manual for the recommended procedure to disable the SRS. After kit installation, the SRS must be reactivated before driving the vehicle.

⚠ CAUTION

If the steering wheel is not strapped to prevent accidental movement, the airbag clockspring could be damaged. DO NOT turn the steering wheel while the steering shaft is disconnected.

⚠ NOTE

Kit 102: On vehicles WITHOUT a slip-joint in the steering shaft, it might not be necessary to relocate and reinstall the steering column as specified in the following steps.

- ⚠ WARNING**
If the engine cooling system is hot, the coolant will be HOT and UNDER PRESSURE. To prevent serious personal injury, wait until the cooling system is completely cool before removing the cap from the radiator.
9. **V6 only (fan shroud):** Drain radiator into a clean container. Remove four bolts holding upper fan shroud to lower fan shroud. Remove five bolts holding upper fan shroud to core support. Remove lower fan shroud from three clips at bottom of radiator by gently prying tab away from radiator and pulling up on fan shroud. Allow lower fan shroud to lay under fan.
 10. **V6 only (oil filter adapter):** Remove two bolts holding oil filter adapter to core support.
 11. **V6 only (heater hose):** Remove heater hose from heater core and intake manifold.
 12. **V6 only (vacuum brake booster hose):** Remove hose from vacuum brake booster and intake manifold.
 13. **Automatic transmission shift linkage:** Loosen bolt holding shift rod to transmission linkage near transmission. Remove spring clip attaching shift rod to steering column shift lever. Remove shift rod.

16. **Steering column (relocation):** Set front wheels straight ahead. Strap steering wheel to prevent accidental movement. In engine compartment, mark the axis of the upper and lower steering shafts where they are bolted together.
17. Remove bolt holding upper and lower steering shafts together. Slide lower steering shaft down and off of upper steering shaft.
18. Remove three bolts holding steering column to firewall. Inside the vehicle, remove lower dash panel that runs from the driver side of vehicle all the way across to center, almost to passenger side. Loosen, but DO NOT remove, two nuts holding steering column to dash assembly. Slide steering column up slightly to allow for movement at firewall. At firewall, slide column about 3/4" down and slightly to the left to prevent steering shaft from contacting exhaust manifold. Be sure holes in steering column flange fully engage with sheet metal at firewall.

19. Inside the cab, mark new mounting locations for drilling. On automatic transmission, mark location where shift indicator wire is attached to bottom of steering column by a clip. Slide clip off bottom of steering column. Disconnect all seven wire connectors from steering column. Remove two steering column mounting nuts, and carefully remove steering column from vehicle.

20. Drill a 5/16" hole where marks were made earlier. Using a breaker bar and a socket, carefully break off three nuts that are tack-welded to steering column flange.

21. **Steering column (installation):** Insert steering column through firewall. Align holes in steering column flange with new holes in firewall. Install steering column on dash assembly with two stock nuts, but DO NOT tighten at this time. Connect wiring harnesses to steering column. Install steering column on firewall with three kit **bolts** (5/16" x 1"), six kit **washers** (5/16" SAE), and three kit **nuts** (5/16" nylock). DO NOT tighten at this time. Adjust steering column as necessary. Tighten fasteners at firewall and dash assembly. Connect shift indicator wire to its original position on steering column. Install lower dash panel.

Install Kit

1. **Cab:** Loosen, but DO NOT remove, cab mounting bolts on driver side.

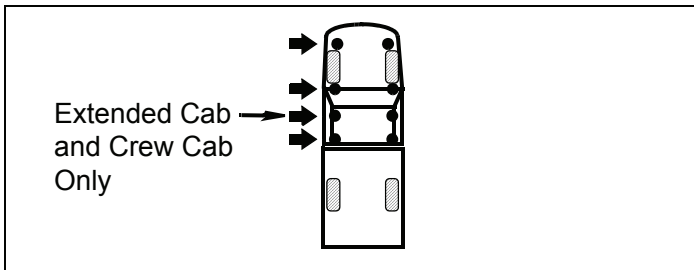

2. Remove cab mounting bolts from passenger side only. The large factory washer at the core support will be reused. Cut off bolt head and remove washer. Drill out washer to 1/2".

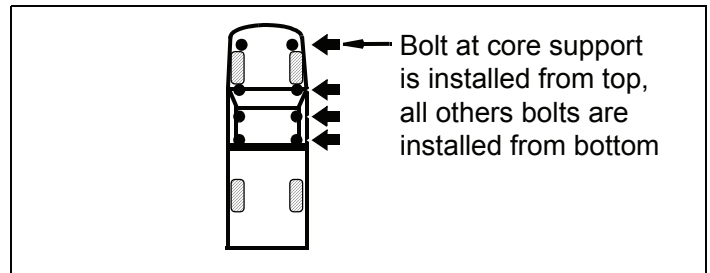

⚠ WARNING

Use extreme caution when lifting the body from the frame. To prevent serious personal injury, ensure the lifting device is securely placed. Keep your hands out from between the body and frame.

⚠ CAUTION

To prevent damage to the vehicle when lifting the body, continually check hoses, wires, lines, etc. to be sure that everything is flexing properly and not binding. Be especially careful not to kink the A/C hoses at the firewall. Ensure brake lines stretch while lifting. It may be necessary to bend the lines to gain ample slack. Be extremely careful not to kink the lines.

3. Using a hydraulic jack and a wooden block, slowly raise passenger side of cab just high enough to install a kit **block** on top of each of the factory body mount bushings.

⚠ WARNING

The kit **blocks** must be installed in addition to the factory bushings. Installing the kit **blocks** without the factory bushings could result in damage to the vehicle or serious personal injury.

4. Place kit **block** (3" diameter) on top of bushing at each mount.

5. Lower the cab onto kit **blocks**.

6. For the core support mount, insert a kit 12mm **bolt** (140mm length on Kit 102; 160mm length on Kit 103) through large factory washer removed earlier. Insert kit **bolt** from the top down through mount. Install kit **washer** (7/16" USS) and factory nut on kit **bolt**. DO NOT tighten at this time.

7. For all other mounts, insert a kit 12mm **bolt** through a kit **washer** (7/16" USS). Install kit **bolt** from the bottom up through mount. DO NOT tighten at this time.
8. Repeat previous steps to install kit **blocks** on driver side of cab.
9. Set the position of cab in relation to bed according to measurements recorded earlier.
10. Remove each kit **bolt** one at a time, apply Loctite® to threads, and install kit **bolt** with washers. Tighten kit **bolts** to manufacturer's specification.
11. **Bed:** Loosen, but DO NOT remove, bolt mounting bolts on driver side.

13. Slowly raise passenger side of bed and place a kit **block** (3" diameter) on frame at each mount. DO NOT raise bed any more than necessary. If a rivet at any of the mounts prevents a 3" diameter kit **block** from being installed, install a 2" diameter kit **block**.
14. At each mount, install a kit 10mm **bolt** (80mm on Kit 102; 100mm on Kit 103) and kit **washer** (3/8" USS). DO NOT tighten at this time.
15. Lower the bed onto the kit **blocks**.
16. Repeat previous steps to install kit **blocks** on driver side of bed.
17. Set position of cab in relation to bed according to measurements recorded earlier.
18. Remove each kit **bolt** one at a time, apply Loctite® to threads, install, and tighten to manufacturer's specification.

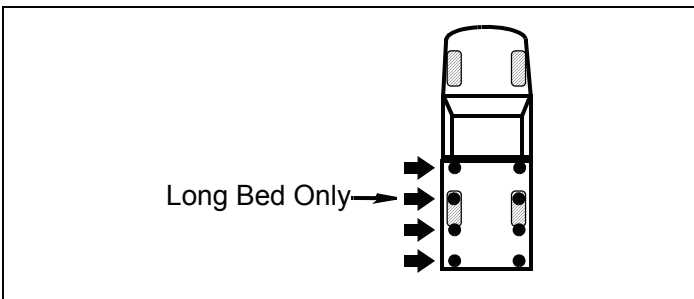

12. Remove bed mounting bolts from passenger side only.

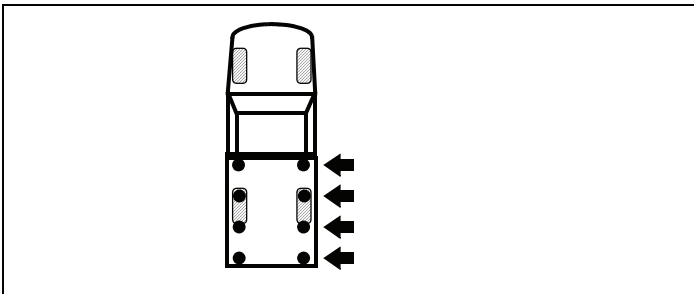

⚠ WARNING
Use extreme caution when lifting the bed from the frame. To prevent serious personal injury, ensure the lifting device is securely placed. Keep your hands out from between the bed and frame.

⚠ CAUTION
To prevent damage to the vehicle while lifting the bed, continually check hoses, wires, brake lines, etc. to ensure everything is flexing properly and not binding. Ensure clearance between bed and cab is maintained.

⚠ WARNING
The following procedure is intended only to enhance the appearance of the vehicle. The rear bumper will no longer be rated for towing of any kind. Towing with the rear bumper after it has been lifted can result in death, serious personal injury, or damage to the vehicle. Towing after the bumper has been lifted should be accomplished using a rated Class III receiver type hitch.

19. **Rear bumper:** Remove stock brackets from bumper. Install kit **brackets** on bumper with stock fasteners. DO NOT tighten. Install bumper on frame with stock fasteners. DO NOT tighten. Adjust bumper using measurements recorded earlier. (Two bolts under the bumper can be used to adjust the bumper from side to side.) Tighten all bumper mounting fasteners to manufacturer's specification.

⚠ WARNING
Use extreme caution when working near the fuel lines and the fuel tank. Clean up spilled fuel immediately. A spark could cause an explosion or fire resulting in serious personal injury and property damage.

20. **Fuel filler hoses:** Disconnect fuel filler vent hose from fuel filler neck (steel tube) and fuel tank. Remove sensor near bottom of filler neck. Disconnect ground strap from frame. Loosen hose clamp securing filler hose to filler neck. Remove filler neck from vehicle. Using a hacksaw, cut filler neck about 2" down from vent hose nipple. Install kit **hose** (2" x 5" hose) between two pieces of fuel filler neck with two kit **hose clamps** (#36). DO NOT tighten kit **hose clamps** at this time. Install filler neck onto hose that is still connected to fuel tank. DO NOT tighten kit **hose clamp** at this time. Install fuel filler neck on body with screws. DO NOT tighten screws at this time. Adjust kit **hose** as necessary. Tighten screws holding fuel filler neck to body. Tighten all hose clamps. Secure sensor to same location on fuel filler neck with kit **zip tie**. Install kit **hose** (5/8" x 18") on vent tube (of filler neck assembly) and fuel tank with two kit **hose clamps** (#10).

21. **Fuel filler ground strap:** Install kit **bracket** (ground strap "S") on frame with stock fasteners. Install fuel filler ground strap on kit **bracket** with kit **bolt** (1/4" x 1"), two kit **washers** (1/4" SAE), and kit **nut** (1/4" nylock).

22. **Spare tire crank tube:** Remove rear license plate. Install spare tire crank tube under crossmember that it was originally over (vehicles with short bed may not be equipped with a crossmember). Secure crank tube to winch with cotter pin. Using a hole saw, cut a 7/8" hole through bumper at the very edge of the recessed area behind license plate. Drill a 5/16" hole 1 1/2" and 2 1/2" from the right edge of the 7/8" hole.

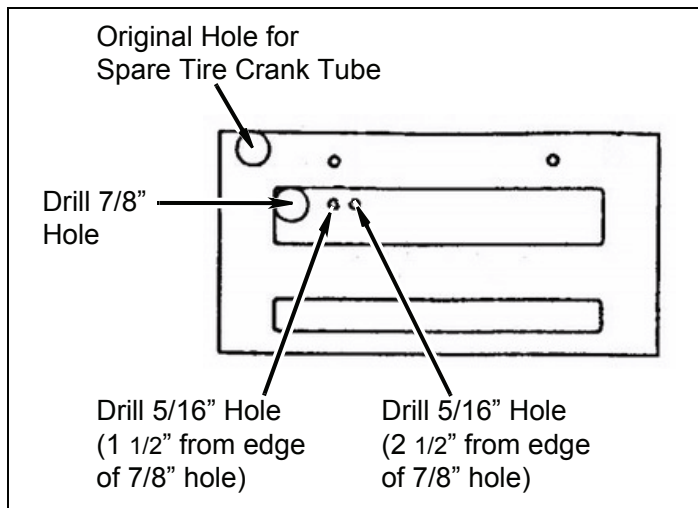

23. Slide kit **bracket** (spare tire crank tube support) over the crank tube.

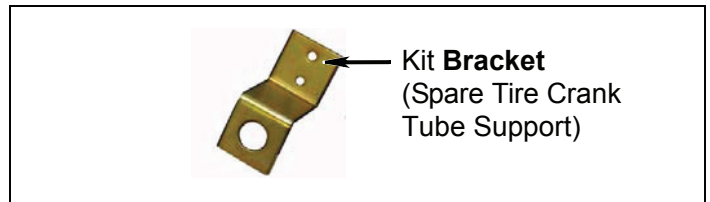

24. While keeping crank tube centered with 7/8" hole in bumper, install kit **bracket** on bumper using two kit **bolts** (1/4" x 1"), four kit **washers** (1/4" SAE), and two kit **nuts** (1/4" nylock). Check operation of spare tire winch. Install license plate.

NOTE
From now on, the license plate will have to be removed to gain access to the spare tire crank tube, so keep a screwdriver in the vehicle at all times.

25. **Fan shroud:** Install upper half of fan shroud with five stock bolts. Install four kit 1/2" OD **spacer tubes** (2" length on Kit 102; 3" length on Kit 103) between upper and lower halves of fan shroud with four kit 3/8" **bolts** (3 1/2" length on Kit 102; 4 1/2" length on Kit 103), eight kit **washers** (3/8" USS), and four kit **nuts** (3/8" nylock). Insert kit **bracket** (lower fan shroud support) into center slot at bottom of fan shroud.

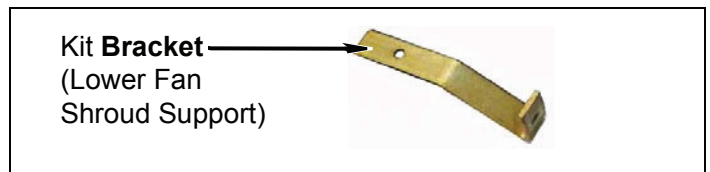

26. Hold kit **bracket** against bottom of core support. Using hole in kit **bracket** as a template, mark bottom of core support.

NOTE
In the following step, if the drill bit is driven too far through the core support, a hole could be drilled in the radiator. When drilling, only drill far enough to drill through the core support.

27. Carefully drill a 1/8" hole in core support where marked. Install kit **bracket** into slot in fan shroud. Install kit **bracket** on bottom of core support with kit **screw**.

28. **4-cylinder only (intake air duct):** Install air duct on top of upper fan shroud. Connect both flexible air

ducts to main air duct. Tighten hose clamps securely.

32. **Ground wire (negative battery cable):** A small (10-gauge) ground wire runs between the battery negative cable and the frame. Remove bolt holding ground wire to frame. Install kit **bracket** (ground strap "S") on frame with bolt that was just removed. Install ground wire on kit **bracket** with one kit **bolt** (1/4" x 1"), two kit **washers** (1/4" SAE), and one kit **nut** (1/4" nylock).

33. **V6 only (brake booster hose):** Install kit **hose** (5/8" x 10") on intake manifold and vacuum brake booster. Install air filter and air intake duct. Tighten mounting bolt at core support securely.

34. **Kit 102 (A/T shift linkage):** Install shift linkage. Adjust as necessary. Tighten adjustment screw securely.

NOTE
V6: The kit contains four brackets (flat, 3" hole-to-hole) for lowering the oil filter adapter. The front brackets (the ones with the large hole at one end) will be installed on the forward face of the core support. The rear brackets (the ones with the holes that are the same size) will be installed on the rear face of the core support (the face closest to the engine).

29. **V6 only (oil filter adapter):** Insert two kit **bolts** (5/16" x 4") through two kit **washers** (5/16" SAE) and 5/16" holes in two kit **brackets** (front).

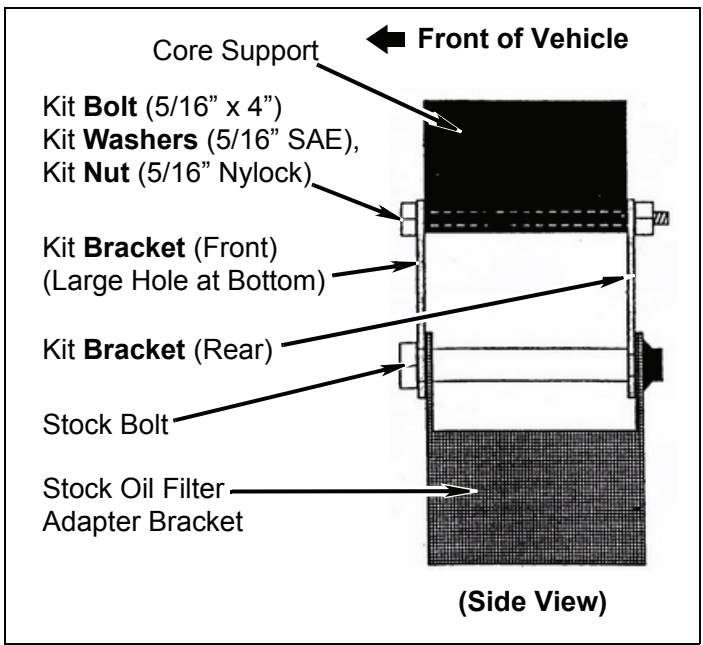

30. Insert kit **bolts** through two original mounting holes in front face of core support. Install kit **brackets** (rear) on kit **bolts** at rear face of core support. Install kit **washers** (5/16" SAE) and kit **nuts** (5/16" nylock) on kit **bolts**. DO NOT tighten at this time. Insert stock bolts through 1/2" holes in kit **brackets** (front), through holes in stock bracket, through 5/16" holes in kit **brackets** (rear), then thread the stock bolts into nuts attached to stock bracket. Be sure stock bracket is mounted straight, then tighten all fasteners securely.

31. **V6 only (heater hose):** Cut through heater hose in a vertical part of the hose. Install kit **extension** between pieces of heater hose with two kit **hose clamps** (#10). Install heater hose. Fill radiator. After installation is complete and the engine has been starting, remember to top off cooling system.

NOTE
 All welding should be done by a certified welder.

35. **Kit 103 (A/T shift linkage rod):** On vertical section of automatic transmission shift linkage rod, scribe a line parallel with axis of rod. Cut lever into two pieces through line. Grind pieces of lever smooth. Ensure scribed lines are aligned and weld kit **extension** (3/8" x 3") between pieces of rod. Grind and paint welds. Install shift rod on steering column lever with washer and spring clip. Install lower end of shift rod on shift linkage. Adjust as necessary. Tighten adjustment bolt securely.

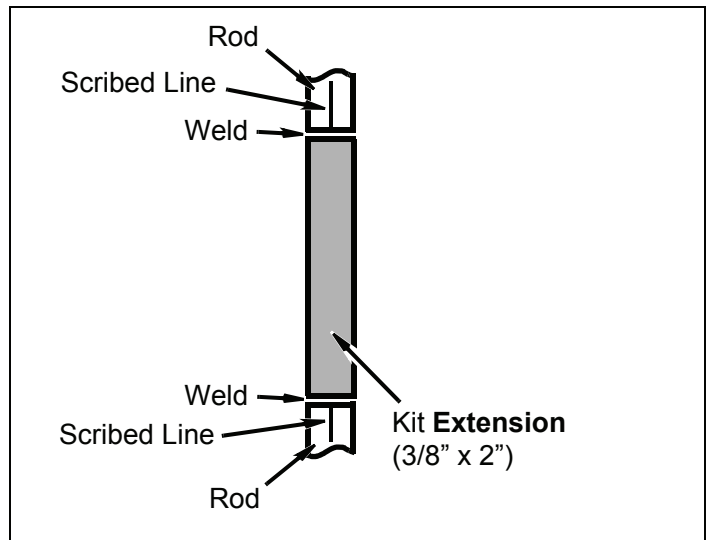

36. **Manual transmission shift lever:** Remove foam pad from between floor and top of transmission. Check operation of shift lever. If shift lever contacts floor, heat and bend shift lever and/or trim floor. (To heat and bend shift lever, remove it from transmission. Heat shift lever between the bottom of shift lever and the first bend. It is usually best to bend it forward and to the right. Install shift lever. Check operation of shift lever. Install shift console, shift boot, and shift knob.

37. **4WD shift cable:** Tighten clip holding transfer case shift cable in place. Be sure there is ample slack in cable.

⚠ WARNING
The following step applies only to vehicles WITHOUT a slip-joint in the steering shaft.

38. **Steering shaft:** Install kit **extension** into lower portion of steering shaft. Align hole in kit **extension** with hole in lower steering shaft. Install kit **bolt** (3/8" x 1 1/2") with kit **washer** (3/8" USS) through steering shaft and kit **extension**. Install kit **washer** (3/8" USS) and kit **nut** (3/8" nylock) on kit **bolt**. DO NOT tighten at this time. Install extended lower steering shaft into upper steering coupler, ensuring marks made earlier are aligned. Install stock bolt through coupler and kit **extension**. Tighten both bolts to manufacturer's specification.

⚠ WARNING
Ensure the kit **extension** is securely installed in the steering shaft. Failure to do so may cause steering malfunction, resulting in loss of steering control.

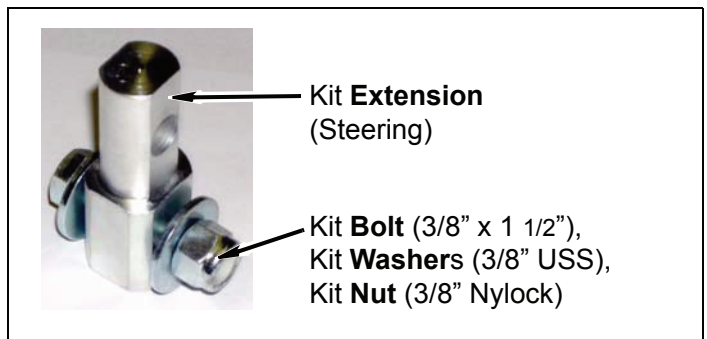

⚠ NOTE
If the bumper valance has air cut-outs, it may be necessary to slightly trim the recessed part of the cut-outs to allow for clearance at the kit **blocks**.

39. **Front bumper:** Place four kit **blocks** (front bumper) on front bumper mounting pads, placing kit **blocks** lengthwise from front to rear.

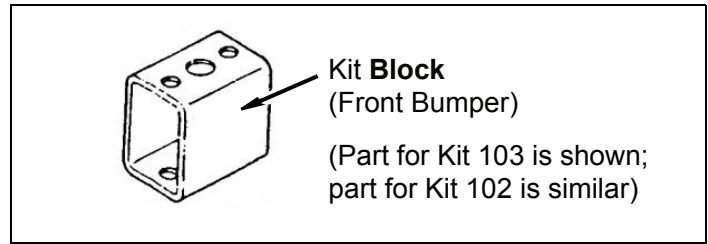

40. Set front bumper on kit **blocks**. At each mount, install a kit 10mm **bolt** (80mm length on Kit 102; 100mm length on Kit 103) with a kit **washer** (3/8" USS) through mounting tab on bumper, then through kit **block**, and then thread it into the stock mounting nut. DO NOT tighten at this time. Loosen bolts holding bumper outer supports to frame. Adjust supports and install in the original mounting location with stock hardware. DO NOT tighten at this time. Adjust clearance between bumper and fenders using measurements recorded earlier. Tighten all bumper mounting hardware securely.

41. **4WD only (vacuum canister):** Relocate vacuum canister, under battery tray, down and to the left. Mark new location of two mounting holes. Drill 5/16" holes in inner fender. Install vacuum canister on inner fender with stock bolts. Install battery tray in its original location with stock hardware. Install battery and battery hold-down.

42. **Grille:** Insert spring clips into original holes in core support, being very careful not to damage clips. Set grille in place. Install mounting screws.

43. **Airbag fuse:** Install airbag fuse.

44. **Battery cables:** Connect both battery cables. Be sure to connect the positive cable first, then the negative cable.

After Completing Installation

1. Apply kit **label** (warning) to dashboard in plain sight of all vehicle occupants.
2. Check all fasteners to ensure they are tight, especially the bolts in the steering shaft.
3. Ensure all wires, hoses, cables, etc. are properly connected and there is ample slack.

⚠ WARNING

If the engine cooling system is hot, the coolant will be **HOT** and **UNDER PRESSURE**. To prevent serious personal injury, wait until the cooling system is completely cool before removing the cap from the radiator.

4. If cooling system was opened, start engine and top off cooling system. Purge air from cooling system according to manufacturer's instructions. Install radiator cap.

Dynamic Vehicle Check

1. Test-drive vehicle. Check steering in both directions to ensure that there is no bind. Check operation of clutch, brake system, and parking brake. Check operation of transmission and transfer case. Ensure there is full engagement in all gears and 4WD ranges. Check the operation of all electrical components.

⚠ WARNING

To prevent worn, damaged, or loose parts from suddenly failing and causing loss of vehicle control, perform the following steps every six months (or 500 miles, whichever comes first) and after **EACH** offroad use:

- Inspect for worn or damaged kit and factory parts in the suspension, braking, and steering systems
- Retorque all nuts and bolts according to the specifications in this document or in the factory service manual.

⚠ CAUTION

Performance Automotive Group does not recommend any particular wheel and tire combinations for use with its body lifts and cannot assume responsibility for the customer's choice of wheels and tires. Refer to your owner's manual for recommended tire sizes and warnings related to the use of oversized tires. Larger wheel and tire combinations increase stress and wear on steering and suspension components, which leads to increased maintenance and higher risk for component failure. Larger wheel and tire combinations also alter speedometer calibration, braking effectiveness, center of gravity, and handling characteristics. Consult an experienced local off road shop to determine which wheel and tire combinations work best with the vehicle.

⚠ WARNING

All warranty information, instruction sheets, and other documents regarding the installation of this product must be retained by the vehicle owner. Information contained in the instructions and on the warranty card will be required for any warranty claims. The vehicle owner needs to understand the modifications made to the vehicle and how they affect handling and performance. Failure to provide the customer with this information can result in damage to the vehicle or severe personal injury.

Kit Parts List

Qty. Description

Kit 102

- 12 **Block**, 2" height x 3" diameter
- 4 **Block**, 2" height x 2" diameter
- 4 **Block**, front bumper (square metal tube)
- 12 **Bolt**, 10mm-1.50 x 80mm
- 8 **Bolt**, 12mm-1.75 x 140mm
- 4 **Bolt**, 3/8"-16 x 3 1/2"
- 4 **Spacer tube**, fan shroud (1/2" OD x 2")

Kit 103

- 12 **Block**, 3" height x 3" diameter
- 4 **Block**, 3" height x 2" diameter
- 4 **Block**, front bumper (rectangular metal tube)
- 12 **Bolt**, 10mm-1.50 x 100mm
- 8 **Bolt**, 12mm-1.75 x 160mm
- 4 **Bolt**, 3/8"-16 x 4 1/2"
- 1 **Extension**, A/T shift linkage (3/8" x 2" rod)
- 4 **Spacer tube**, fan shroud (1/2" OD x 3")

All Kits

- 4 **Bolt**, 1/4"-20 x 1"
- 3 **Bolt**, 5/16"-18 x 1"
- 2 **Bolt**, 5/16"-18 x 4"
- 1 **Bolt**, 3/8"-16 x 1 1/2"
- 1 **Bracket**, fan shroud lower support
- 2 **Bracket**, ground strap ("S")
- 2 **Bracket**, oil filter front
(flat, 3" hole-to-hole; one hole is larger than the other)
- 2 **Bracket**, oil filter rear
(flat, 3" hole-to-hole; holes are the same size)
- 2 **Bracket**, rear bumper
- 1 **Bracket**, spare tire crank tube support
- 1 **Extension**, heater hose (5/8" OD x 3" pipe)
- 1 **Extension**, steering
- 1 **Hose**, brake booster (5/8" x 10")
- 1 **Hose**, fuel filler extension(2" x 5")
- 1 **Hose**, fuel filler vent (5/8" x 18")
- 4 **Hose clamp** (#10)
- 2 **Hose clamp** (#36)
- 1 **Label**, logo
- 1 **Label**, warning to driver
- 1 **Loctite®**, 6ml tube
- 4 **Nut**, 1/4"-20 nylock
- 5 **Nut**, 5/16"-18 nylock
- 5 **Nut**, 3/8"-16 nylock

Qty. Description

All Kits (cont.)

- 1 **Screw**, 3/4" (#12 sheet metal)
- 8 **Washer**, 1/4" SAE
- 10 **Washer**, 5/16" SAE
- 22 **Washer**, 3/8" USS
- 8 **Washer**, 7/16" USS
- 1 **Zip tie**

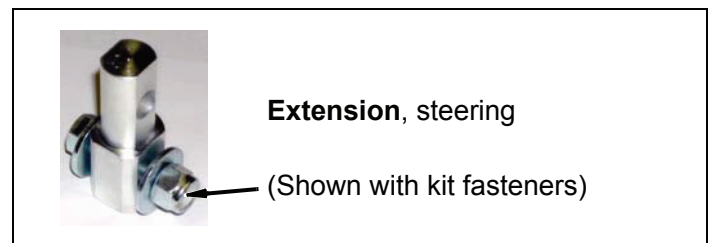
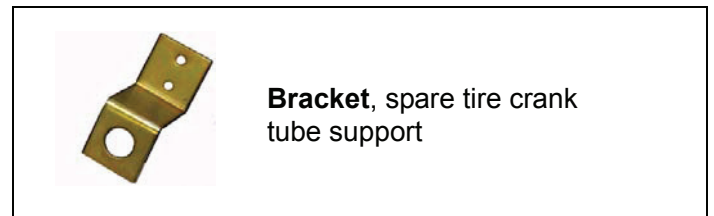
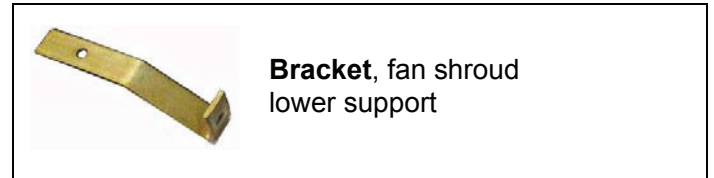

Rev. 2, Copyright 12/04 Performance Automotive Group