

# **PAINLESS**

## **PERFORMANCE PRODUCTS**



## **Wire Harness Installation Instructions**

**Manual for Installing Harness Numbers:**

**20105: 28 Circuit – Classic Customizable Tri-five Chevy Harness**

**Manual 90628**

Painless Performance Products recommends you, the installer, read this installation manual from front to back before installing this harness.

**Painless Performance Products, LLC**  
**2501 Ludelle St.**  
**Fort Worth, TX 76105-1036**  
**PHONE: 800-423-9696 FAX: 817-244-4024**  
**EMAIL: [painless@painlessperformance.com](mailto:painless@painlessperformance.com)**

If you have any questions concerning the installation of this harness, feel free to call Painless Performance Products' Tech Line at 1-800-423-9696. The Tech Line can be reached from 8 A.M. to 5 P.M. central time, Monday through Thursday, and 8 A.M. to 4:30 P.M. on Fridays.

We have attempted to provide you with as accurate of instructions as possible and are always concerned about corrections or improvements that can be made. If you have found any issues or omissions, or simply have comments or concerning these instructions, please write us at the above address, send us a fax at (800) 423 – 9696, or email us at [support@painlessperformance.com](mailto:support@painlessperformance.com). We sincerely appreciate your business.

**Painless Performance Products, LLC** shall in no event be liable in contract or tort (including negligence) for special, indirect, incidental, or consequential damages, such as but not limited to, loss of property damage, or any other damages, costs, or expenses which might be claimed as the result of the use or failure of the goods sold hereby, except only the cost of repair or replacement.

**1<sup>st</sup> Ed. March 2021**

**CAUTION: BEFORE THE REMOVAL OF YOUR ORIGINAL HARNESS AND/OR THE INSTALL OF YOUR NEW PAINLESS HARNESS, DISCONNECT THE POWER FROM YOUR VEHICLE BY REMOVING THE NEGATIVE OR POSITIVE BATTERY CABLE FROM THE BATTERY.**

- A full-color copy of these instructions can be found online at:  
<http://www.painlessperformance.com/manuals/20105.pdf>
- If your vehicle has an existing harness, you will want to retain it for the possible re-use of various pigtails and connector housings particular to your application. During the removal process, avoid making any unnecessary cuts.
- This harness is universal in nature. This means most/all ends are left open to allow you to cut each wire to length and make the appropriate connection. The small parts package and the bag kits with terminals and connectors included with the harness will enable you to make connections.
- Only printed wires have a 900-series number. These 900-series numbers are used to identify various wires and circuits in the wiring diagrams that are a part of these instructions.
- This harness will not support the use of a factory or aftermarket Ammeter.

**If there are unused or unconnected wires, they will need to have their ends terminated with an insulated terminal or electrical tape. Doing so will prevent the wires from shorting and causing harness failure or fire.**

# TABLE OF CONTENTS

<u>PAGE #</u>	<u>SECTION</u>
1	<u>INTRODUCTION</u>
2	<u>CONTENTS</u>
2	SMALL PARTS
3	<u>TOOLS NEEDED</u>
4	<u>TO REMOVE A TERMINAL</u>
5	<u>INSTALLING FACTORY STYLE TERMINALS</u>
6	<u>INSTALLING WEATHER PACK CONNECTORS</u>
7	<u>GROUNDS</u>
8	WHY ARE CLEAN GROUNDS IMPORTANT?
10	<u>FUSE BLOCK</u>
10	HORN RELAY
10	FLASHERS
11	FUSE IDENTIFICATION
12	ACCESSORY PORTS
14	RELAYS & SWITCHES
16	<u>OLD FACTORY HARNESS REMOVAL</u>
17	<u>PRE-INSTALLATION GUIDELINES</u>
21	<u>FUSE BLOCK MOUNTING</u>
22	FIREWALL PADDING
23	1955
24	1956
25	1957
26	<u>HARNESS ROUTING</u>
26	FRONT LIGHT SECTION
26	Engine Compartment – 1955 & 1956
27	Engine Compartment – 1957
28	Wheel Well
28	ENGINE SECTION
28	ON THE INSIDE OF THE VEHICLE
29	TAIL SECTION
31	<u>FRONT LIGHT SECTION</u>
31	LEFT / DRIVER SIDE HEADLIGHT
32	3-prong, Sealed Beam/Sealed Beam Halogen/ H4 Halogen
33	Headlights with Pigtails
34	LEFT TURN / PARK LIGHT
34	Hardwired – 1955 & 1956
35	New Socket – 1956 & Aftermarket
36	Grille Bar – 1957
38	HORN
39	ACCESSORY / FAN RELAY
40	RIGHT TURN / PARK LIGHT & HEADLIGHT
41	<u>ENGINE SECTION</u>
43	COOLANT TEMP SENSOR
44	OIL PRESSURE SENSOR
45	ELECTRIC CHOKE

Continued...

# TABLE OF CONTENTS

<u>PAGE #</u>	<u>SECTION</u>
46	Turbo 400 Transmission
47	COIL
48	Tachometer
51	WIPER MOTOR
52	<u>START / CHARGE SECTION</u>
53	ALTERNATOR
55	GM SI SERIES ALTERNATORS
56	GM CS-130 SERIES ALTERNATORS
58	GM CS-130D SERIES ALTERNATORS
60	GM EXTERNALLY REGULATED ALTERNATOR
61	FACTORY GENERATORS
62	MIDI FUSE
63	STARTER SOLENOID
64	<u>DIMMER SWITCH</u>
64	1955 – 1956
65	1957
66	<u>INTERIOR HARNESS</u>
67	<u>DRIVER COURTESY LIGHT SECTION</u>
67	DRIVER DOOR JAMB SWITCH
68	DRIVER COURTESY LIGHT
70	<u>HEADLIGHT SWITCH</u>
71	1955 – 1956
73	1957
74	PAINLESS UNIVERSAL HEADLIGHT SWITCHES
75	<u>WIPER SWITCH</u>
76	<u>BRAKE SWITCH</u>
76	2-PIN SWITCH
77	4-PIN SWITCH
77	HARDWIRED SWITCHES
80	<u>TURN SIGNAL SWITCH</u>
82	GM COLUMNS / AFTERMARKET GM STYLE COLUMNS
83	EXTERNAL / CLAMP-ON COLUMN MOUNTED SWITCH
84	HAZARD SWITCH
85	HORN BUTTON
86	<u>IGNITION SWITCH</u>
87	FACTORY – 1955 & 1956
88	FACTORY – 1957
89	PAINLESS UNIVERSAL IGN. SWITCH - #80153
90	<u>HVAC PANEL / BLOWER SWITCH</u>
91	1955
91	1956
92	1957
93	AFTERMARKET SYSTEMS
95	<u>REVERSE SWITCH</u>
97	4L60E/4L80E SWITCH

Continued...

# **TABLE OF CONTENTS**

<b><u>PAGE #</u></b>	<b><u>SECTION</u></b>
98	<b><u>NEUTRAL SAFETY / CLUTCH SWITCH</u></b>
99	AFTERMARKET FLOOR SHIFTER
100	<b><u>DASH GROUND</u></b>
101	<b><u>INSTRUMENT PANEL</u></b>
104	FACTORY GAUGES
106	AFTERMARKET INSTRUMENT PANEL
107	HARDWIRING
111	<b><u>AFTERMARKET DASH-MOUNTED GAUGES</u></b>
113	<b><u>RADIO</u></b>
116	<b><u>ACCESSORY SECTION</u></b>
116	ACCESSORIES
117	WIPER SYSTEM
118	CIGARETTE LIGHTER/POWER PORT
118	GLOVE BOX SWITCH
119	POWER WINDOWS AND POWER LOCKS
119	BLOWER MOTOR
120	CLOCK
121	<b><u>PASSENGER COURTESY LIGHT SECTION</u></b>
121	PASSENGER DOOR JAMB SWITCH
122	PASSENGER COURTESY LIGHT
123	<b><u>TAIL SECTION</u></b>
123	DOME LIGHT
124	FUEL SECTION
124	Fuel Sender
125	Fuel Pump
125	THIRD BRAKE LIGHT
126	LEFT TURN / BRAKE / TAILLIGHT
127	REVERSE LIGHT
128	LICENSE PLATE LIGHT
128	RIGHT TURN / BRAKE / TAILLIGHT & REVERSE LIGHT
130	<b><u>TESTING THE SYSTEM</u></b>
131	<b><u>WIRE INDEX</u></b>

# SCHEMATICS

<u>PAGE #</u>	<u>SECTION</u>
14	ACCESSORY RELAY 12-VOLT ACTIVATION
15	ACCESSORY RELAY GROUND ACTIVATION
15	FAN RELAY GROUND ACTIVATION
37	'57 TURN/PARK LIGHTS CONNECTOR
39	FAN RELAY 12 VOLT ACTIVATION
39	FAN RELAY GROUND ACTIVATION
40	FRONT LIGHT SECTION
42	ENGINE SECTION
46	CHOKE & TH400 TRANSMISSION
49	COIL CONNECTIONS (NO BALLAST RESISTOR)
49	BALLAST RESISTOR CONNECTIONS
50	HEI COIL ON CAP CONNECTIONS
50	MSD IGNITION CONNECTIONS
52	CHARGE / BATTERY POWER
55	10-SI ALTERNATOR
57	CS-130 ALTERNATOR
59	CS-130D ALTERNATOR
60	EXTERNAL VOLTAGE REGULATOR
61	GENERATOR CHARGING SYSTEM
63	GM STARTER CONNECTIONS
65	HEADLIGHT DIMMER SWITCH (1955 – 1956)
65	HEADLIGHT DIMMER SWITCH (1957 & GM AFTERMARKET)
69	COURTESY LIGHTS
71	HEADLIGHT SWITCH & DIMMER SWITCH
72	1955 HEADLIGHT SWITCH
72	1956 HEADLIGHT SWITCH
73	1957 HEADLIGHT SWITCH
74	PAINLESS HEADLIGHT SWITCH #80151
74	PAINLESS HEADLIGHT SWITCH #80154
79	TURN SIGNAL SWITCH & BRAKE SWITCH
81	1956 TURN SIGNAL SWITCH
81	1957 TURN SIGNAL SWITCH
83	EXTERNAL / CLAMP-ON COLUMN MOUNTED SWITCH
84	3PST ON-OFF HAZARD SWITCH
84	SPST ON-OFF HAZARD SWITCH (BRAKES ONLY)
86	IGNITION SWITCH
87	'55 – '56 IGNITION SWITCH
88	'57 IGNITION SWITCH
89	PAINLESS UNIVERSAL IGNITION SWITCH - #80153
90	'55 – '56 HEATER SWITCH CONNECTIONS
93	'57 HEATER SWITCH & RESISTOR CONNECTORS
94	A/C SYSTEM w/ TRINARY SAFETY SWITCH
97	EARLY 4L60e/4L80e NSS/REVERSE SWITCH
97	LATER 4L60e/4L80e NSS/REVERSE SWITCH
100	GROUND SPLICE LAYOUT
103	INSTRUMENT PANEL
105	'55 – '56 INSTRUMENT PANEL
105	'57 INSTRUMENT PANEL
107	POWERING AFTERMARKET GAUGES (SPLICING)
107	POWERING AFTERMARKET GAUGES (CHAINING/JUMPING)
108	GROUNDING AFTERMARKET GAUGES (SPLICING)

Continued...

# **SCHEMATICS**

<b><u>PAGE #</u></b>	<b><u>SECTION</u></b>
108	GROUNDING AFTERMARKET GAUGES (CHAINING/JUMPING)
109	AFTERMARKET GAUGE LIGHT POWER (SPLICING)
109	AFTERMARKET GAUGE LIGHT POWER (CHAINING/JUMPING)
110	AFTERMARKET GAUGE SENDER WIRES
112	AFTERMARKET GAUGE CONNECTOR
114	RADIO
115	ACCESSORY SECTION
116	ACCESSORY RELAY 12-VOLT ACTIVATION
117	ACCESSORY RELAY GROUND ACTIVATION
129	TAIL SECTION





# INTRODUCTION

Thank you for your purchase of a Painless Performance Products harness. This is a customizable harness; therefore, we suggest you retain your original harness for any unique plugs or connectors you may need while installing your new harness.

The fuse block is pre-terminated, and the proper fuses for each circuit are pre-installed. All wires are colored based on GM color codes. Also, each wire is marked with a 900-series wire number, what section the wire is in, and the wire's function. These 900-series numbers are assigned by Painless and do not correspond to any circuit numbers found on any factory wiring schematics. A Wire Index is located on [page 131](#) and provides a quick reference guide for the individual wires of this harness. The Wire Index identifies the gauge, color, what's printed on the wire, and point of origin for each wire.

During this manual, you will notice wires with a slash (Ex. **BLUE/WHITE**). This indicates a wire with a stripe. The first color listed is the main wire color, and the second color will reference the stripe color. Therefore, the **BLUE/WHITE** example will be a **BLUE** wire with a **WHITE** Stripe.

Do not let the length of this instruction manual intimidate you. Much of the information contained in this manual is helpful information about each wire, where the wire comes from, where it goes, why a component needs it, etc. In many cases, there are multiple schematics as well as alternate connection options for the same wire/connection point due to this being a customizable harness. You will find that the actual install portions of this manual are pretty straightforward and easy to follow.

Individual components and sections are tied together for easy routing of the harness. GM color-coded wires, along with the schematic diagrams found throughout this manual and the printed circuit numbers and description printed on the wire, will help you identify the different circuits during installation and later on if additions to the overall system are necessary.

As you read through this installation manual, prior to installing your new harness, you will find blank areas titled NOTES in each section and the back of the manual. You may find these sections beneficial for taking notes, listing components you are connecting to on your vehicle, and the factory or manufacturer wires that are coming from the component. You can then use the text in the manual and the wire index in the back of the manual to identify the wire and circuit number in the Painless harness that will connect to that requirement. For example, a turn signal switch for a 1966 Impala:

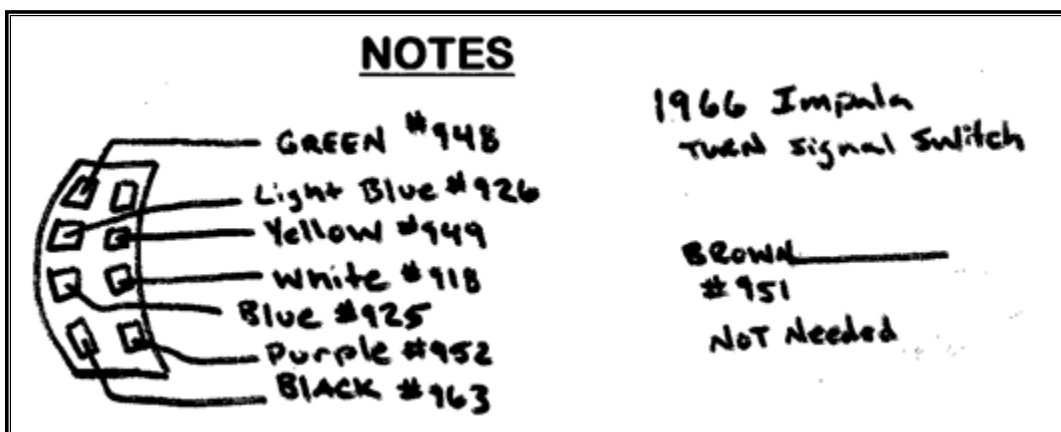

# CONTENTS

Refer to the **Contents Figure** (below) to take inventory. See that you have everything you're intended to have in this kit. If you find that anything is missing or damaged, please contact the dealer where you obtained the kit or Painless Performance at (800) 423-9696.

## The Painless Wire Harness Kits 20105 should contain the following:



- 27 Circuit fuse block and harness.
- Mounting Bracket
- (2) Parts Kits: loose piece terminals & fuses
- Parts bag: (2) headlight pigtails, multiple plastic connectors, rubber grommets, MIDI fuse w/ holder, (2) flashers, zip-ties
- Parts bags labeled: "ALTERNATOR," "FRONT," and "TAIL"
- Power Cable w/ terminals & boot
- Sub-harnesses: 1957 Front Turn Signal Harness, factory cluster harness, universal cluster harness, clock pigtail
- PVC sleeves
- This manual: 90533

## SMALL PARTS

This Painless harness includes several parts kits containing a variety of terminals, fuses, and screws. Many of the terminals are non-insulated and require heat shrink to be applied after the terminal is properly crimped. Heat shrink is supplied with this kit.

These non-insulated terminals allow you to keep a cleaner, more factory look; colored insulated terminals can look out of place. When crimping these terminals, take notice of the split in the terminal. Always make sure the split in these non-insulated terminals is facing the groove.

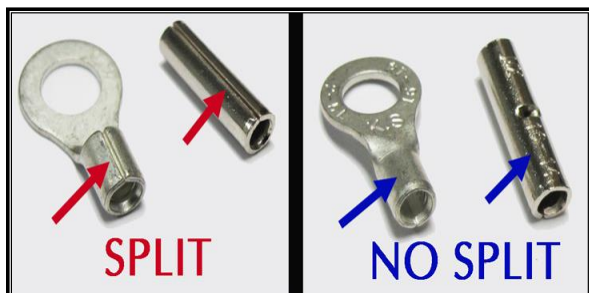

## TOOLS NEEDED

In addition to your regular hand tools, you will need, at least, the following tools:

- **Wire Crimping and Stripping Tools:**

This style of hand crimper can be purchased from just about any local auto parts store, home improvement store, or can also be purchased online. You will need this style of crimper to crimp the heat shrinkable and non-heat shrinkable, insulated terminals included in the small parts kit.

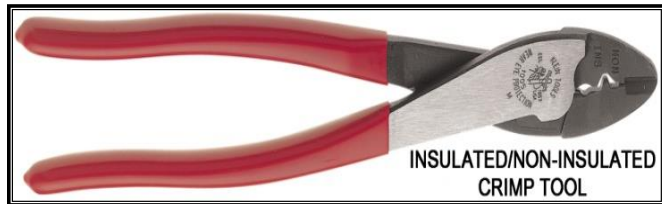

Another style of crimpers is "Jaw Crimpers" or "Roll-Over Crimpers." These crimpers will crimp factory-style, non-insulated terminals. These types of terminals are provided in the kit for connecting to an HEI distributor, headlights, and a factory-style alternator. Painless offers "Jaw Crimpers," such as those seen to the right, under Painless [part #70900](#).

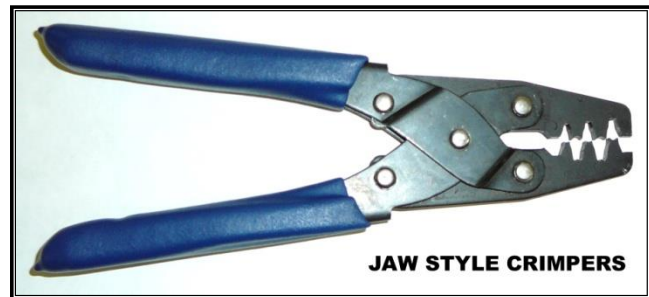

A good set of wire strippers is required to strip wire properly. This style of wire stripper is ideal for this harness install because of its ability to properly strip wire gauges 10 to 20. These are available from just about any local auto part store, electrical supply shop, home improvement store, or can be purchased online. [P/N 72030](#).

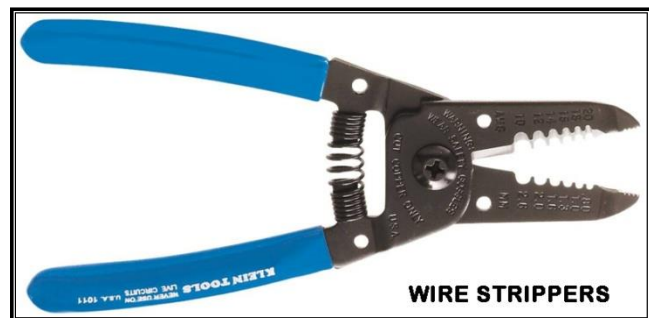

- **Volt/Ohm Meter:**

A Volt/Ohm meter is always a good tool to have on hand when installing any type of electrical component in a vehicle. Most basic units provide the two functions required to diagnose electrical issues seen during a harness install. These two functions are the ability to read DC Voltage and electrical continuity or Ohms. They can be purchased from any home improvement store, local hardware store, electrical supply shop, and online.



- **Electric Drill & Drill Bits:**

A drill and bits are needed in order to mount the MIDI fuse holder and the fuse block.

- **Heat Gun:**

Very useful to shrink the heat-shrinkable terminals found in the parts kit.

- **Small (10 amp or less) Battery Charger**

See **TESTING THE SYSTEM** located on [page 130](#).

- **Factory Wire Schematic**

This isn't absolutely necessary; however, having one handy is good practice with any electrical job.



## **TO REMOVE A TERMINAL**



- Notice the locking tang that holds the terminal in the connector. Locate the tang access slot on the terminal end of the connector. Push a paper clip, stiff wire, or a small flat head screwdriver into the slot to depress the locking tang on the terminal.
- Once depressed, pull the harness wire from the connector. Do not pull too hard or you could pull the wire out of the terminal; this leaves the terminal stuck in the connector.

# **INSTALLING FACTORY STYLE TERMINALS**

In the parts kit, you will see different uninsulated male and female terminals. These terminals are for factory-style connections and require roll-over crimpers.

- Strip about  $\frac{1}{4}$ " of insulation off of the wire.

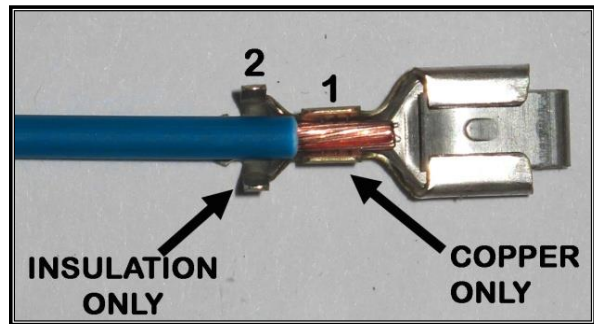

- Insert the wire into the terminal. There are two terminal straps on the terminal. For instructional purposes, we will label them 1 and 2. Strap 1 crimps the exposed copper strands of the wire, while strap 2 crimps the wire insulation. Make your strip length long enough to ensure only copper strands are crimped by Strap 1 but short enough that only insulation is crimped by Strap 2. The photo to the right best demonstrates this.



- Using the appropriate jaw on the crimpers, crimp Strap 1. The appropriate jaw depends on the wire gauge as well as the terminal stiffness. If you are unsure which jaw to use, you can always start with the biggest and work your way down until you get a tight crimp.



- With Strap 1 crimped, move onto crimping the insulation strap: Strap 2. Place Strap 2 into the appropriate jaw of the crimpers. This jaw will be larger than the one used to crimp the first strap. Crimp down on Strap 2 making sure the strap folds down into the wire, and not overlapping itself. Refer to the drawing to the right. Overlapping could cause problems with the terminal fitting into the factory connector.

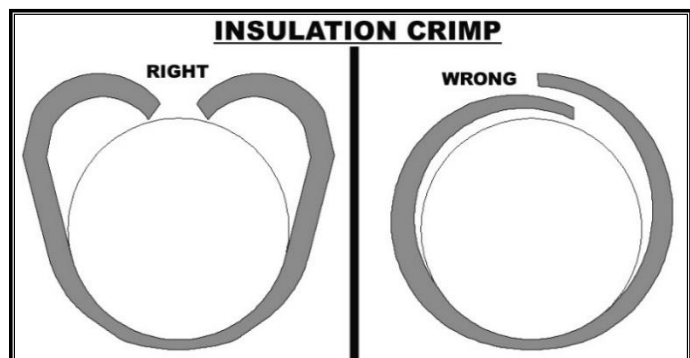

# INSTALLING WEATHER PACK CONNECTORS

Weather Pack connections involve the five parts you see to the right:

1. Male connector
2. Female connector
3. Female Terminal
4. Male Terminal
5. Cable seal

The male connector requires the female terminals and vice versa.

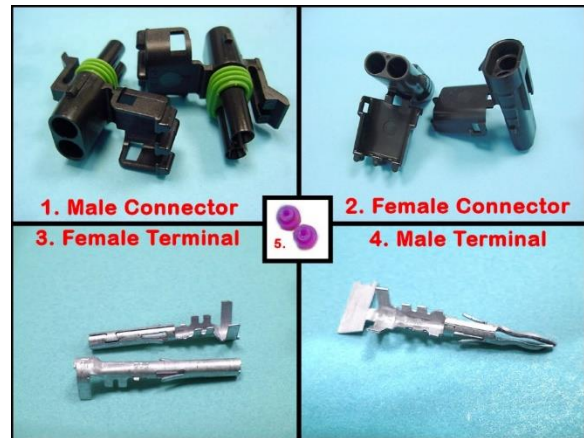

- First, slide the cable seal over the wire with the smaller half facing the end of the wire. The terminal straps will crimp (see the previous page) over the smaller portion of the cable seal.
- Strip  $\frac{1}{4}$ " of insulation from the wire and crimp on one of the terminals. Which one you use will depend on the connector you're using. Remember, male terminals for the female connector and vice versa.



- With the terminal and seal installed slide the wires into the connector the close the cap on the connector to lock the wires in place.

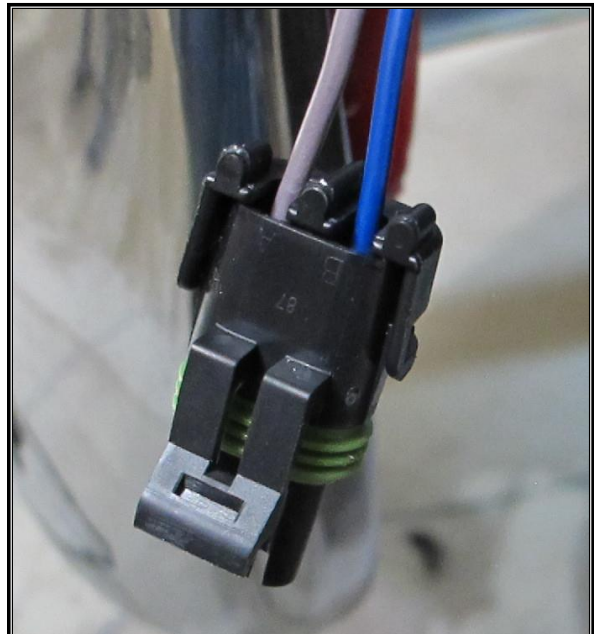

# GROUNDS

Throughout this instruction manual, and when looking at the Painless harness, you will see the word GROUND. Maybe you have seen the ground symbol on wiring diagrams before? What exactly is a ground and why do you need it?

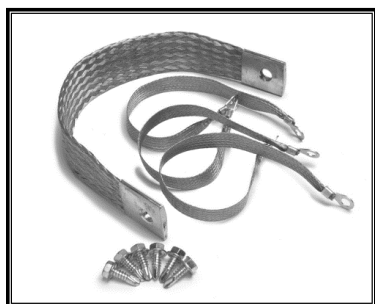
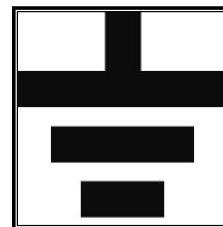

You have probably noticed the large cable coming from the negative side of your battery going down to the frame or the engine. This cable allows voltage to get back to the battery through the metal of the frame and all the other metal pieces bolted to the frame. It is also important to have ground cables going from the frame to the engine and from the frame to the body.

A ground is simply the common path electrical current follows back to the battery. A ground, or chassis ground as it is often called, is any bare metal surface found on the vehicle which is in turn connected back to the frame/negative side of the battery through mounting points and ground straps. Grounds are needed for the electrical current to complete the circuit.

There are two ways components are grounded in vehicles: through mounting or a wired connection.

Some grounds are supplied through mounting of the metal housings in which bulbs are installed, like turn signal or taillight housings. Components with plastic housings or non-conductive housings, like headlights which are glass, get their grounds through wires from the chassis harness.

Make sure all mounting points are clean by removing any dirt, corrosion, and/or paint. This includes light housings that ground through mounting them and the harness ground wire connection point. This is especially important for cars that have recently been painted as paint build-up will cause grounding issues. 80 grit or courser sandpaper should be all that's needed to properly clean grounding points. Star-washers are recommended, especially in painted areas, to help bite through to the bare metal.



# GROUND STRAPS

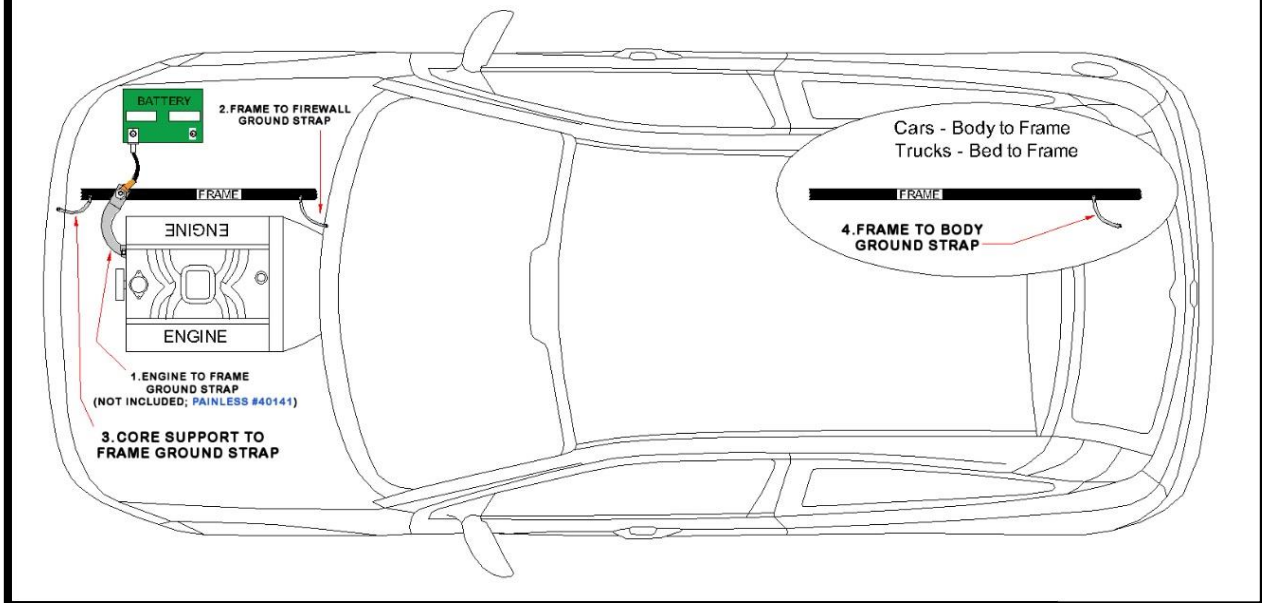

## WHY ARE CLEAN GROUNDS IMPORTANT?

As an example, we will use a front turn signal that also functions as a park light. Follow the red line from right to left in the diagram below. This red line indicates the path the electrical current takes when everything is properly grounded. The diagram on the next page represents when the ground is bad. Notice which bulbs illuminate when good and bad grounds are present.

In our park light example with a good ground source, current travels from the headlight switch to the park light bulb element. Since the bulb is properly grounded, the current passes cleanly through the bulb causing it to illuminate, and the current exits the bulb through the ground source back to the battery. The ground allows everything to work properly without any issues.

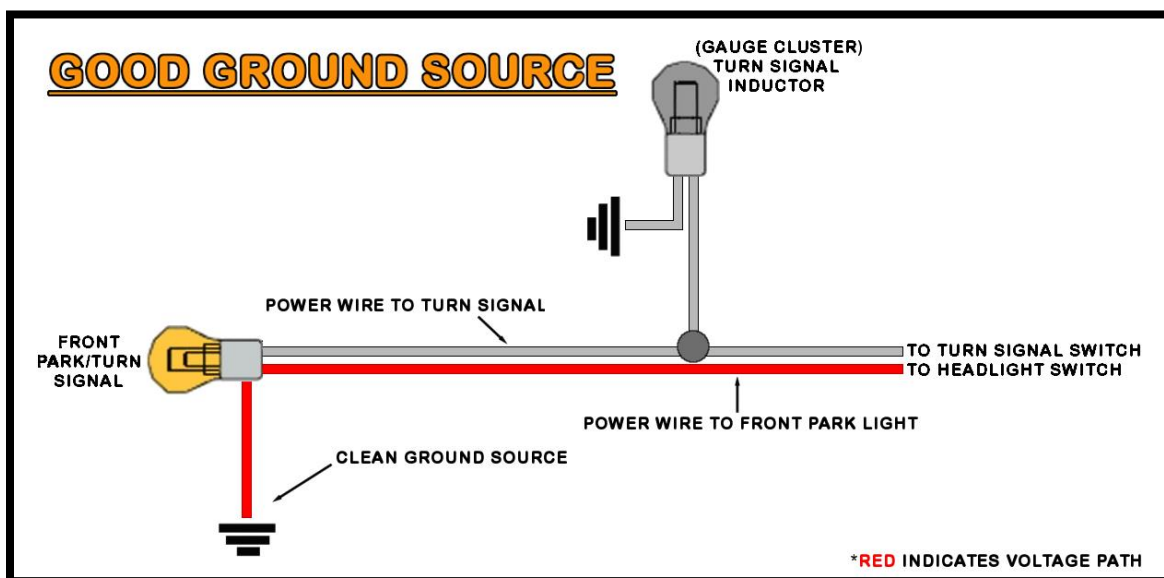

When a ground is not connected properly or is contaminated with dirt, corrosion, or paint, the current will then find the easiest path to ground. This is represented in the diagram below.

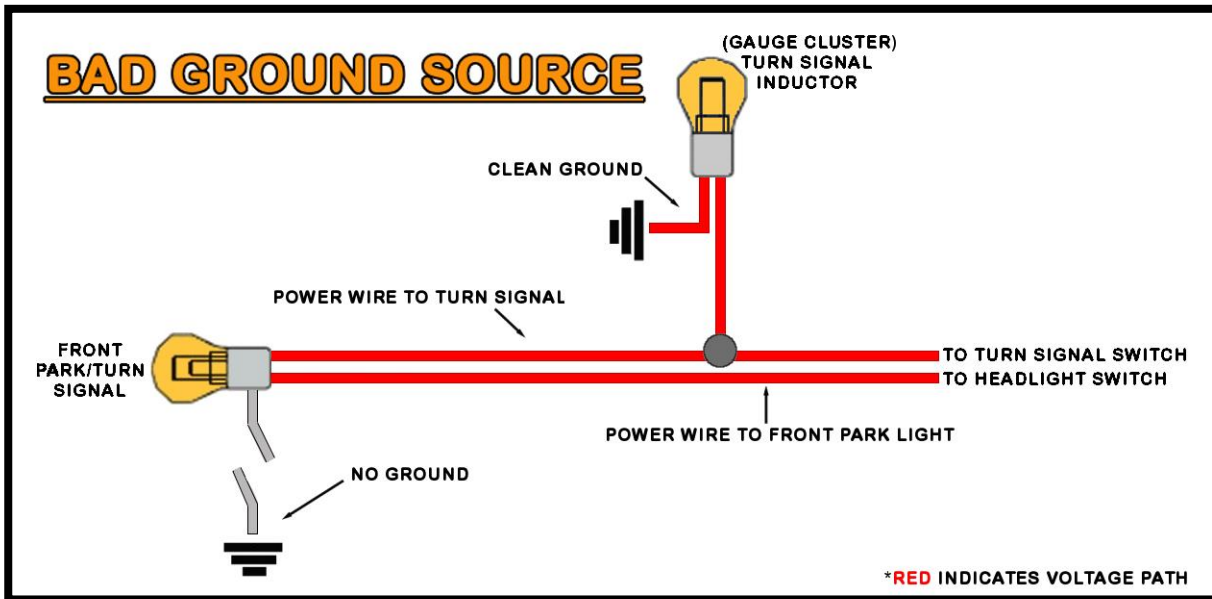

Current travels from the headlight switch to the park light bulb element, but wait: there is no ground at the bulb. Since the ground it normally uses is not there, the current finds another path to ground and back to the battery. When this happens, things that should not have power receive power coming from the park light bulb. Since the turn signal wire also goes to the bulb, the current will travel out of the bulb through the turn signal wire. Notice this bad ground at the front park/turn signal bulb can cause issues on the interior of the vehicle at the turn signal indicator on the dash. In this case, the turn signal indicator light is illuminated when it should not be. Also, since this one power source which was only supposed to power 1 bulb is now powering 2 bulbs, both bulbs may be dimmer than they would be if everything was grounded properly. This is one of the problems with diagnosing a bad ground: they can cause issues throughout the entire vehicle.

# FUSE BLOCK

Your Painless harness contains a pre-terminated fuse block that uses modern ATC blade style fuses. There are 17 fuses controlling 27 circuits. This fuse block allows the convenience of having both flashers (turn signal and hazard), as well as the horn relay, all mounted in one location.

## HORN RELAY

On the fuse block, you will find a horn relay that replaces the factory core support/firewall mounted horn relay found on many older vehicles. The fuse block mounted horn relay uses a standard 30-amp SPST relay and is ground activated from a wire in the Turn Signal Switch group of wires. Replacement relays for the horn relay can be found at any auto parts store or by ordering [Painless part number #80131](#).

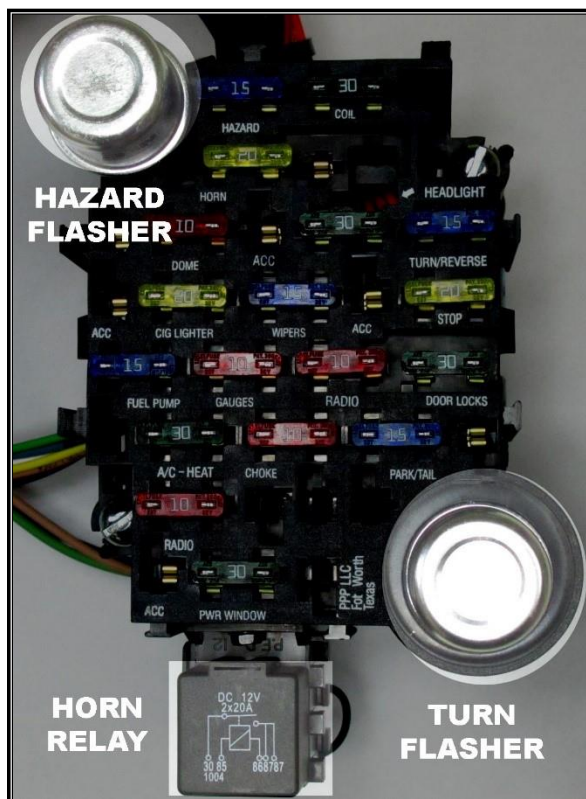

## FLASHERS

The two flashers simply switch power on and off going to the turn signal switch and hazard switch. The flasher on the right is the hazard flasher. The flasher on the left is the turn flasher.

How a flasher functions is simple. Power is switched off and on according to the amount of heat built up in the resistance wire inside the flasher. As soon as the current is drawn through the flasher, as when the turn signal or hazard switch is activated, the resistance wire heats up and makes contact with the output side of the flasher. This contact passes power through the flasher, into the switch, and to the turn signal lamp(s). Once this contact is made, the resistance wire is no longer resisting any current, so it begins to cool; this cooling causes the flasher to lose contact. This loss of contact means that there is no longer any current going to the switch, causing the turn signal light to turn off. Once contact is lost, the resistance wire begins heating up and the entire process starts over again until the turn signal switch or hazard switch is disengaged.

Some LED turn signals do not draw enough current to activate a typical thermal flasher. If you are using LED turn signals, and your turn signals do not work properly and you are certain everything is connected properly, a no-load flasher will be required ([Painless part number #80230](#)).



## FUSE IDENTIFICATION

The following two diagrams and information will detail each fuse and which components/circuits each fuse powers.

The drawing on this page shows all the switched ignition fuses. These fuses are powered by wires coming from the ignition switch (wires #932, #933, and #934) and receive power depending on what position the ignition switch is in. **NONE OF THESE FUSES SHOULD HAVE POWER WHEN THE IGNITION IS IN THE OFF POSITION.**

The Ignition Switch Section beginning on [page 86](#) of this manual will go into further detail about the power supplied to these fuses.

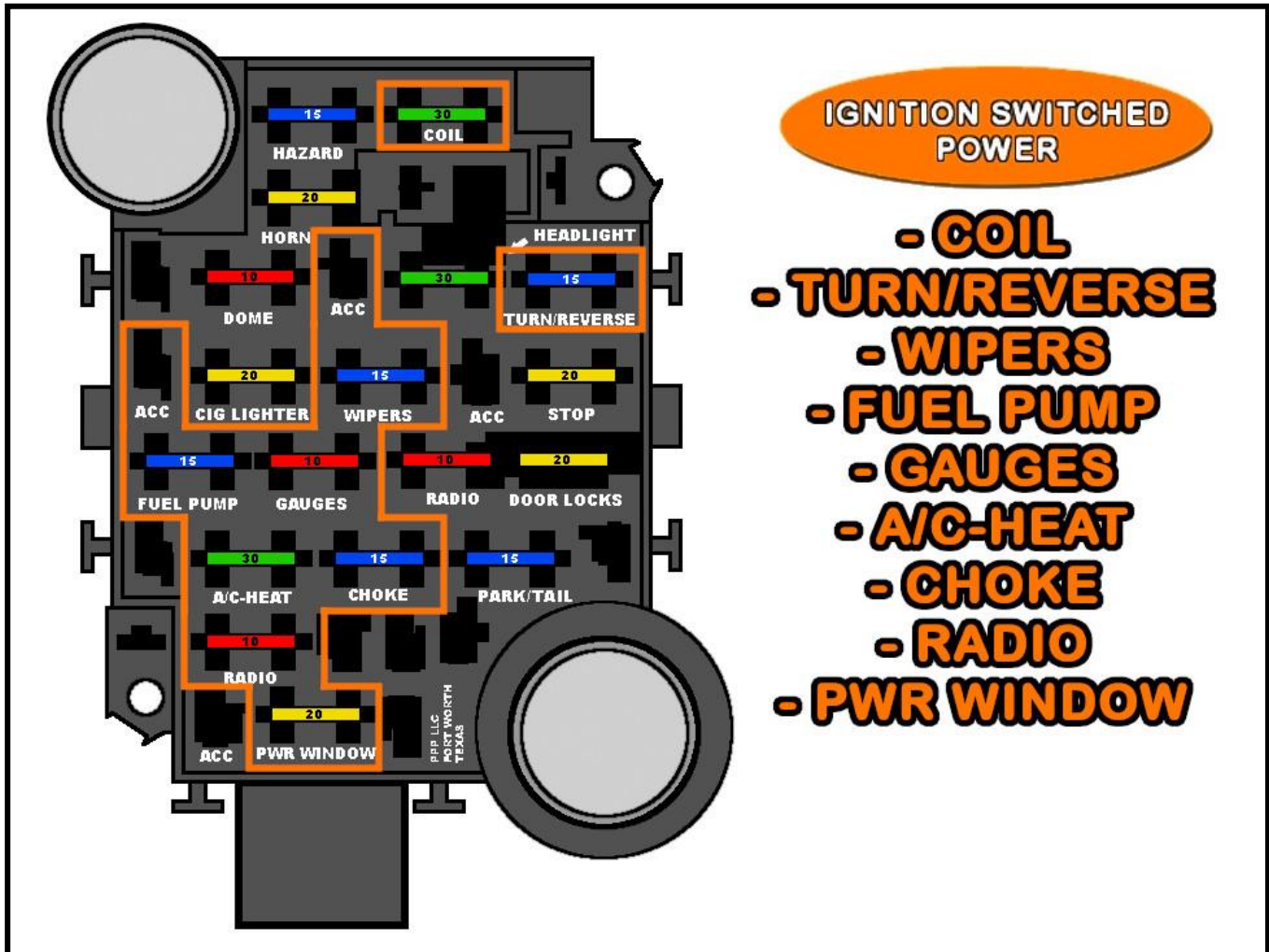

The drawing below shows all the battery power fuses. These fuses are powered by a wire that comes from the large power splice, seen on [page 52](#). The battery power fuses have power at all times.

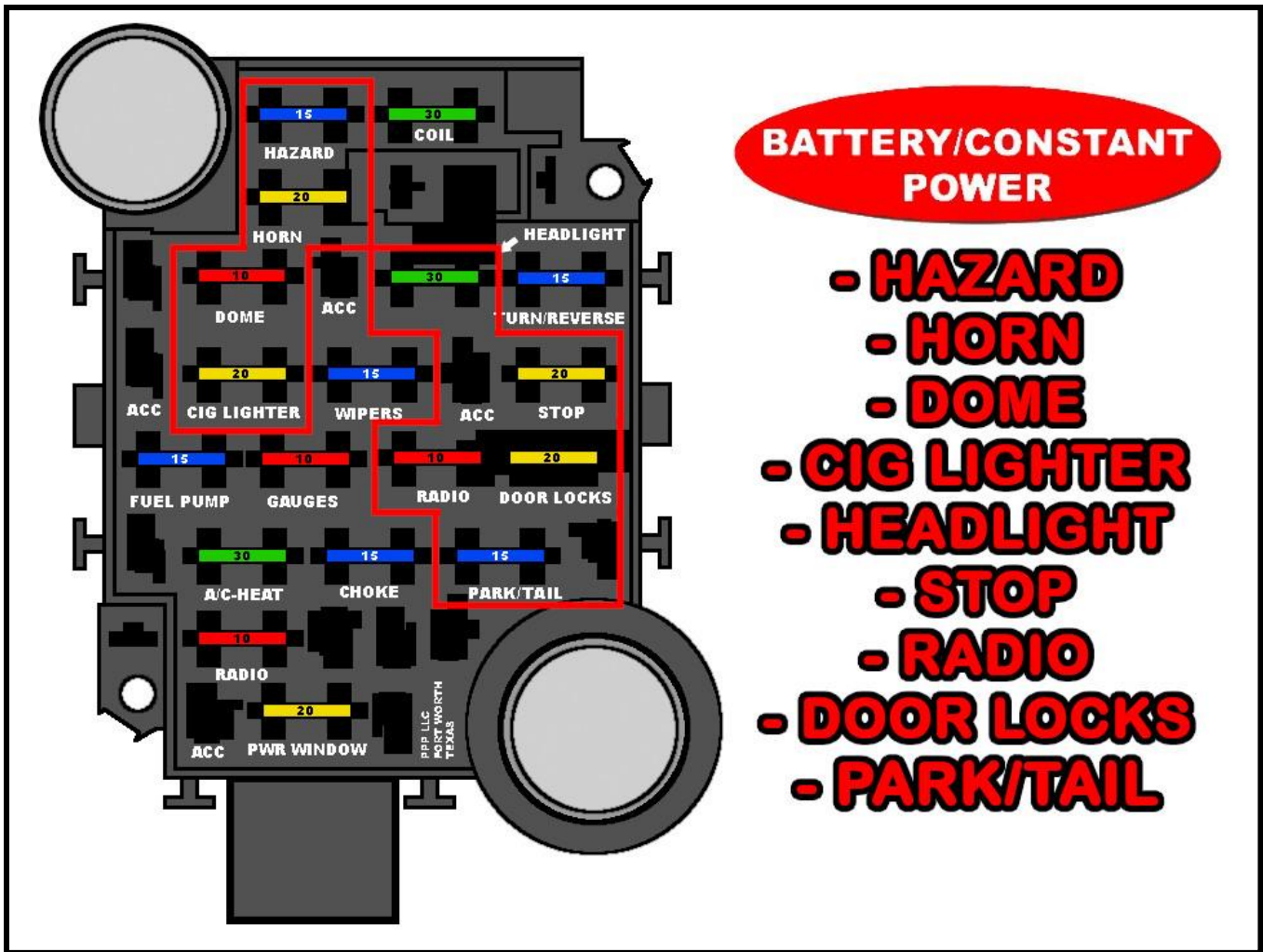

## ACCESSORY PORTS

You will notice 4 single open power ports on the front of the fuse block. These ports give you access to constant power and switched power for extra circuits you may need now or in the future.

Terminals and connectors, seen to the right, are provided in the parts kit to allow you to tap into these extra sources. Since each of these ports is keyed differently, simply shave the key on the connector off to allow connection into any port. The ignition power ports, shown below in PINK, are all un-fused power sources and must have an inline fuse, no larger than 10 amps, installed before being routed to a component needing power. The ports identified with RED are battery-powered and are fused as indicated on the drawing. Anything needing more than 10 amps will need to have a relay installed. See relay wiring and activation on the next page for details.

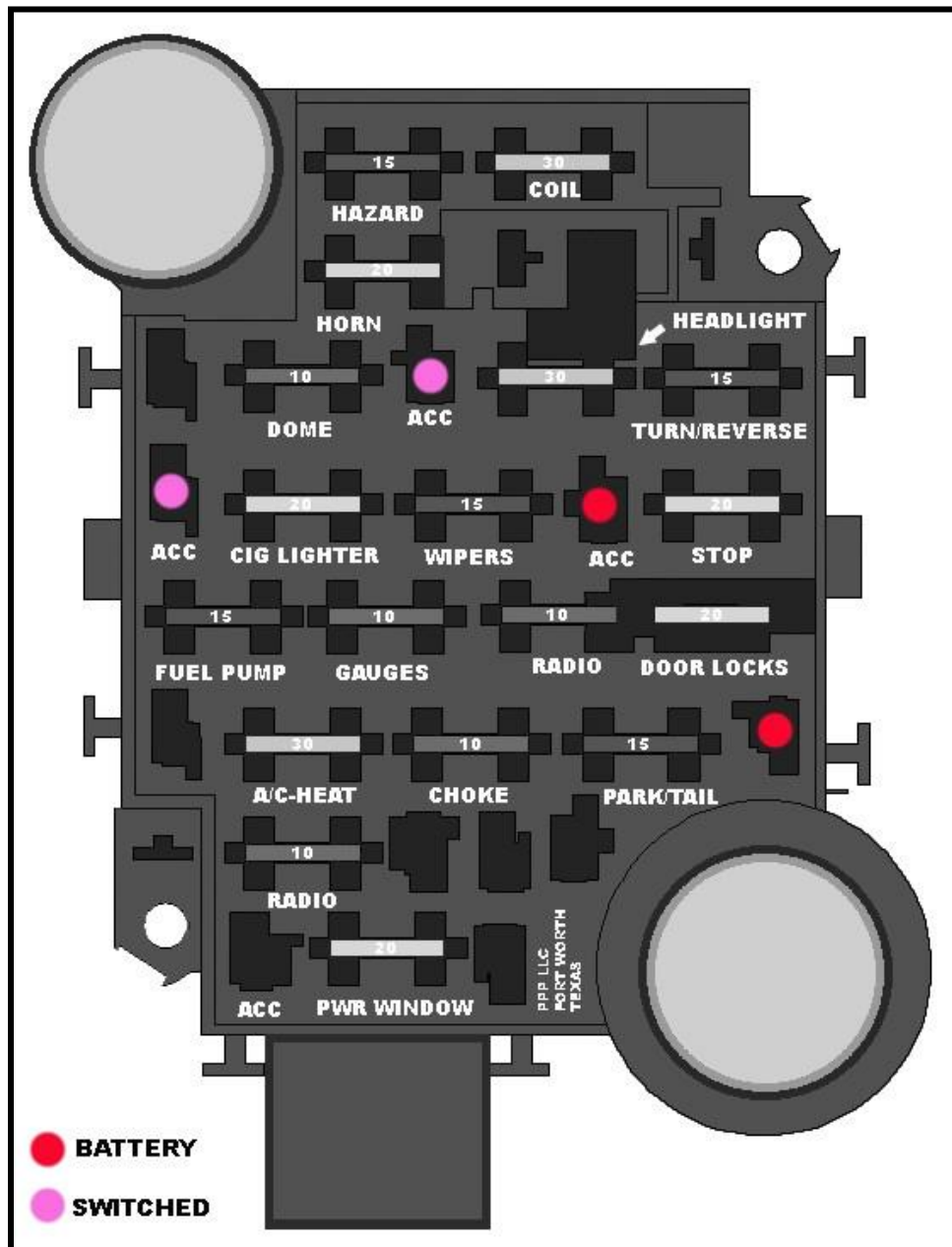

## RELAYS & SWITCHES

All ACCESSORY wires found in this harness can support up to 15 amps alone. Components requiring more amperage will need to be connected to a relay. The amount of amperage needed by the component will determine the size of the relay and circuit breaker needed. An ACCESSORY wire can be used as a 12-volt activation source or a 12-volt source for ground activation in these circumstances. *Take a look at [Painless Relay Banks \(part #'s 30107 & 30108\)](#) or [Painless Single Relays \(like part #'s 80130 & 80131\)](#) to fill your relay needs at [www.painlessperformance.com/webcatalog/relay](http://www.painlessperformance.com/webcatalog/relay).*

A 12-volt activated relay is constantly grounded. As the name implies, the relay sends power from the output side of the relay to the component being powered when 12 volts is applied. The 12-volt source can be wired directly to the relay or interrupted by a switch, as shown in the *12 VOLT SOURCE ACTIVATION* drawing.

Wiring directly to the relay, as indicated by the dashed line, would be used in the case of wiring a water pump relay or any other high amperage component you would want to run continuously while the key is in the on position. In these cases, make certain the 12-volt wire you are using is an Ignition Switched 12-volt wire and not a battery constant hot.

The 12-volt activation wire can also be wired to a switch to offer the user OFF/ON capabilities. In these situations, a constant battery power source would be used. This would allow a component to be turned OFF or ON without the key in the ON position.

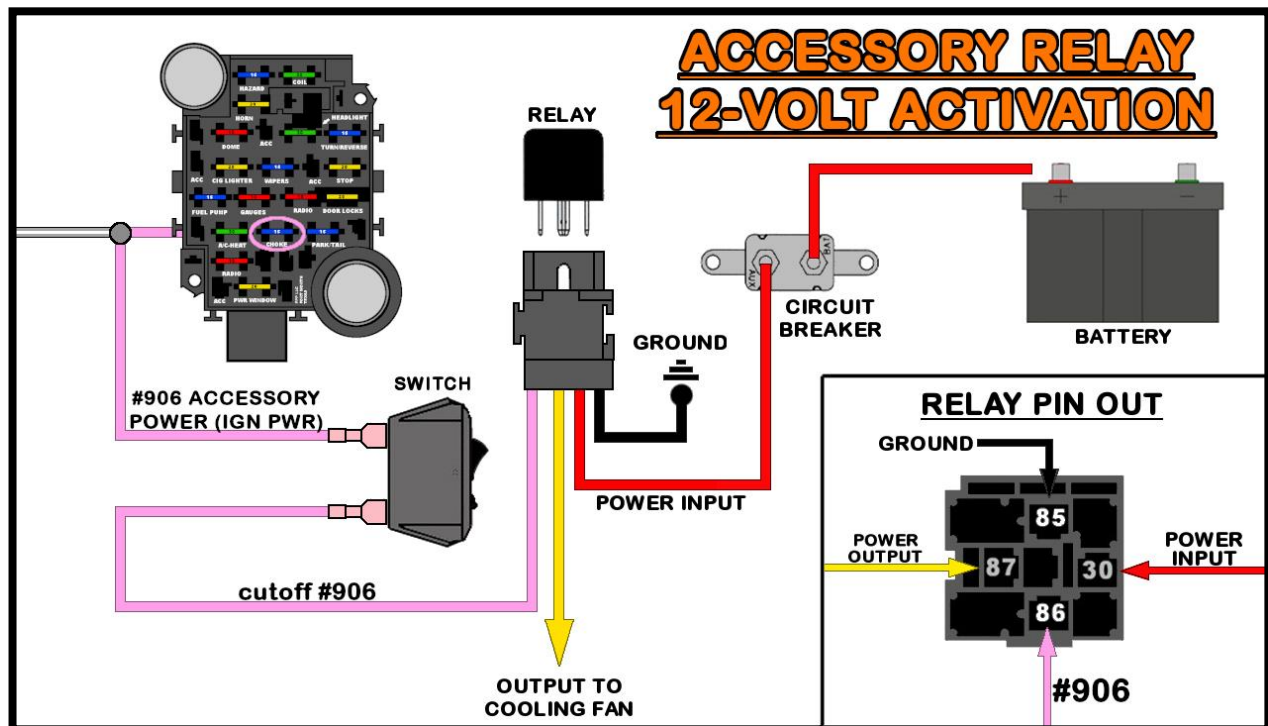

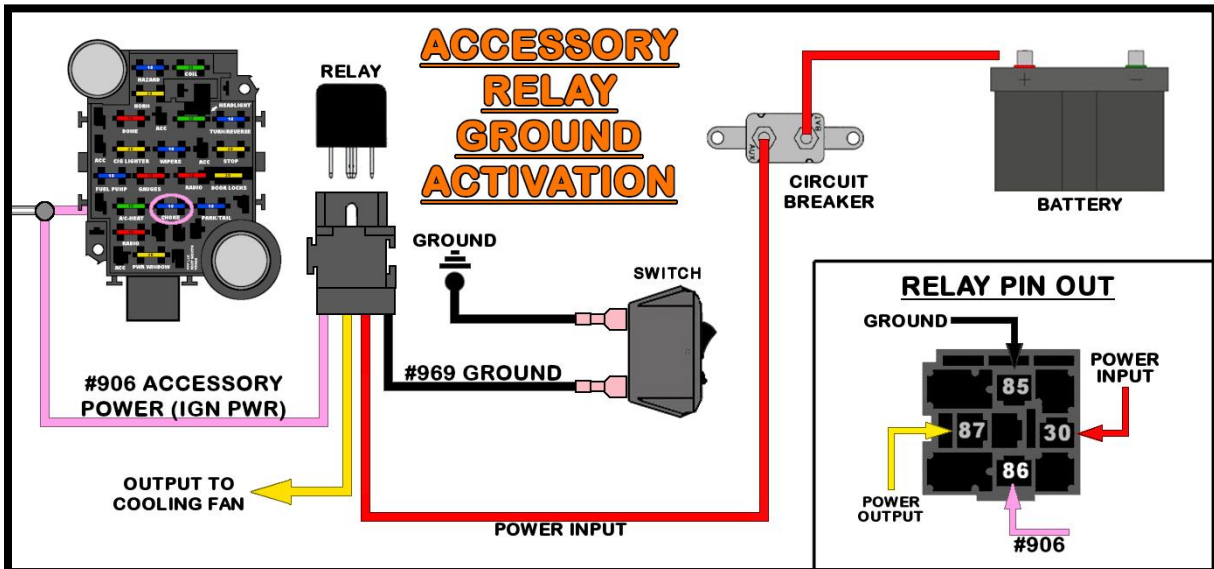

A ground-activated relay is just the opposite of the 12-volt, activated relay; 12 volts (battery constant or switched) is supplied uninterrupted and the ground wire is switched. The Horn Relay pre-wired in the Painless harness is a Ground Activated Relay. Another example of this method is a thermostat-operated fan relay. In this case, however, a thermostatic switch would replace the switch in the drawing above (see below).

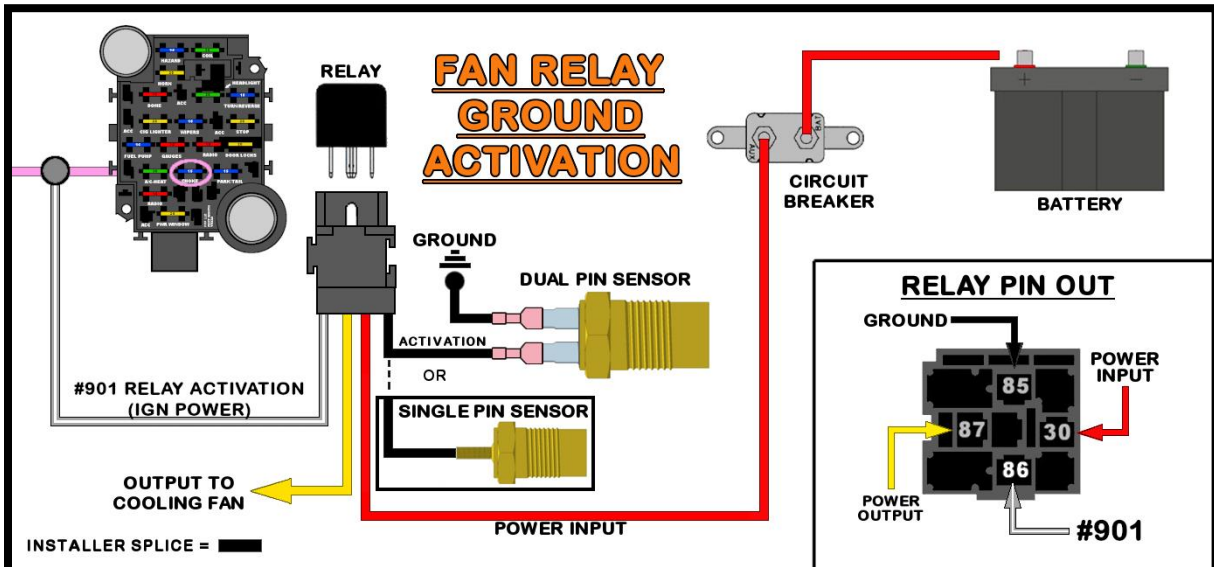

**IF A TOGGLE/ROCKER SWITCH IS BEING USED WITHOUT A RELAY, MAKE SURE THE AMPERAGE OF THE COMPONENT YOU ARE POWERING DOES NOT EXCEED THE CAPABILITIES OF THE SWITCH OR SWITCH FAILURE WILL OCCUR. IF YOU NEED A RELAY KIT [PAINLESS OFFERS PART #'S 30128, 30128, & 30130.](#)**



# **OLD FACTORY HARNESS REMOVAL**

During the removal of the old, factory harness, avoid making any unnecessary cuts to any wires. The entire harness should be able to come out of the vehicle without any cutting at all unless someone has modified connections.

Labeling the factory harness is highly suggested as it may be helpful to look back at the factory harness during the install of the new Painless harness. Plus, taking this step helps you identify anything that may not be included in the Painless harness and will need to be re-used. Individual wires and connectors can easily be labeled using masking tape.

Take photos or make a drawing of any connections that have multiple connectors, like the wiper motor, wiper switch, radio, etc., to help with reconnecting the new harness.

## **Cars with aftermarket heat, air conditioning, power locks, and/or windows:**

These accessory harnesses do not need to be removed during the removal process. They are generally separate harnesses. The power supplies for the separate harnesses simply need to be disconnected. They are usually plugged into the front of the factory fuse block or on the factory horn relay.

To aid in the removal and installation of the harness, removal of the rear bench seat, driver side rear trim panel, driver side sill plate, and driver side kick panel will be required. Some may find removing the front bench or driver-side bucket seat allows more maneuverability inside the vehicle during the factory harness removal, new fuse block mounting, and new harness routing.

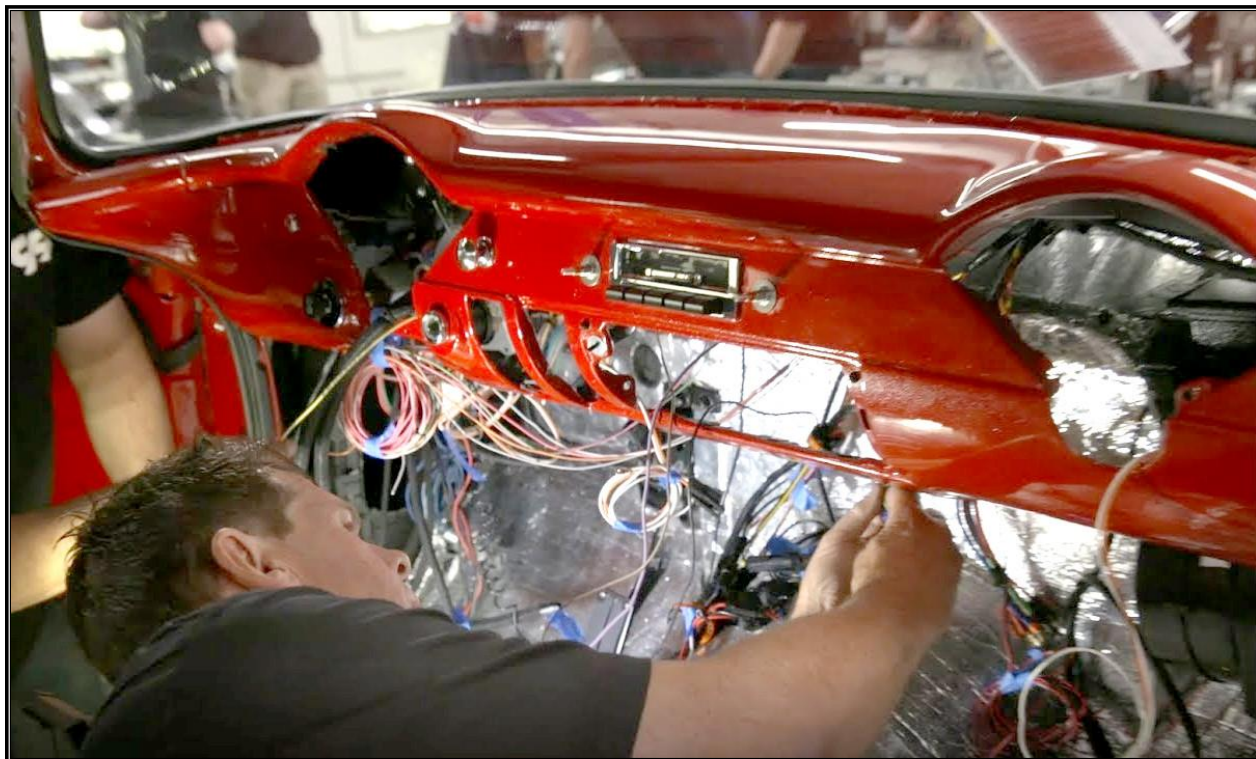

# **PRE-INSTALLATION GUIDELINES**

## **Learning your new harness:**

Before moving your harness into your vehicle, it is a good exercise to lay the entire harness out next to your vehicle. This will allow you to identify all sections of your new Painless harness. Wires are marked to help ease the process of routing.

You will note when you pull the harness out of the box that it is organized and twist-tied into **three main sections**. These sections are:



- **ENGINE/HEADLIGHT SECTION:**

The Engine Section consists of wires for connections such as oil pressure and coolant temperature sending units, coil or ignition system connections, and a wire for an electric choke on a carburetor.

The headlight section consists of wires for turn signals, parking lamps, headlights, horn power, dimmer switch, and a 12-volt activation wire that can be used for a fan relay.

All wires of the engine/headlight section have ample length to account for the numerous ways components can be mounted inside of an engine compartment. This will allow you to route your wires cleanly and terminate at the length you find fits your build best.

- **INTERIOR SECTION:**

The Interior Section consists of wiring for the interior of the vehicle. This includes wiring for your ignition switch, blower switch, headlight switch, turn signal switch, radio power, courtesy lights, instrument panel, and aftermarket gauges.

- **TAIL SECTION:**

The Tail Section consists of wiring for taillights, brake lights, rear turn signals, dome lights, electric fuel pump, fuel sending unit, amplifier, third brake light, and backup lights.

## **DO NOT SKIP THESE PRE-INSTALLATION STEPS**

- **Front Light Section:** If you have a **1955** model, reroute the **Front Light Section** to exit the bottom of the Fuse Block.
- **GREY/WHITE #901** in **Front Light Section** will provide an accessory relay, like a cooling fan relay, a switched ignition 12v activation source. **THIS IS NOT A POWER SOURCE FOR THE RELAY, ONLY AN ACTIVATION SOURCE.** If a relay is to be mounted on the core support make certain to route this wire to that location.
- If you are running mechanical gauges, or if you are using an aftermarket gauge cluster or individual gauges that require their own 2 or 3-wire sensors, you can remove the sending unit wires running from the **Engine Section** to the **Instrument Panel Section**.
- **Choke: RED #954** found in **Engine Section** can also be pulled back to the fuse block if you have a mechanical choke or if you are running fuel injection. As previously stated, **Painless does not recommend removing any power wires from the fuse block as they can be used to power other things.**
- **External Voltage Regulator:** If you are using a charging system that requires an external voltage regulator take notice of its mounting location. If you find that the regulator is mounted on the core support you may want to re-route the **BROWN/WHITE #914** and **RED #995** from the **Engine Section** to **Front Light Section**.
- **Tail Section:** The **Tail Section** will route through the interior of the car. Usually, the **TAIL SECTION** can remain in its current location in the harness, exiting the bottom of the fuse block. However, some installers also find it easier to route this section to exit the left side of the fuse block to make it easier to route under a door sill plate.
- **Dimmer Switch (1957 ONLY):** Locate the three wires that make up the **Dimmer Switch Section**. These wires are 14-gauge and colored **LT. GREEN, TAN,** and **YELLOW.** If you have a **1957** model, re-route these wires back through the firewall grommet and group them with the **WHITE #961 DRIVER SIDE DOOR JAM SWITCH** wire.
- **Turn Signal Switch:** If you are using an external/clamp-on style turn signal switch w/ an indicator light, you'll usually require a 3-pin flasher. This will allow the onboard indicator lights of the switch to function properly. To integrate a new, 3-pin flasher into the system you must bypass the 2-pin flasher of the Painless harness. The flashers do not come pre-installed on the fuse block but rather are found in your parts kit. Therefore, do not install the turn signal flasher. Then, on the wire side of the fuse block unpin the **YELLOW** wires leading to the flasher and splice them together. See [page 83](#).

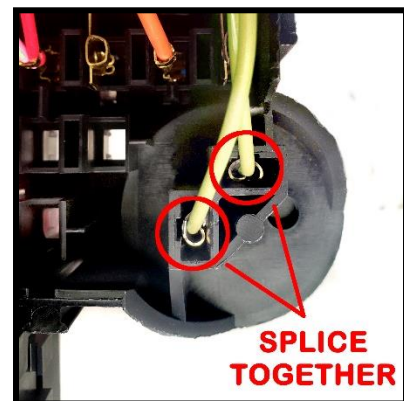

- **Ignition Switch**: If you have a **1957** model, they do not have a dedicated bulb in the ignition switch. Therefore, the **GREY #930** wire in the **Ignition Switch Section** can be either capped and stowed or used for other panel backlighting.
- **Hazard Switch**: Locate the **BROWN #951** wire in the **Turn Signal Switch Section**. If you are not using a hazard switch, this wire can be stowed away or removed completely along with the hazard flasher.
- **Electric Fuel Pump**: Locate the **RED #947** wire in the **Tail Section**. If you are not using an electric fuel pump this wire can be used to power another accessory requiring ignition switched power not exceeding 15 amps. If you do not need this wire, cap and stow it neatly.
- **Third Brake Light**: If you are not using a third brake light, the **ORANGE #950** wire in the **Tail Section** can be capped and stowed.
- **Radio**: Locate the **BLUE #999** wire. This wire provided power to an amplifier from the radio. This is a lay-in wire and can be removed if you are not using an amplifier.

Locate the group of wires on the harness with a section label reading “**SEE MANUAL PAGE 19.**” This group of wires contains the following sections: **Reverse Switch**, **Neutral Safety Switch**, and the **Accessory Section**. These sections and the individual wires of the **Accessory Section** may need to be re-routed from their current position in the harness. To re-route individual wires, removing the zip ties and the section label may be necessary

- **Reverse Switch**: Locate the **#956 LT. GREEN** & **#958 PINK** wires intended for reverse/back up lights. If you have a GM column-mounted reverse switch, a reverse switch on a floor-mounted shifter, or a transmission-mounted reverse switch that you plan to access through the transmission tunnel or floorboard, these wires can stay in their current location. If you have a transmission mounted reverse switch, and need to access the connection in the engine compartment, re-route the **#956 & #958** to **Engine Section**.
- **Neutral Safety Switch (NSS)**: This is a single wire (**PURPLE #919**) from the ignition switch that will be routed to the NSS and cut to length. The cut-off portion will then be used to connect the NSS to the starter solenoid. If you have a GM column-mounted NSS, a manual transmission with a clutch pedal switch, an NSS on a floor-mounted shifter, or a transmission-mounted NSS that you plan to access through the transmission tunnel or floorboard, the **PURPLE #919** wire can stay in its current location.

If you have a transmission-mounted NSS and need to access your connection in the engine compartment, re-route the **PURPLE #919** wire to the **Engine Section**. Be aware, once you have routed the wire to the NSS and cut it to length, the cut-off portion will need to be routed out into the engine compartment and to the starter solenoid.

- **Accessory Section:**

- **Wiper Motor/Switch:** The **YELLOW #905** wire is power for a wiper switch/motor. If your wiper switch switches power, route the **#905** wire with the **Headlight Switch Section**. If the motor is activated by ground from the wiper switch, route it with **Engine Section**. If you do not have an electrical wiper system, this wire can be used to power some other accessory so long as the max amperage does not exceed 10 amps.
  - **Cigarette Lighter/Power Port:** The **RED #903** wire provides a battery power source to a cigarette lighter/power port. If you are using the factory lighter/power port, this wire can be routed with the **HVAC Panel/Blower Switch** section.
  - **Accessories:** The **PINK #906** and **BLACK #969** wires provide a switched ignition power source for an accessory (**not exceeding 15 amps**) and a ground source respectively. Re-route the **PINK #906** and **BLACK #969** in the harness to wherever the accessory is located. Also, the **GREY #930** wire provides a backlighting source for any accessory and/or the gear indicator light. Re-route the **GREY #930** in the harness to wherever it is needed.
  - **Power Windows and Locks:** These features will have a separate harness that requires a power source. The **PINK #911** wire provides an ignition switched power source to the windows and the **ORANGE #910** wire provides constant power to the power locks. Route these wires toward their respective sub-harness / controller connections.
  - **Blower Motor:** If you have a blower motor that is mounted in the engine compartment, reroute the **BROWN #967** wire with the **Engine Section**. Also, aftermarket A/C systems have a separate harness that the wires of the Painless harness will connect to. Since these systems have their own harness, the **BROWN #967** wire will typically not be used and can be removed.
- Read through this manual with the harness laid out in front of you. Entire sections may need to be re-routed or separated due to the way or where the fuse block is to be mounted and how you want to route wires. Also, take note of wires you may not need and remove them from the harness. This will clean up the appearance of the install. **Painless does not recommend removing any power wires from the fuse block as they can be used to power other things.**

When bundling wires into groups, use zip-ties, split loom, or tape. The exposed wires in the engine compartment and wires running to the rear of the vehicle are best protected by wire loom or covering. *Painless offers the **Power Braid Kit part #70920** and the **Classic Braid #70970** to fill this need. These kits include everything you will need to properly protect your new chassis harness.*



**PowerBraid Kit**

## **FUSE BLOCK MOUNTING**

To begin mounting the fuse block, find a suitable location with easy access in the event that a fuse needs to be replaced. Most of the time, the vehicle's original fuse block location is ideal. This harness is designed with the intent of the fuse block being mounted on the driver's side of the vehicle and under the dash. **This fuse block must be mounted inside the vehicle** as it is not suitable for wet conditions.

- Locate the fuse block mounting bracket in your kit. This bracket offers several mounting options and can accommodate the factory mounting locations of all three Tri-Five years. The multiple mounting holes allow you to reuse the factory mounting positions or find a location that best suits your install.
- As factory mounting locations changed each year, see the directions below for your particular year model.



## FIREWALL PADDING

- There is thick padding mounted on the interior of the firewall that must be modified to seat the pass-thru grommet for the **Front Light Section**. The hole in the padding is not large enough to accommodate the grommet in this kit and will need to be enlarged to about  $2\frac{1}{8}$ ".
- Place masking tape around the hole. Then place the  $1\frac{1}{2}$ " **tape-on grommet** found in your parts kit in the hole. This grommet is the same as the one pre-installed on the harness.
- With the loose grommet in place, trace the outside diameter. Then, cut out the marked section of the firewall pad.
- With this hole cut, pass the **Front Light Section** through the hole and seat the grommet in the firewall.

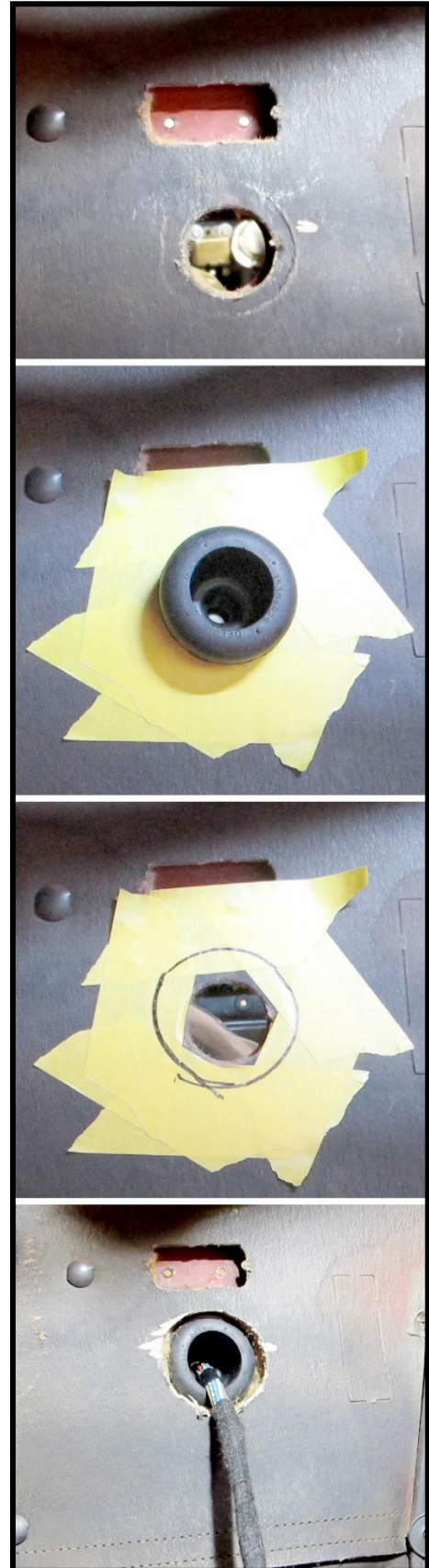

## 1955

- In 1955, the factory fuse block was mounted on the firewall right above the hole for the **Front Light Section**, as seen in the first image on the previous page.

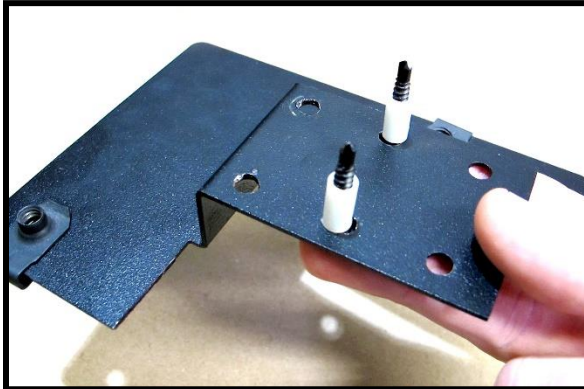

- Now, it is time to mount the fuse block mounting bracket. Locate the **(2) ½" nylon spacers** and **(2) #8 x 1" self-tapping screws** from the parts kit. Using the spacers will allow you to mount the bracket to the firewall without removing the firewall padding. If you do not have firewall padding, the spacers will not be needed.



- With the screws and spacers in place, mount the bracket to the firewall right above the firewall pass-thru for **the Front Light Section**.

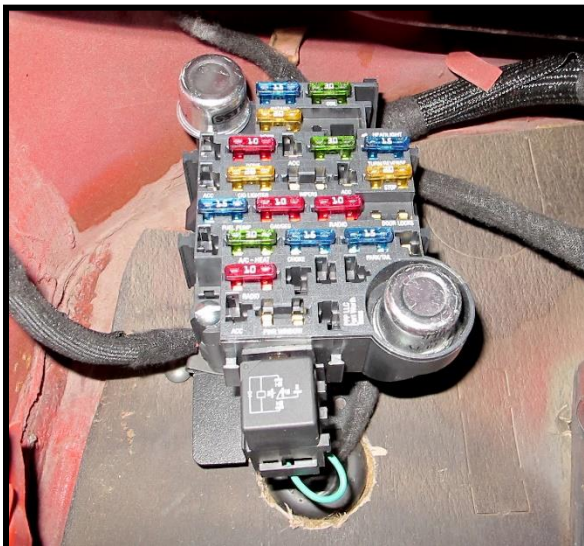

- Finally, locate the **(2) ¼"-20 x 2" mounting bolts** from the parts kit and mount the fuse block to the bracket using the attached u-nuts.
- Skip to **page 26** for harness routing.



## 1956

- The factory mounting position on the 1956 model was under the dash, above the firewall.



- Mount the bracket to the factory position using **(2) #8 x 1/2" self-tapping screws** from the parts kit. (Please note the bracket in the photo was a pre-production prototype, the one provided with your kit looks slightly different.)
  - Finally, locate the **(2) 1/4"-20 x 2" mounting bolts** from the parts kit and mount the fuse block to the bracket using the attached u-nuts.
  - Skip to **page 26** for harness routing.

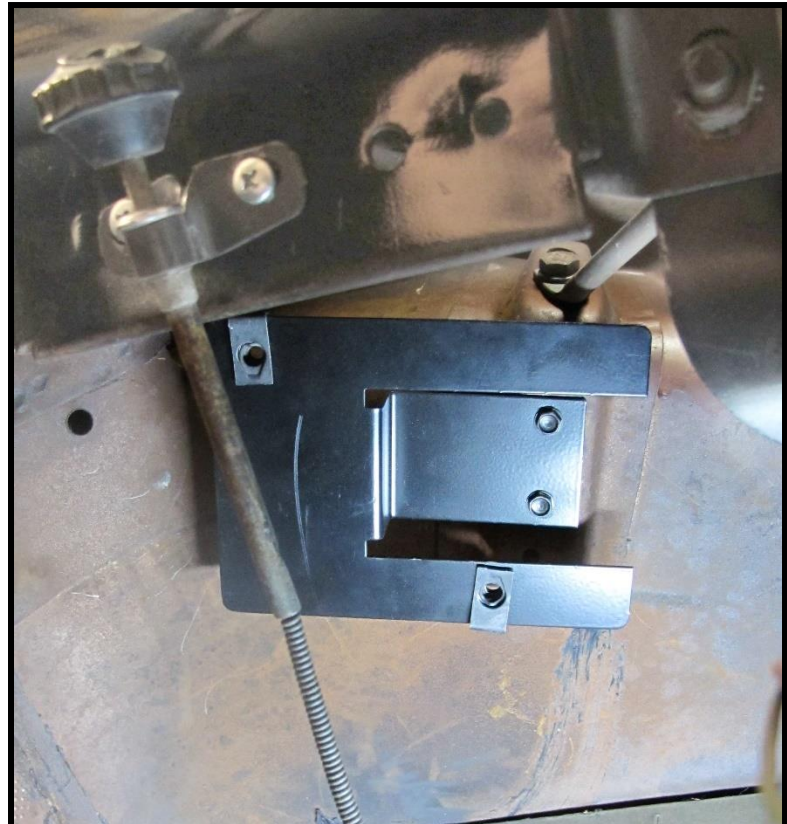

## 1957



- The factory mounting position on the 1957 model was on the driver's side kick panel.

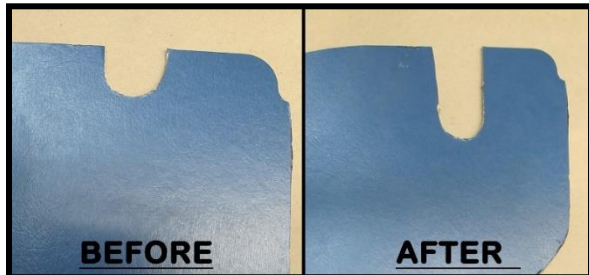

- The panel itself will need to be removed and modified to fit around the mounting bracket.

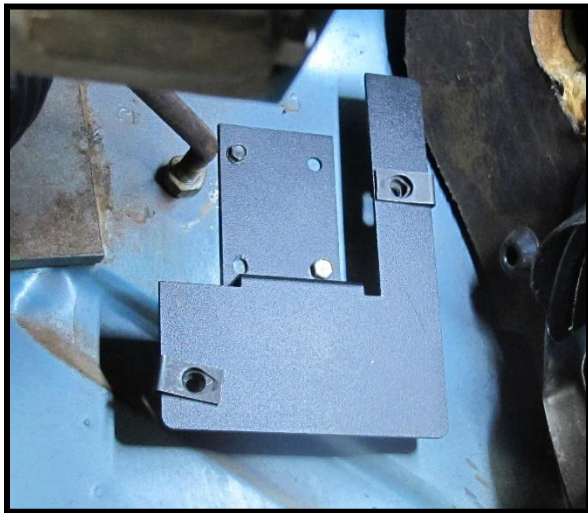

- Mount the bracket to the factory position using **(2) #8 x 1/2" self-tapping screws** from the parts kit. Only one of the factory holes will be used. The installer must use one of the other holes in the bracket to tap a new hole for secure mounting.

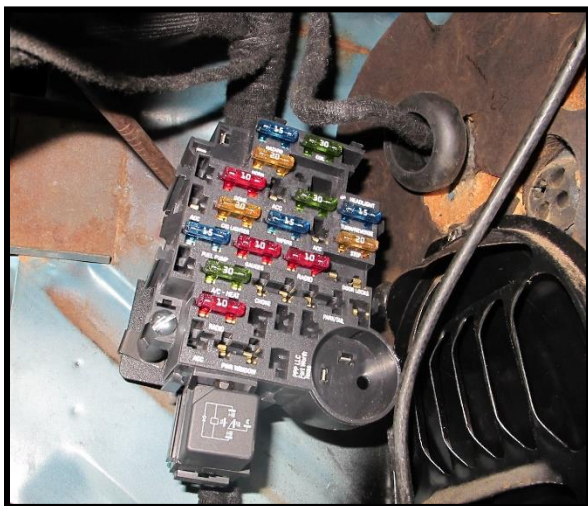

- Finally, locate the **(2) 1/4" - 20 x 2" mounting bolts** from the parts kit and mount the fuse block to the bracket using the attached u-nuts.

# HARNES ROUTING

Loosely route all of the wire groups to their designated connection points. **NO CONNECTIONS OR CUTTING WILL TAKE PLACE AT THIS TIME.** Harness routing is and should be a time-consuming task. Taking your time will enhance the appearance and quality of the installation. Please be patient and **TAKE YOUR TIME. REMEMBER TO ROUTE THE HARNESS AWAY FROM SHARP EDGES, EXHAUST PIPES, HOOD, TRUNK AND DOOR HINGES, ETC.**

**WHILE ROUTING WIRES: If you are to go through an inner fender well (as described on page 28), core support, or any other metal pass-through YOU MUST INSTALL A RUBBER GROMMET.**

Also, some wires will have the same 900-series number as they're on the same circuit. Always be sure to read the wire print as well to insure you are routing the correct wire.

## FRONT LIGHT SECTION

There are several options for routing the **Front Light Section**. Below we'll cover a few of these methods. All the parts included for this section are in a bag labeled "FRONT."

### Engine Compartment - 1955 & 1956

- Route the dimmer switch wires down through the hole below the firewall opening.
- The first method is to follow the factory routing down the inner driver side fender to the core support. Reuse the factory clips or the **Adel clamps** provided in the kit.
- From here, pass the driver-side wires through the core support (1) using a  $\frac{3}{4}$ " **grommet** from the parts kit.
  - The passenger-side wires can pass through as well if you plan to route them on the front side of the core support.
  - The horn wire can also pass though if your horn(s) are mounted in front of the core support.
  - The factory harness used a connector at the core support. This connector is no longer available. If you chose to re-use your connector, new terminals have been provided in the kit. See [page 5](#) for how to install factory-style terminals.
- Once on the front of the core support, there will be two holes in the fender (2 & 3) leading to the headlight and turn/park light. The headlight wires pass through the top hole (2) while the turn/park lights pass through the bottom hole (3). Both holes (2&3) require a  $\frac{3}{4}$ " **grommet** from the parts kit.



- For added protection, cover the wires between these points (1 → 2 & 1 → 3) with the **¼" PVC sleeve** provided.
- You can also pass both the headlight and turn/park wires through the top hole (2) using a **¾" grommet** and use a supplied **¾" cap plug** to plug the bottom hole (3).
- Route the headlight wires through the hole in the headlight bucket using a **¾" grommet** from the parts kit. Then, route the turn/park wires down toward the turn/park light.
- Route the passenger side wires across the core support. If you choose to go through the radiator supports on the back side of the core support, **½" holes** may need to be drilled in the support (see #6 in the photo below of a '57). **½" grommets** have been provided for this purpose. The passenger side wires will be routed just as you did on the driver's side.
- Route the **BLACK #924** horn and **GREY/WHITE #901** fan relay wires to their locations.

### Engine Compartment - 1957

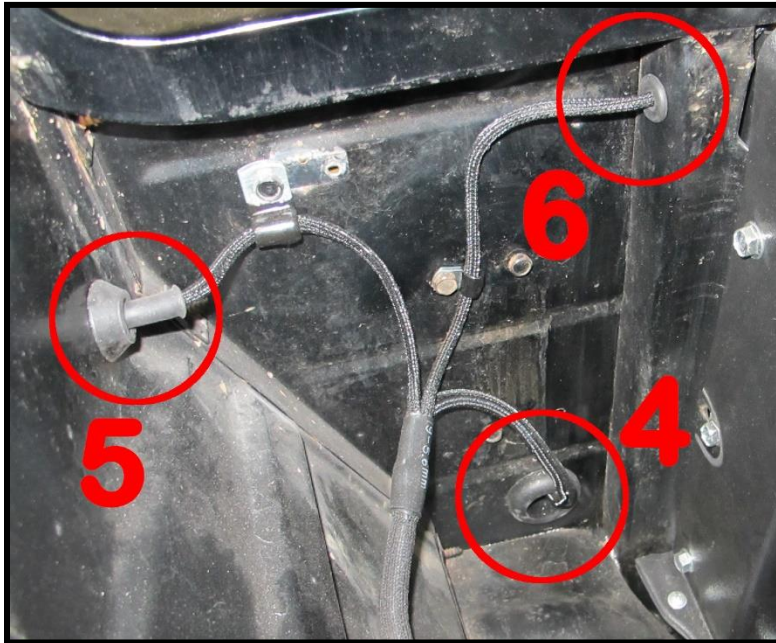

- Route the wires down the inner driver-side fender to the core support. From here, the turn/park and horn wires will pass through the core support (4) using a **1 ½" tape-on grommet** from the parts kit.

- Pass the headlight wires through the hole in the fender (5) near the backside of the core support using a **1" tape-on grommet** from the parts kit.

- Route the passenger side headlight wires across the core support. If you choose to go through the support, **½" holes**

may need to be drilled in the support (6). **½" grommets** have been provided for this purpose.

- Again, use a **1" tape-on grommet** to pass the passenger side headlight wires through the fender.
- Route the **BLACK #924** horn and **GREY/WHITE #901** fan relay wires to their locations.

## Wheel Well

- For a cleaner installation , you can route this section inside the fender and across the wheel well to help hide the wires.
  - Make a **1 ½” hole** in the back of the driver’s side wheel well. Then, use the **1 ½” tape-on grommet** from the parts kits to pass the front light wires from the engine compartment through to the wheel well. The **½” PVC sleeve** from the parts kit needs to be added to the harness before routing it across the wheel well.
- 
- Use the **Adel clamps** provided to secure the wires to the wheel well.
  - Use the **¾” cap plug** to plug holes in the fender (2 & 3) and core support (1) that you bypassed (see **page 26**).
  - Route the passenger side wires under the core support to the right side of the vehicle.
  - Route the **BLACK #924** horn and **GREY/WHITE #901** fan relay wires to their locations.

## ENGINE SECTION

- The **Engine Section** and **RED #916** will pass through the firewall using a separate hole just above the engine on the driver’s side.
- Use a **1” grommet** from the parts kit for the firewall pass-thru.
- Route the wires across the firewall. Routing of the individual wires will be easier to accomplish during the time of their specific connections.

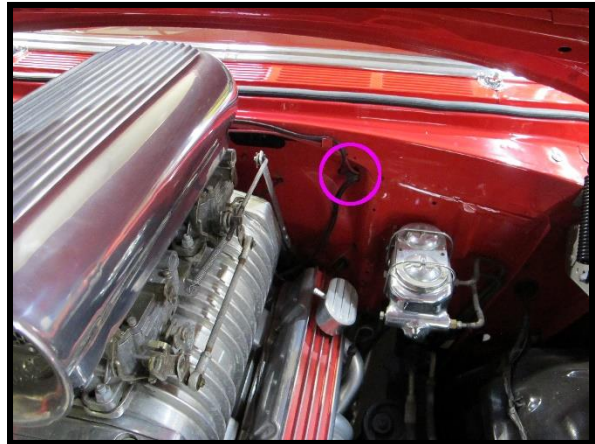

## ON THE INSIDE OF THE VEHICLE:

- Route the wires intended for dash-mounted components/switches towards their connection points on the dash at this time. Pay attention to the **Accessory Section** as this bundle contains wires that can/will be routed to different places.
- Route the **Tail Section** group of wires under the sill plate and through the interior of the vehicle to the rear.

## TAIL SECTION:

- At the back of the vehicle, route the taillight wires down the left side using the factory clips.

- Breakout the **ORANGE #971** and **WHITE #961** dome light wires near the wheel well and route them toward the dome light connector.

- Breakout the **BROWN #939** wire for fuel sending unit near the wheel well and route it toward the center of the vehicle. There is a passthrough in the trunkpan for the fuel wires that requires a  $\frac{1}{2}$ " **rubber grommet** from the parts kit. **NOTE:** This small grommet can be found in the same bag as the zip-ties and flashers.



- If you are using an electric fuel pump, the **RED #947** wire can be routed with the **BROWN #939** wire or the **BLACK #929** license plate light wire, depending on the pump's location. If you are using it to power an accessory, route it to the accessory location now.
- Route **BLUE #999** wire toward the amplifier at this time.
- The remainder of the parts needed are found in a bag labeled "TAIL."



- Near the rear bumper, there is a passthrough for the left reverse and taillight wires: **PINK #949**, **BLACK #929**, and **LT. GREEN #956**. Use a **1 1/2" tape-on grommet** from the parts kit to pass these wires through the trunk to the left taillight. The **BLACK #929** license plate wire can also passthrough if you wish to route it under the bumper and not through the trunk.

- Along the trunk pan, near the bumper, you will find one or two access holes for the license plate light(s). Route the **BLACK #929** license plate wire through the first hole using a **½” rubber grommet** from the parts kit.



- There is only one **BLACK #929** license plate wire. If you have two license plate lights you will have to double the wire at the first light and route the remainder of the wire to the second light. With the wire routed through the first grommet, make a large loop and pass most of the wire back through the grommet and into the trunk. From there, route the wire to the second license plate access hole. Again, use a **½” rubber grommet** from the parts kit. The loop you created will be cut later when the connection is made on [page 128](#), and both ends will attach to the first license plate light.
- Remember the **RED #947** wire can be routed with the license plate light wire if the electric fuel pump is mounted near the rear bumper.
- Route the remaining wires toward the passenger side. The taillight/reverse lightwires will passthrough the trunk like the driver’s side wires, using a **1 ½” tape-on grommet** from the parts kit.
- Once all the wires are routed and running to the general location of their components, you can begin making connections. We prefer to start with the **Front Light Section** and work from the front of the vehicle to the back.

# FRONT LIGHT SECTION

The Front Light Section of this Painless Harness includes all the power wires needed to properly hook up both driver and passenger side headlights and front turn signal/park lights. There is also a power wire from the fuse block mounted horn relay to power the horn(s) as well as a 12v power wire for a fan relay. All wires in the Front Light Section can be seen in the [Front Light Section Schematic](#) on [page 40](#).

Most of the hardware needed for this section can be found in the bag of the parts kit labeled "FRONT."

**If halogen bulbs are being used, a separate headlight relay kit MUST be used.**

Due to the higher amperage demands of halogen lights, these lights will cause the circuit breaker in the headlight switch to fail. A headlight relay harness provides battery power through the relays directly to the headlight bulbs. The headlight switch will activate the relays, thus drawing only 1 amp of current. This is beneficial for both the longevity of the headlight switch and the brightness of headlight bulbs themselves. Painless offers part [#30815](#) for single headlight vehicles.



## LEFT / DRIVER SIDE HEADLIGHT

Your first connection in Headlight Section will be the Left/Driver Side Headlight. Two wires are provided for connection to the Left Headlight, they are:

**LT. GREEN:** 14-gauge wire, **[FRONT LIGHT SECTION] #908 LEFT HIGH BEAM**; this wire provides power to the high beam filament of the headlamp. This wire runs from the dimmer switch and has power when the dimmer switch is in the high beam position and the headlight switch is in the headlight ON position.

**TAN:** 14-gauge wire, printed **[FRONT LIGHT SECTION] #909 LEFT LOW BEAM**; this wire provides power to the low beam filament of the headlamp. This wire runs from the dimmer switch and has power when the dimmer switch is in the low beam position and the headlight switch is in the headlight ON position.

**BLACK:** 14-gauge wire, printed **#969 HEADLIGHT GROUND**; this is a separate wire found in parts kit and provides a ground to the headlight.

The connection of these wires will depend on the style of headlights you are using in your application.



### 3 prong, Sealed Beam/Sealed Beam Halogen/H4 Halogen



Connectors & terminals (shown in the image below) have been provided in the parts kit to allow proper connection to these style headlights.

- Determine your grounding location for the headlight. Typically, this will be a bolt in the headlight bucket or a body bolt in the fender well.
- Starting from the grounding point, route the **#969** wire with the **#908** & **#909** wires, through the grommet in the headlight bucket if necessary.
- Cut the three wires to length and strip  $\frac{1}{4}$ " of insulation from them. Then, locate and install **59 series terminals** onto each wire. These terminals look like other terminals supplied in the parts kit; you will be using the larger, wider terminals as shown in the photo.

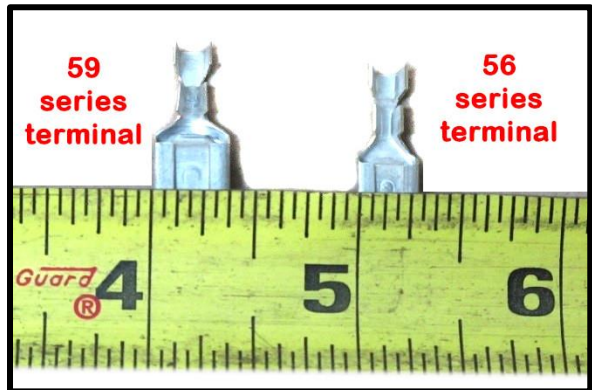

- Use the connector photo below for proper wire pinout. The connector is shown from the wire insertion side.

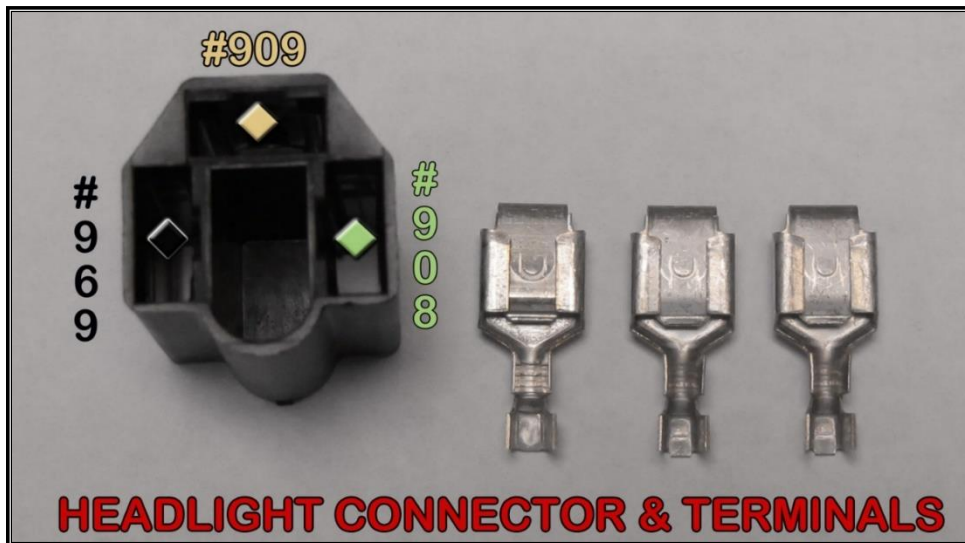

- After the pinout is complete, plug the connector onto the prongs of the headlamp. Make sure the connector is inserted straight onto the prongs as these prongs will easily bend making a proper connection difficult. Dielectric grease is recommended.
- There are **(3) 14-16 ga. #10 uninsulated ring terminals** and **heat shrink** in the “FRONT” bag of the parts kit. Strip  $\frac{1}{4}$ ” of insulation from the other end of the **#969 ground wire** and install a ring terminal and heat shrink. Then, ground this end of the wire to a suitable location.

### Headlights with Pigtails

To make the appropriate connections consult the manufactures instructions of the headlights you are using to identify each wire’s function. If you do not have instructions or know the manufacturer of the lights on your vehicle, you can test a light using your vehicle's battery.

On units that have 3 wires, in almost all cases there will be a black wire, this is typically a ground, while the other two, colored wires are the power for the high and low beams.

- Touch one of the colored wires to the positive side of the battery.
- With the colored wire touching the positive side, touch the **BLACK** wire to the negative side. You may see a couple of tiny sparks upon connecting to the negative side but this is normal. The light should now be on, take notice of how bright the light is.
- Remove both wires from the battery and repeat this process with the other colored wire. First to the positive side, and then the ground to the negative side.
- Whichever wire on the positive side of the battery made the light brighter is the high beam power wire or turn signal if your lamps have this option. Write this down in the notes section below for future reference.
- Cut the wires to length, taking the pigtail lengths into account, and connect them using the butt-splices and heat-shrink provided in the kit.

### Notes:

## LEFT TURN / PARK LIGHT

The Left Turn/Park Light of the Painless harness consists of 2 wires. These wires are:

**PURPLE:** 18-gauge wire, printed **[FRONT LIGHT SECTION] #927 LEFT PARK LIGHT**; this wire provides power to the park lights. This wire splices to a single **PURPLE** wire leading to the headlight switch. This wire has power anytime the headlight switch is in the Park/Tail Lights ON position.



**LT. BLUE:** 18-gauge wire, **[FRONT LIGHT SECTION] #926 LEFT FRONT TURN SIGNAL**; this wire is the turn signal power. This wire has interrupted switched power from the turn signal flasher any time the left turn signal is activated and the ignition is in the ON position. It also receives interrupted battery power from the hazard flasher any time the hazard switch is in the ON position.

### Hardwired – 1955 & 1956

Some vehicles will have turn signal wires hard wired to the light and exiting the turn signal assembly. To make this connection, remove the old terminals (if present) and replace it with the new 2-pin Weather Pack connector from the parts kit. See [page 6](#) for how to install and Weather Pack connector.

- Locate the following items from the parts kit:
  - (1) Weather Pack Male 2-pin connector**
  - (1) Weather Pack Female 2-pin connector**
  - (2) Weather Pack Male terminal**
  - (2) Weather Pack Female terminal**
  - (4) cable seals**

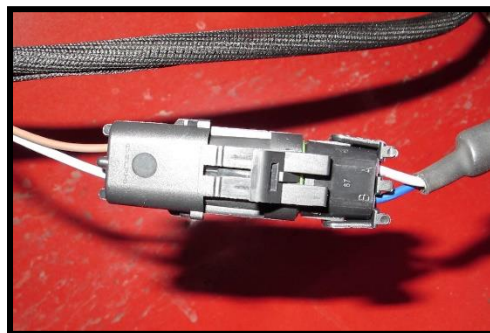

- Remove the old connector if present, slide the seals over the wires, and strip  $\frac{1}{4}$ " of insulation from the wires hardwired to the turn/park light.
- Install the terminals. Remember to crimp the terminal over the seal as seen on [page 6](#). Then, install the connector. Make sure to use the male connector if you used the female terminals and vice versa.
- Route the **PURPLE #927** and **LT. BLUE #926** wires to the newly installed connector and cut to length.
- Install the other terminals, seals, and connector to the **#926 & #927** wires just as you did in the previous steps. Make sure the wires are properly lined up before installing this connector. The **PURPLE #927** wire will connect to the factory **PURPLE** park lamp wire and the **LT. BLUE #926** will connect to the factory **BLUE** turn signal wire.
- Join both connectors together.

- The hardwired turn/park light socket grounds through the mounting of the lens/bucket. However, over time grounding issues may occur in which case a ground wire like the one seen to the right can be added.
- Source a piece of the **BLACK #969** Headlight Ground wire and a few ring terminals from the parts kit. Then, connect the back of the housing to a suitable ground.

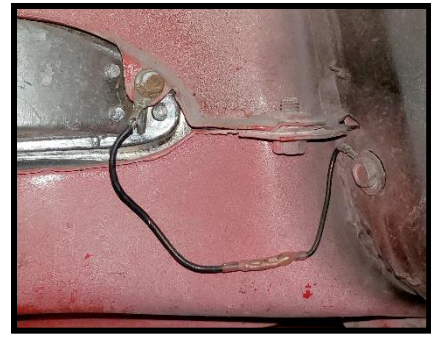

### New Socket – 1956 & Aftermarket

For those with a turn signal that requires a new light socket, (2) 3/4" **1157 socket assemblies** have been included in this kit.

- Before you connect to the socket take notice of the locking grooves on the side.
- With the longer locking groove facing you your turn signal wire will connect to the left contact and the park wire will connect to the right contact. \*NOTE: if you reverse these by mistake, remove the bulb and turn the spring assembly (2) around within the socket (3).

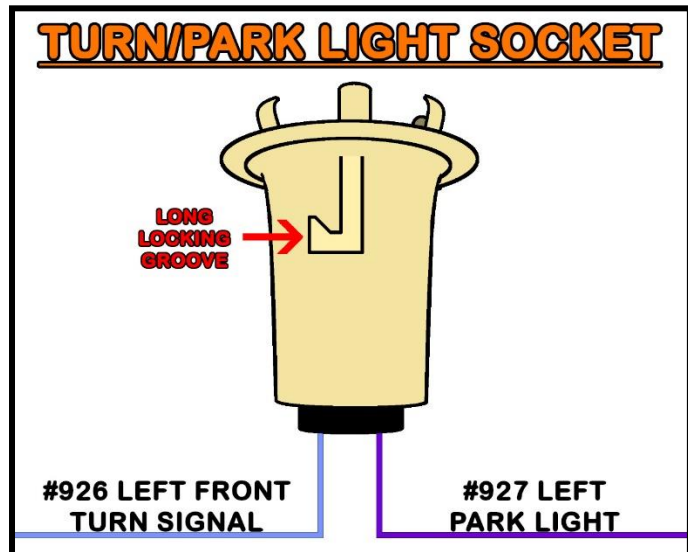

- Now, decide how you will connect the Painless harness wires to the turn/park light from one of the three options below.
- Plug the socket assembly into the back of the turn/park light housing temporarily to measure the **PURPLE #927** and **LT. BLUE #926** wires before cutting.



- Route the **PURPLE #927** and **LT. BLUE #926** wires to the socket; either to the pre-installed **BLACK** wires or the socket itself depending on how you make this connection (see options below).

- Connecting to the assembly can be done in one of three ways.

- I. There are (2) **BLACK** wires pre-installed that can be connected to using **butt-splices** and **heat shrink** from the parts kit.
  - a. Route the **PURPLE #927** and **LT. BLUE #926** wires to the **BLACK** socket wires and cut to length.

- b. Strip  $\frac{1}{4}$ " of insulation from the Painless harness wires and connect them to the **BLACK** socket wires using **butt-splices** and **heat shrink** from the parts kit.
  - II. Alternately, you may choose to connect to the assembly wires using the **Weather Pack connectors** as described in the previous section on hardwired turn/park lights ([page 34](#)).
  - III. For a cleaner install, remove the **BLACK** wires completely and install the harness wires directly into the socket using **new button contacts** (1) from the parts kit.
    - a. To do this unplug the socket from the back of the turn/park light assembly and remove the pre-installed **BLACK** wires. Slide the Painless harness wires through the socket (3) and spring assembly (2), strip  $\frac{1}{4}$ " of insulation from each wire, and install the **button contacts** (1) from the parts kit.
- With the **PURPLE #927** and **LT. BLUE #926** wires installed in the new socket, re-install the socket into the back of the turn/park light assembly if you unplugged it to make your connections.



### Grille Bar – 1957

On the 1957 model, the turn/park lights were located inside the grille bar. To make future maintenance easier, the Painless harness comes with a separate sub-harness for the grille bar. To properly install the turn/park light harness the grille bar will have to be removed.



- To remove the grille bar simply unbolt the ten nuts holding it to the grille and lift it off the center bar.
- Locate the following items from the parts kit

- A. (1) 1957 Front Turn Signal Harness
- B. (1) Weather Pack Male 3-pin connector
- C. (3) Weather Pack Female terminal
- D. (1) green cable seal
- E. (2) purple cable seals

- The turn signal harness has a female Weather Pack connector pre-installed. This then leads to two new contact assemblies and boots for the turn/park lights sockets. The longer side goes to the passenger side light.





- Connect the passenger side and slide the boot over the socket. Then, route the harness across the grille bar to the driver's side turn signal and connect it.
- Reattach the grille bar to the grille. The turn signal harness should be tucked neatly into the grille bar. Do not let it get accidentally pinched between the grille bar and grille.

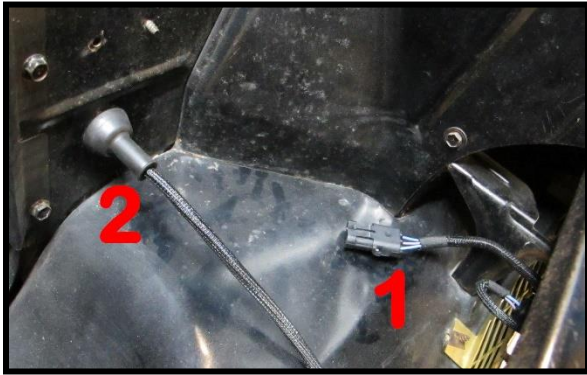

- On the driver's side you will see the pre-installed connector coming from the turn signal harness (1) and the four turn and park wires (2) of the main harness that were routed through the core support on [page 27](#). To make this connection install the 3-pin male Weather Pack connector to the main harness wires.



- Route the main harness wires to the turn/park sub-harness connector and cut to length.
- Strip  $\frac{1}{4}$ " of insulation from each of the main harness wires and slide the cable seals over the wires. Remember the double up the two **PURPLE** wires inside of the larger **GREEN** cable seal.

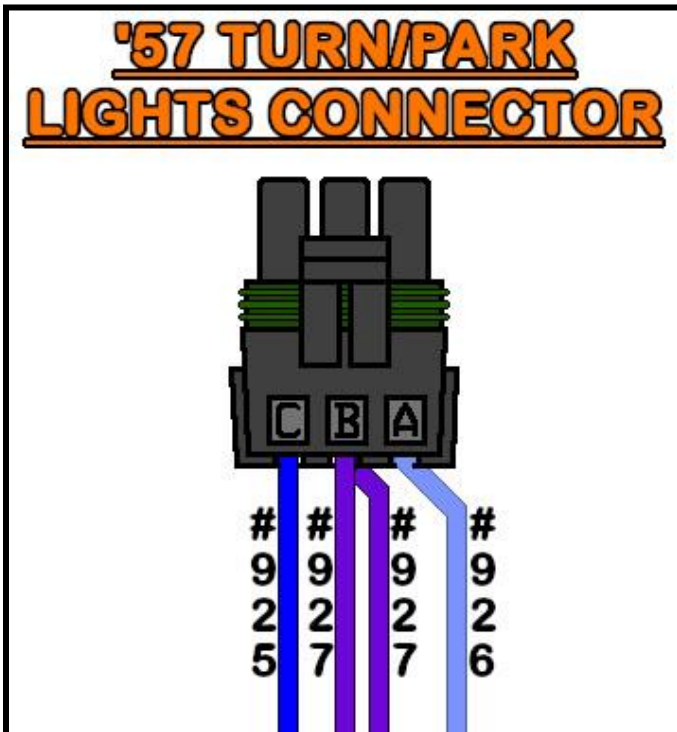

- Then install the wires into the Weather Pack connector as seen in the diagram to the right. For full details on how to install a Weather Pack connector see [page 6](#).

- A. **LT. BLUE #926**
- B. **(2) PURPLE #927**
- C. **BLUE #925**

- Connect the turn/park lights harness to the main harness.

## HORN

The **Front Light Section** has a single wire dedicated for connection to a horn. Most horns ground through their mounting and only require a power connection. This wire is:

**BLACK:** 14-gauge wire, printed **[FRONT LIGHT SECTION] #924 HORN**; this is a power wire that comes from the fuse block mounted horn relay. It is ground activated by the horn button on the steering column, and only has power when the horn button is pressed.

- Route the **#924** wire to the horn and cut it to length. If you pass this wire through any metal surfaces, you will find small grommets in the parts kit to protect the wire. If you have two horns, save the cutoff portion of **#924**.
- If you have a tab on the horn, **single-pin 56 series connectors** and **14-16ga. terminals** have been provided in the parts kit.

**#10 ring terminals** have been provided for those with “screw” or “post & nut” connections. If your horn has a wire to connect to, then a splice from the parts kit will work for this connection

- Strip  $\frac{1}{4}$ ” of insulation from the **#924** wire and crimp the appropriate terminal onto the wire. If you have more than one horn, strip  $\frac{1}{4}$ ” wire from the cutoff piece of **#924** and double the cutoff piece of **#924** to the **#924** coming from the relay. Doubling up the wire will require a **10-gauge terminal** from the parts kit. If you are doubling up a 10ga. ring terminal, it will need to be supplied by the installer.
- If your horn requires a ground wire, it will need to be provided by the installer.

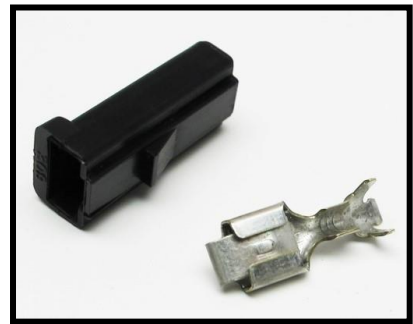

## ACCESSORY / FAN RELAY

While this Painless harness does not include any high amperage wiring specifically for a fan relay. There is a **GREY/WHITE #901** wire in the **Front Light Section** that can be used for a 12v activation.

**GREY/WHITE:** 18-gauge wire, printed **[FRONT LIGHT SECTION] #901 RELAY ACTIVATION (IGN POWER)**; this wire comes from the 15-amp CHOKE fuse. This wire has power anytime the ignition switch is in the ON and START positions. This wire can be used for the activation of the relay coil only and **MUST NOT** be used to directly power a cooling fan.

The remaining relay wiring, circuit breaker, relay, and temperature switches seen in the diagram are **NOT** included in this kit. Painless does offer numerous relay kits that do include these parts, like **Painless #'s 30101, 30102, or 30103.**

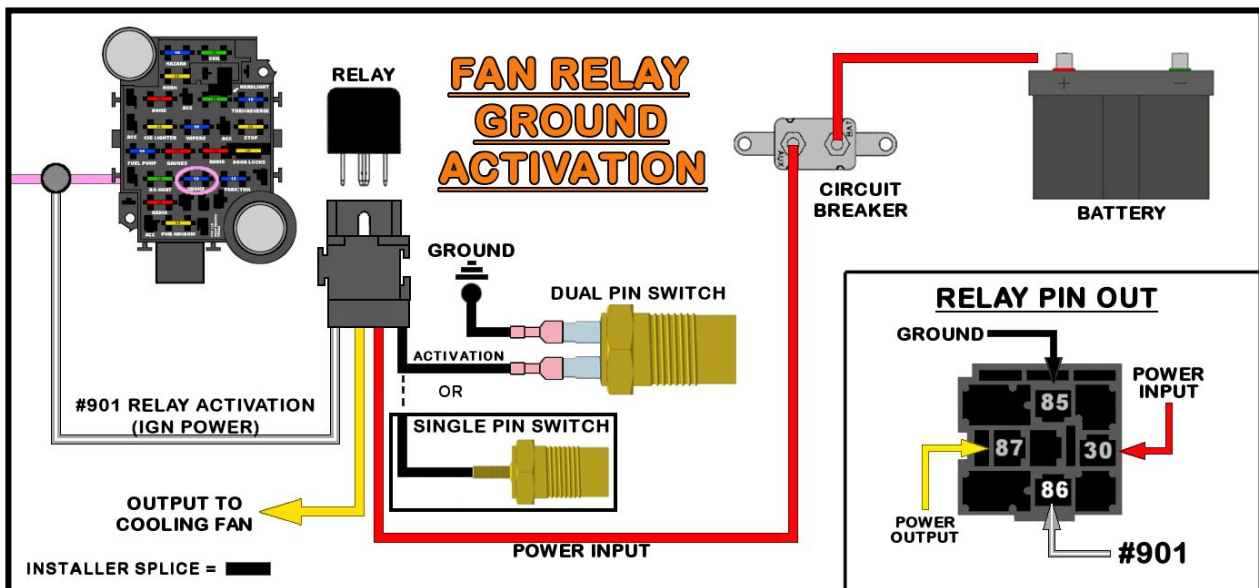
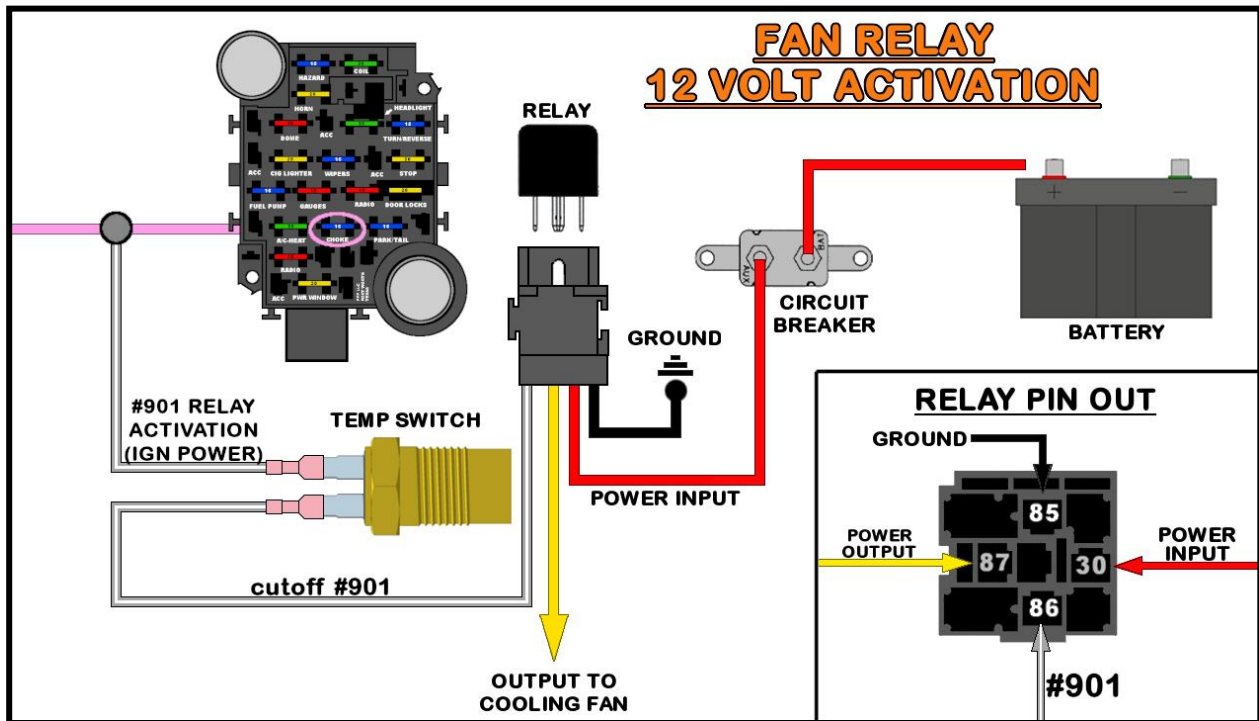



# RIGHT TURN / PARK LIGHT & HEADLIGHT

The connections on the right/passenger side of the vehicle all connect in the same manner as those on the left/driver's side. The only difference you will find is the turn signal wire for the right turn signal is a different color than the one used for the left turn signal. The right turn signal will be:

**BLUE:** 18-gauge wire, printed [FRONT LIGHT SECTION] #925 RIGHT FRONT TURN SIGNAL; this wire is the turn signal power and goes to the turn signal switch. This wire has interrupted switched power from the turn signal flasher any time the right turn signal is activated and the ignition is in the ON position. It also receives interrupted battery power from the hazard flasher any time the hazard switch is in the ON position.

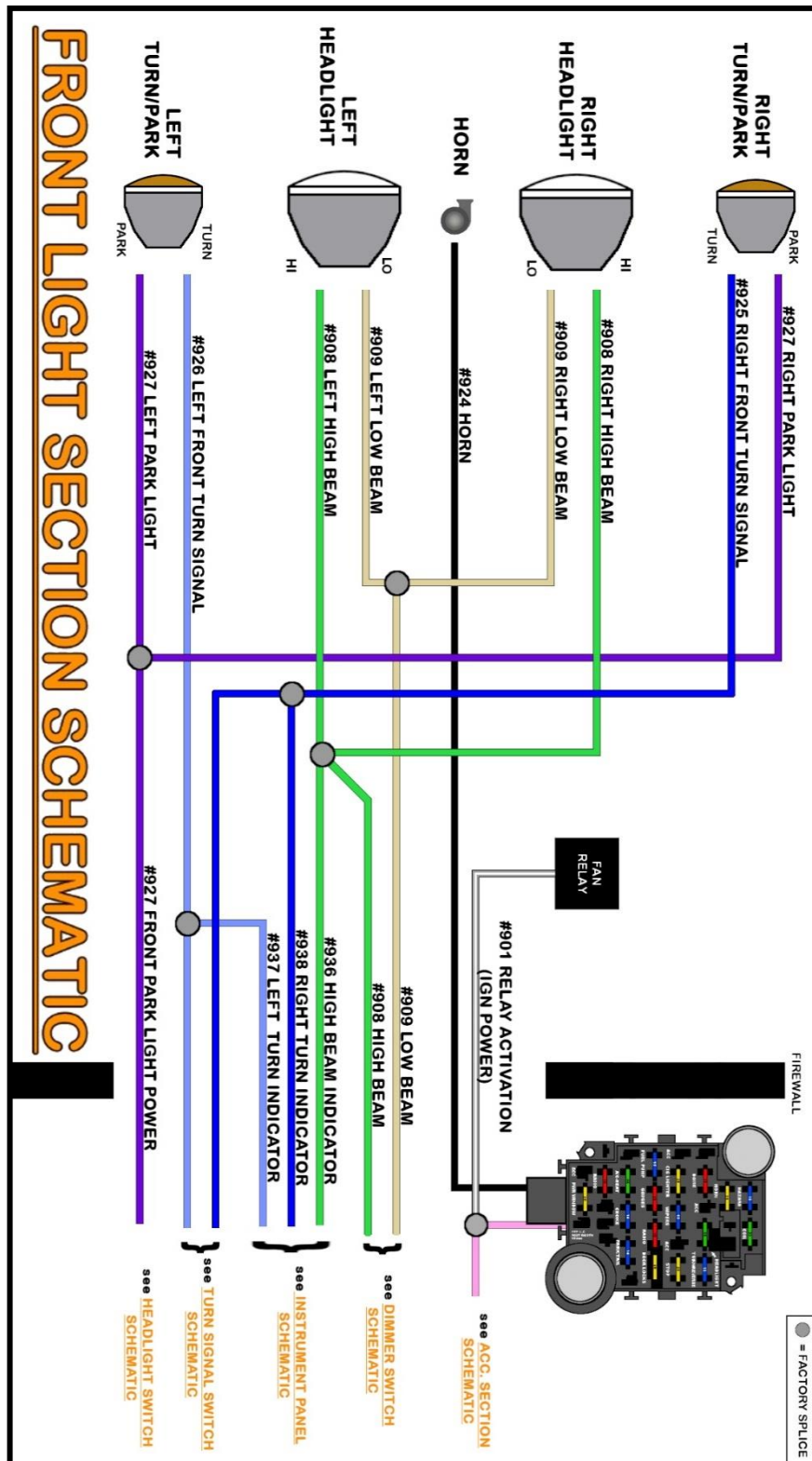

## ENGINE SECTION

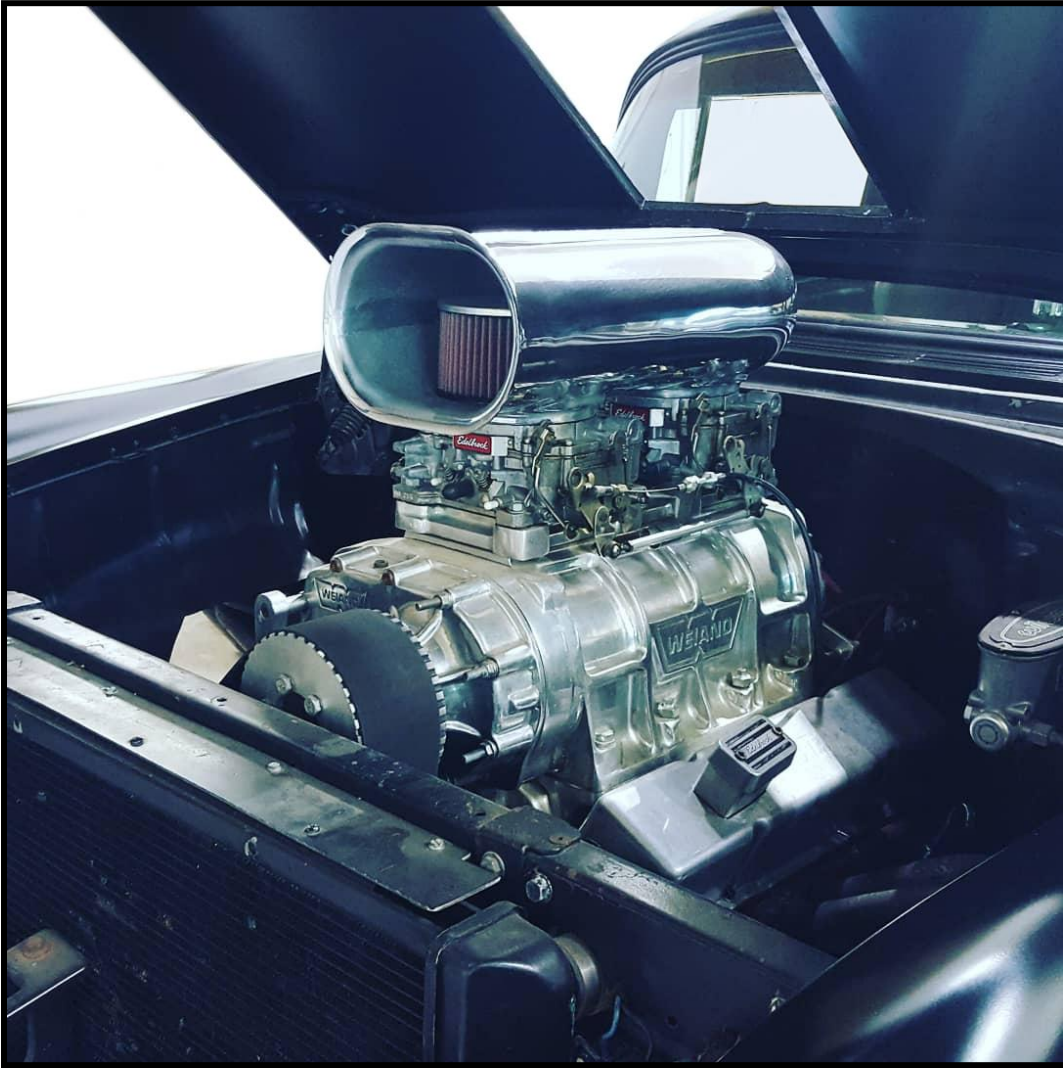

**Engine Section** consists of seven wires, some of which may or may not have already been re-routed to other places in the vehicle. These wires connect to the oil pressure and coolant temperature sending units for gauges or lights, the coil or ignition system, and an electric choke on a carburetor. There are also wires for the alternator that are covered in the **Start/Charge Section** on [page 52](#).

All wires of the **Engine Section** have ample length to account for the numerous ways components can be mounted inside an engine compartment. For example, an ignition box mounted on the inner fender requires more length of wire than a firewall mounted coil.

\*FOR THOSE WITH IGNITION CONTROL BOXES, THESE WIRES WILL CONNECT TO THE IGNITION BOX AND NOT THE COIL

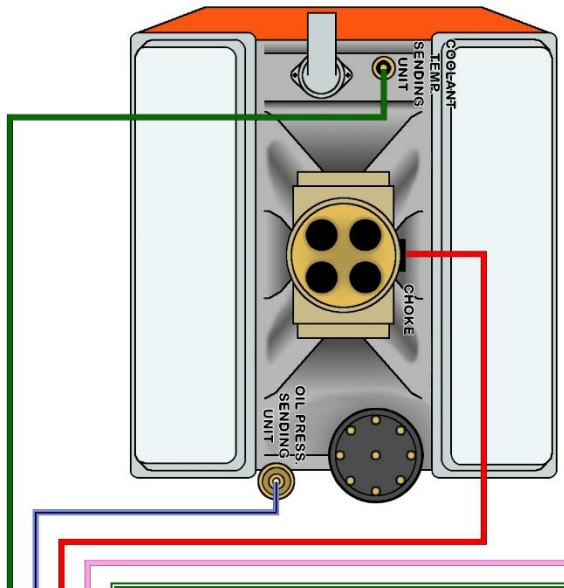

**FIRE WALL**

- #923 TACHOMETER SIGNAL
- #920 COIL (IGN PWR)
- #954 ELECTRIC CHOKE (IGN PWR)
- #922 OIL PRESSURE SIGNAL
- #921 COOLANT TEMP SENSOR

# ENGINE SECTION SCHEMATIC

see INSTRUMENT PANEL SCHEMATIC

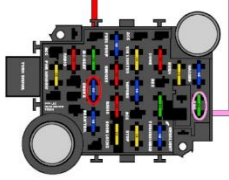

## COOLANT TEMP SENSOR

**GREEN:** 18-gauge wire, printed [ENGINE SECTION] #921 COOLANT TEMP SIGNAL [INSTRUMENT PANEL]; this wire sends a resistive ground signal to the engine coolant temp gauge. If you are using an aftermarket mechanical gauge, this wire is not needed. See the [Engine Section Schematic](#) on the previous page.



The coolant temp sending unit or temp switch can be mounted in the intake manifold or the side of either cylinder head. These will have a peg, tab, or threaded post to connect to, as seen in the photos on this page. Connectors and terminals have been provided for those with the style of sensors seen on this page.



Also, if connecting to an engine in a vehicle that has electric cooling fans, make certain you know the difference between the coolant temp sensor and the electric fan thermostatic switch; both of these sensors can look identical.

If you are installing a new temp sensor, or are unsure of the temp sensor currently mounted in your engine, make sure there is no sealant tape on the sensor threads. The tape can interfere with the ground source the sensor needs to read correctly. Anti-seize works well on the threads.

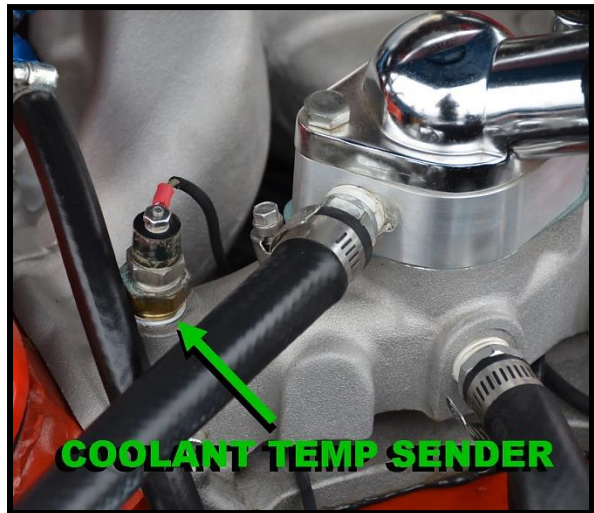

- Route this **GREEN #921** wire to the coolant temp sensor, cut to length, strip  $\frac{1}{4}$ " insulation, and crimp on the appropriate terminal for your connection, and connect.

## OIL PRESSURE SENSOR

**LT. BLUE/BLACK:** 18-gauge wire, printed **[ENGINE SECTION] #922 OIL PRESSURE SIGNAL [INSTRUMENT PANEL]**; this wire sends a ground signal to the oil pressure gauge. If you are using an aftermarket mechanical pressure gauge, this wire is not needed. See the [Engine Section Schematic](#) on [page 42](#).



The oil pressure sending unit will generally be located near the oil filter or on the back of the block behind the intake manifold.

- Route this **LT. BLUE/BLACK #922** wire to the oil pressure sending unit, cut to length, strip  $\frac{1}{4}$ " insulation, and crimp on the appropriate terminal for your connection, and connect.

Notched connectors & terminals have been provided for those with the style of sensor seen here. Rollover crimpers will be needed to properly install this terminal.

If you have a 2-wire sensor on a newer, fuel-injected, donor engine, it will not work for your pressure gauge. Two-wire sensors on fuel-injected engines are for fuel pump control and are not designed for oil pressure gauge readings. These types of sensors are generally found on GM TBI and TPI engines.

## **ELECTRIC CHOKE**

**RED:** 18-gauge wire, printed [ENGINE SECTION] #954 **ELECTRIC CHOKE (IGN PWR)**; this wire provides a switched ignition power source to the choke from the 15-amp CHOKE fuse. It has power when the ignition switch is in the ON/RUN position.

When you turn your key to the "ON/RUN" position, the voltage this wire carries heats the bi-metal spring called the "choke thermostat." This spring will unravel as it is heated causing the choke to slowly open. When the ignition is turned to the "OFF" position, power is no longer on this wire, causing the spring to begin to cool and contract, closing the choke.

- Route the **RED #954** wire to the + terminal of the electric choke and cut to length.
- Strip  $\frac{1}{4}$ " of insulation, install the supplied terminal and connector, and connect. **If you are using a Turbo 400 transmission, and a throttle switch is in the engine compartment, see the instructions below before terminating the #954 wire.**
- Double up the cut-off piece of **#954** at the choke to provide power to the Turbo 400 kickdown throttle switch.
- Ensure the choke is properly grounded (the ground wire is not supplied in the Painless harness) before continuing with the installation. This is normally provided with the carburetor.

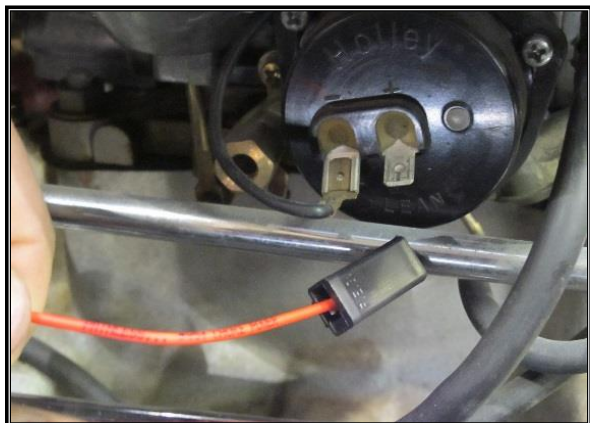
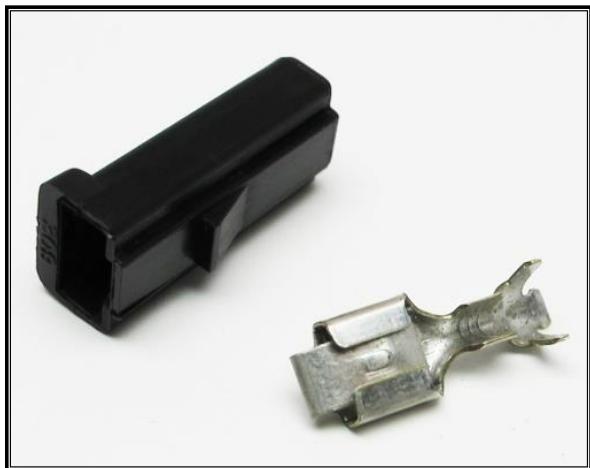

If you do not have an electric choke, you do not need this wire and it can be capped off and stowed. **If you are using a Turbo 400 transmission, see the instructions on the next page before terminating the #954 wire.**

## Turbo 400 Transmission

The Turbo 400 transmission requires a 12v power source to downshift the transmission under wide-open throttle. This is done through the use of a throttle switch either located on the accelerator pedal inside the vehicle or on the throttle linkage on top of the engine.

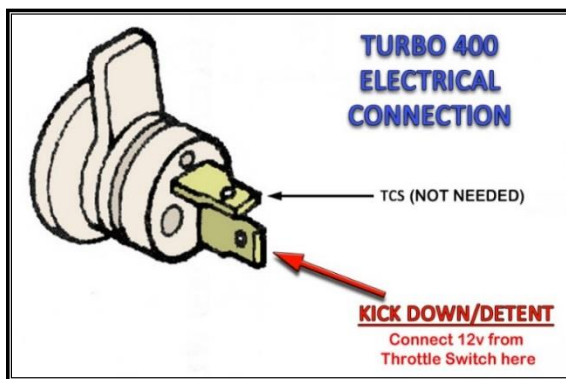

- Double up the cut-off piece of **#954** at the choke. This will require a **10ga. 56 series terminal** from the parts kit.
- Route this cutoff piece of **#954** to one side of the throttle switch and cut to length. Use terminals from the parts kit to connect the wire.
- If you have a factory, accelerator pedal mounted switch, you can use a switched power source inside the vehicle or you can route the cutoff piece of **#954** to the interior, connect at the throttle switch, and then route it back out to the transmission.

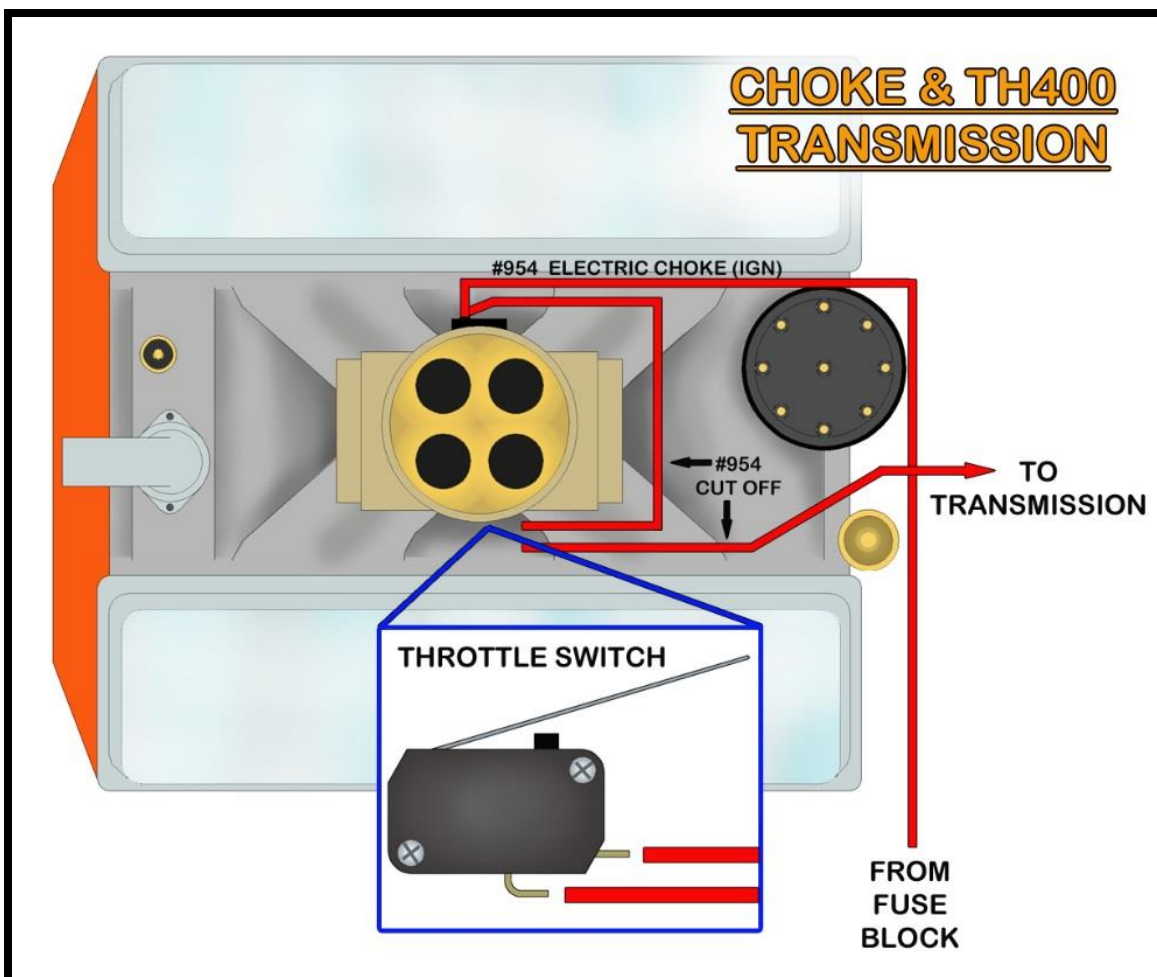

## COIL

A single wire, coming from the fuse block, supplies power to the coil/ignition system. The connection of this wire varies depending on what ignition system (factory or aftermarket) you use. The wire needed to supply a switched ignition power source is:

**PINK:** 16-gauge wire, printed **[ENGINE SECTION] #920 COIL (IGN PWR)**; this wire comes from the 30-amp COIL fuse. This wire has power anytime the ignition switch is in the ON and START positions. This wire provides the coil/ignition system with switched power in 1 of 4 ways:

- If the Coil you are using is not internally resisted, a ballast resistor, along with the installer-provided bypass wire shown on [page 49](#), will be required. If a coil is not internally resisted and a ballast resistor is not used, the coil will overheat within a few minutes to the point that it will no longer work. A ballast resistor can be obtained at your local parts store using part number **RU11**. See the [Ballast Resistor Connection Diagram](#) on [page 49](#).
- HEI coils, internally resisted coils, and most aftermarket ignition boxes do not require the use of a ballast resistor. The **#920** wire connects directly to the + side of the coil. See the [Coil Connection \(NO Ballast Resistor\) Diagram](#) on [page 49](#).
- If you use an aftermarket ignition box, such as an MSD, Accel, etc., this **PINK #920** wire will supply the ignition box with the switched power source it requires. This wire goes to the aftermarket ignition box and not the Coil; the ignition box will provide the Coil + connection. This **#920** wire may need to be pulled from the **Engine Section** and routed to where the box is mounted. See the ignition box manufacturer's instructions for a specific connection point of this power source.
- If you have converted to fuel injection, are using a standalone harness, such as a Painless fuel injection harness, and coil power is supplied through the fuel injection harness, in LT1/LS1 and newer applications, this **PINK #920** wire provides the fuel injection harness with the switched power source the harness requires. If you use a Painless fuel injection harness, this **PINK #920** wire will connect to the open-ended **PINK** wire of the fuel injection harness labeled "IGN" or "Fuse Block IGN."

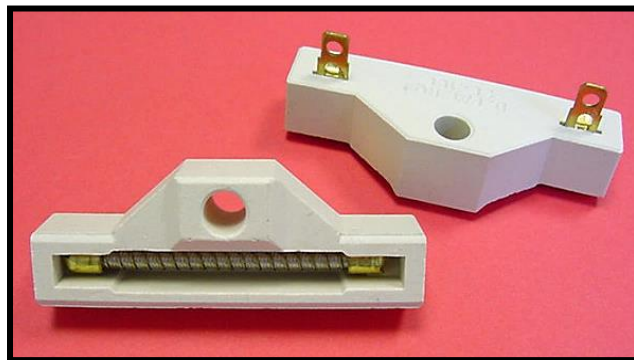

- Route this **PINK #920** wire to its proper connection point and cut to length, install the appropriate terminal for your connection, and connect.

Terminals and a factory-style connector, seen in the photo to the left, have been supplied to allow connecting to the + side of an HEI Coil.



## Tachometer

**GREEN/WHITE:** 18-gauge wire, printed **[ENGINE SECTION] #923 TACHOMETER SIGNAL [INSTRUMENT PANEL]**; this wire sends a tachometer signal from the coil to the gauge cluster. This wire only needs to be connected if you are using a tachometer (factory or aftermarket). See the [Engine Section Schematic](#) on [page 42](#). If you do not have a tachometer, this wire may be removed from the harness. Depending on your ignition system (factory or aftermarket), or use of fuel injection, the connection of this **#923** wire can vary:

- Standard factory type installs with an HEI distributor, or external coil ignition systems, require the **#923** wire to be connected to the negative (-) side of the coil. Refer to the diagrams on [pages 49 – 50](#) for proper connection.

Terminals and a factory-style connector are supplied to allow connecting to the (-) side of an HEI Coil (seen in the photo at right). Rollover crimpers are needed to install this terminal. Insulated terminals in the parts kit are supplied to make other connections.

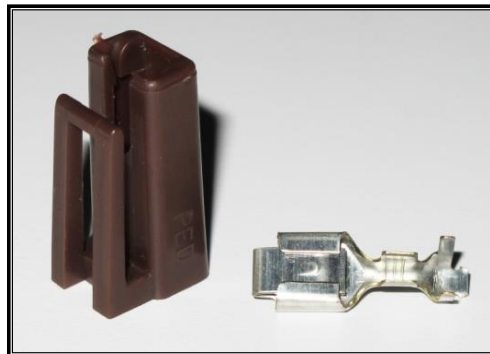

- If you are running fuel injection and the tach output wire of the fuel injection harness does not reach the tachometer, this **#923** wire will connect to the tach output wire from the ECM.
- If an aftermarket ignition box is being used, such as an MSD, Accel, etc., this **#923** wire will connect to the tach output found on the ignition box. Refer to the [MSD Ignition Connection](#) on [page 50](#) and the ignition manufacturer's installation procedure.
- Route this **#923** tach signal wire to its proper connection point and cut to length, install the appropriate terminal for your connection, and connect.

Use one of the following four diagrams to properly connect the coil power (#920) and tachometer (#923). **Not shown in the diagrams are the wire(s) connecting the coil and the distributor**, these are not included.

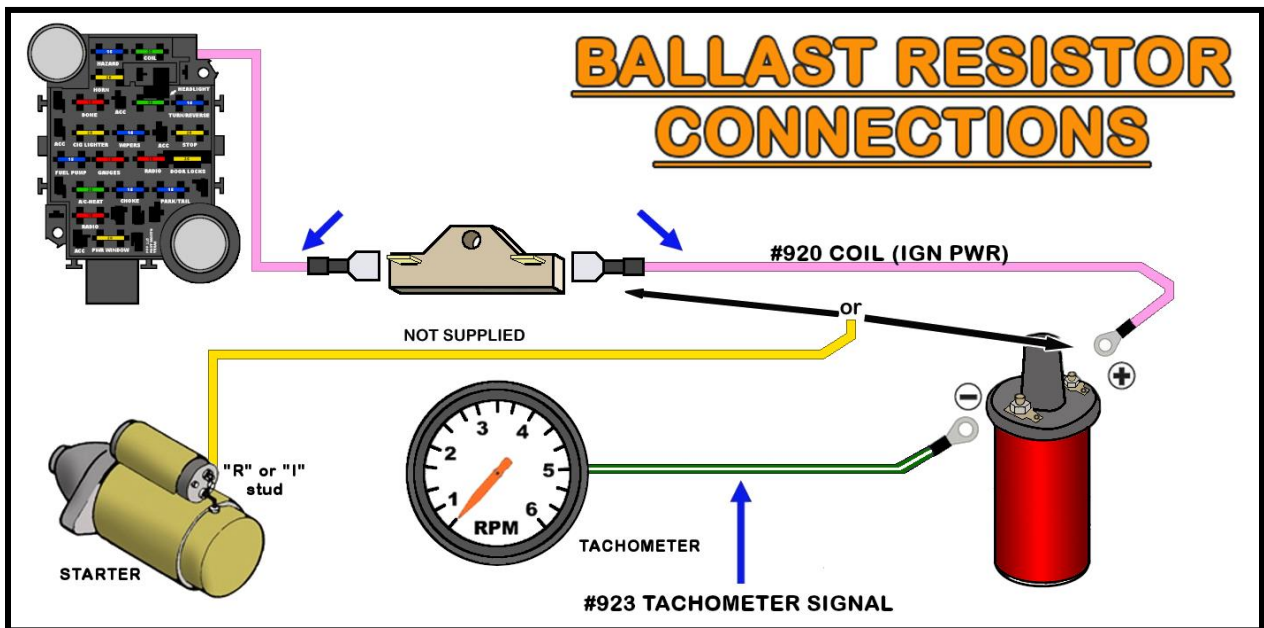
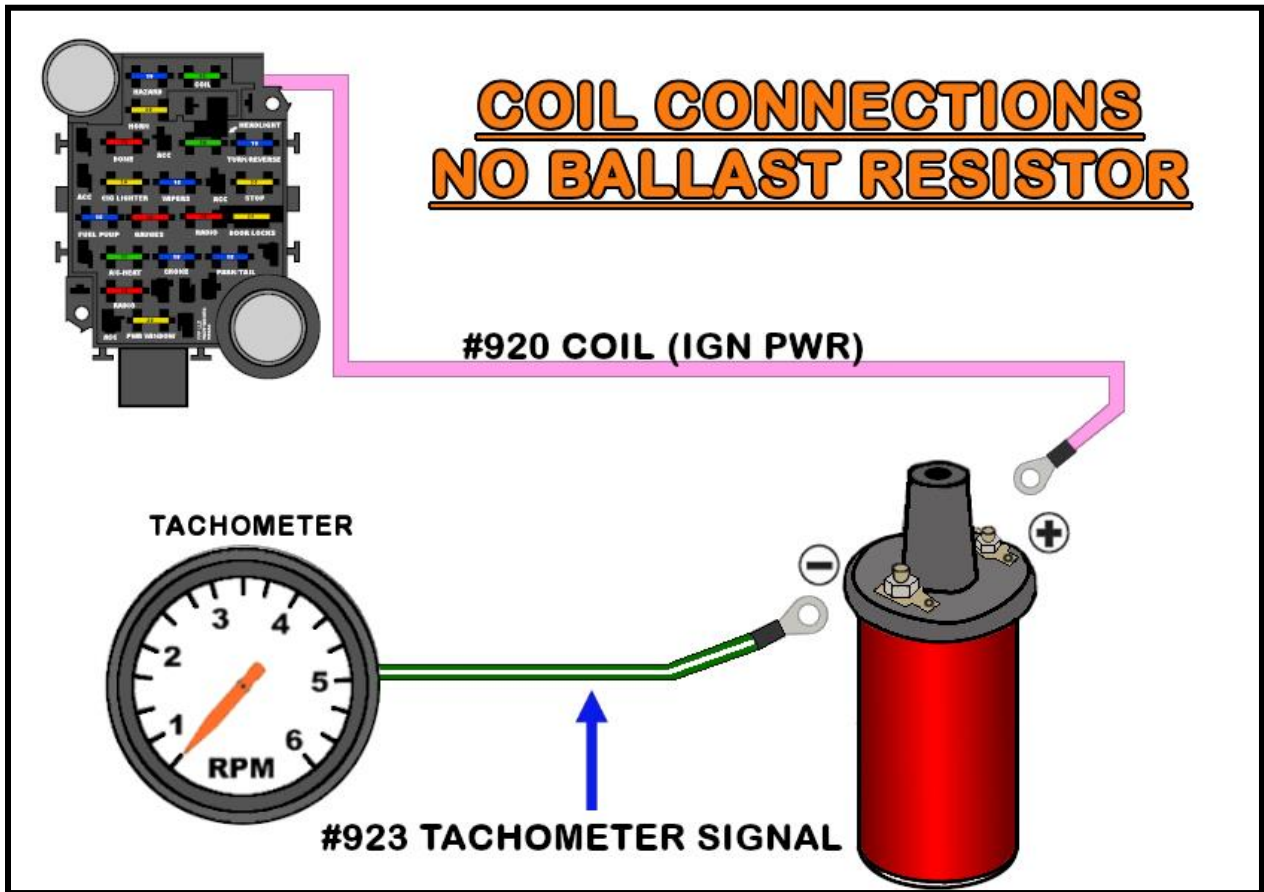

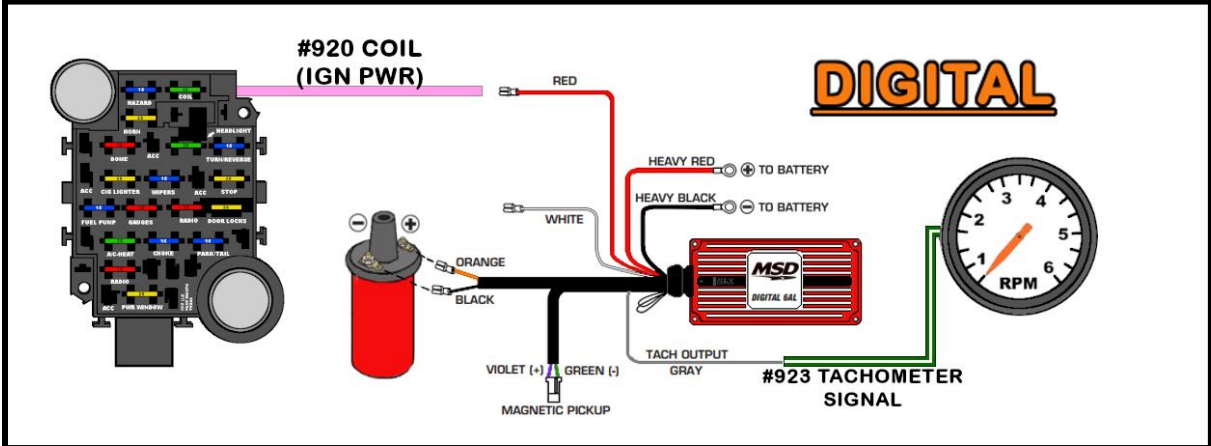
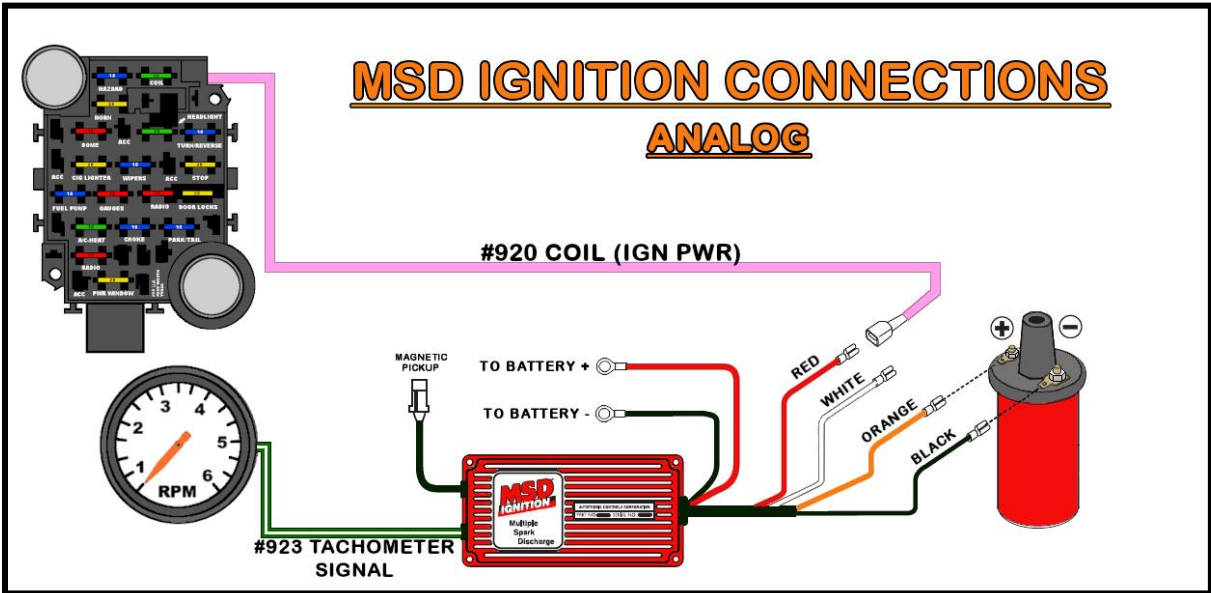
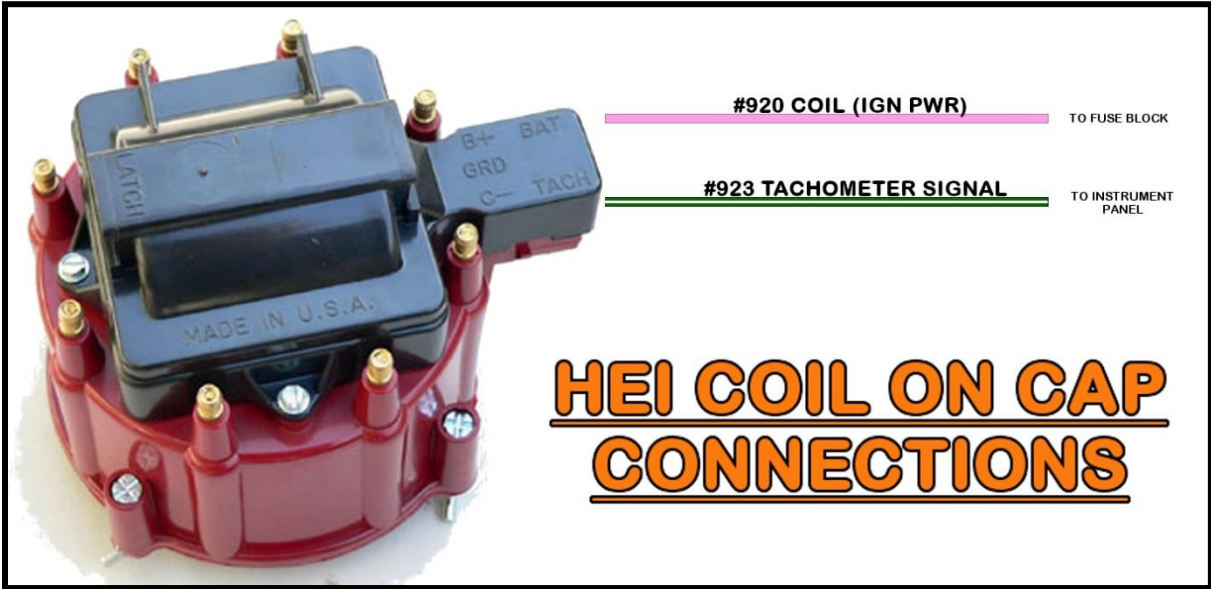

## **WIPER MOTOR**

Factory electrical wiper motors (as well as popular aftermarket versions) are power activated by the wiper switch. If this is the type of motor you are using, then skip this section as power will be routed directly to the wiper switch on [page 19](#). However, if you have converted to a wiper motor that is ground activated from the switch, the **YELLOW #905** wire should have been rerouted to the [Engine Section](#) on [page 41](#). The wiper motor connection will require a factory schematic or referring to the old harness.

Also please note, this harness does not include any additional wires for vehicles with wipers due to most aftermarket wiper assemblies having separate harness/wires. If you do not have an electrical wiper system, this wire can be used to power some other accessory so long as the max amperage does not exceed 10 amps, or it can be capped and stowed away.

**YELLOW:** 16-gauge wire, printed **[ACC. SECTION] #905 WIPER SWITCH POWER (IGN)**, this wire supplies switched ignition power to the wiper motor from the 15-amp WIPER fuse on the fuse block.

- Route the **YELLOW #905** wire to the wiper motor, cut the wires to length, and attach the provided terminals and connectors.
- Connect the **YELLOW #905** wire to the power tab of the wiper motor. Remember to consult the factory schematic for the wiper motor or your old harness.

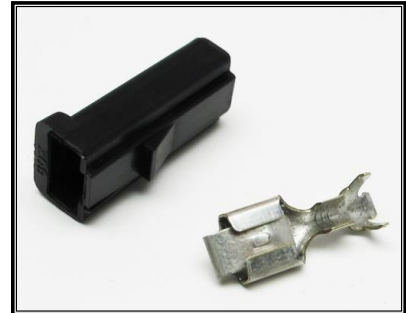

# START/CHARGE SECTION

The **Engine Section** contains two wires for the alternator regulator connections. These regulator wires along with the MIDI fuse wire, the starter solenoid wire, and the 6-gauge alternator output wire make up the **Start/Charge Section**. Locations of all of these components vary from vehicle to vehicle so no specific routing instructions can be given. Most of the hardware required for this section can be found in the "ALTERNATOR" bag kit. This inline fuse provides a fused link between the alternator and battery.

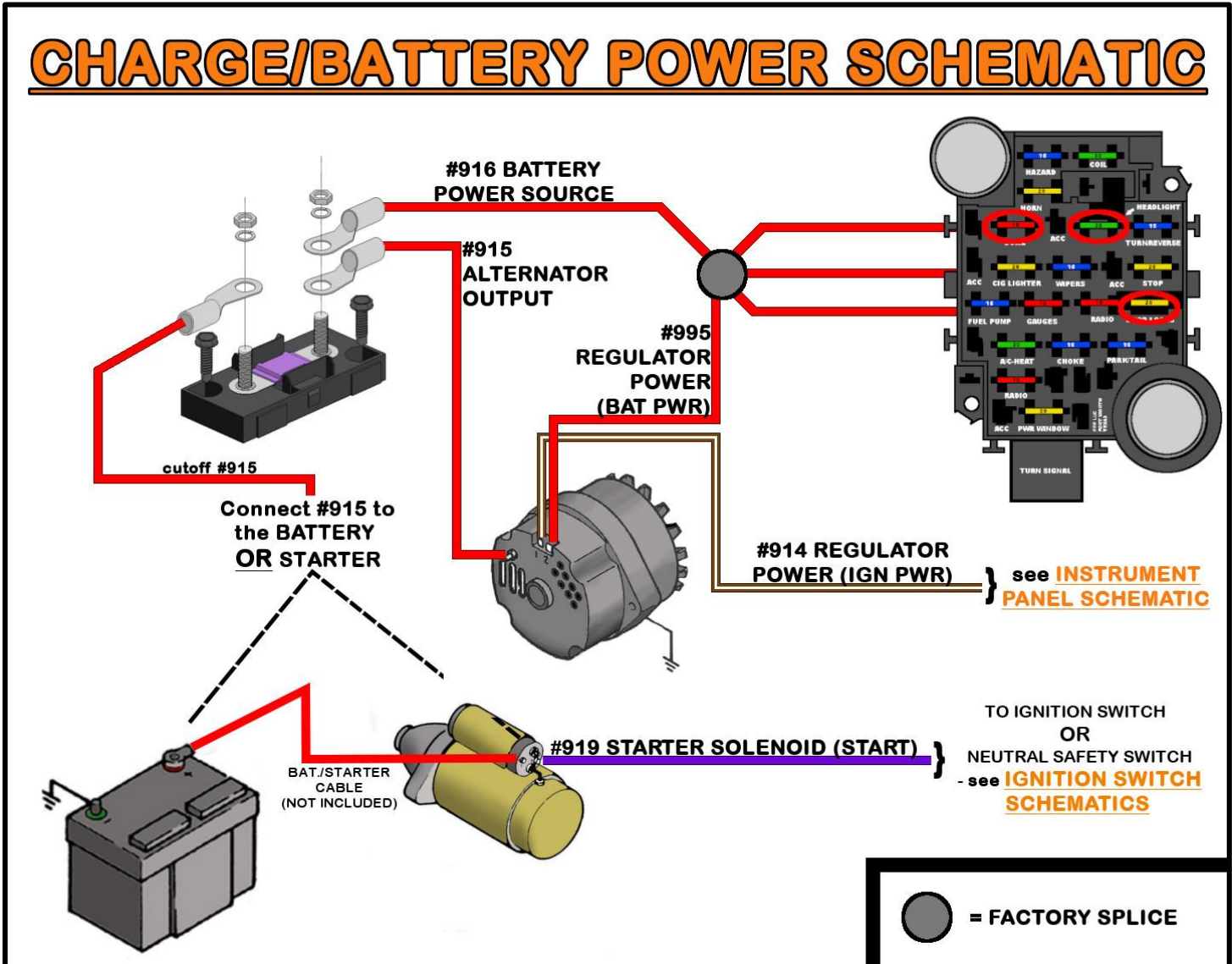

## ALTERNATOR

The alternator connections vary depending on the alternator your vehicle currently has installed. The alternator may also need to be removed in order to gain access to the connection points.

The one connection all alternators have in common is the output post. This sends power from the alternator to the battery. This connection is made using the large gauge **RED** wire rolled in the kit, it is:

**RED:** 6-gauge wire, with a tag reading **#915 ALTERNATOR OUTPUT**; this wire provides power out of the alternator to the MIDI fuse and from the MIDI fuse to the battery. This wire is not part of the harness but is a separate, rolled piece of wire provided with the kit. When connected, this wire has power at all times from the battery. See [Charge/Battery Power Schematic](#) on the previous page.



- Locate the **rubber alternator boot** and a large, **un-insulated ring terminal** from the “ALTERNATOR” bag that has the correct opening size for your alternator post.



- If the rubber boot is being used, the end will need to be cut, as shown in the photo to the right, to allow the large gauge wire to pass through.
- If the heat shrink is being used, slide it onto the **#915** wire, followed by the rubber boot. A very small amount of lubricant such as WD-40 may be applied on the inside of the rubber boot to allow the boot to slide down the wire easier.
- With the boot on, strip about  $\frac{3}{8}$ " of insulation from the charge wire and crimp the ring terminal on. You can use a hammer crimper if your hand crimper will not accept this large gauge wire/terminal.
- Connect this wire to the B+/Output stud on the alternator. Once the nut on the output post stud has been tightened, slide the boot over the nut and ring terminal installed on the alternator.



If your vehicle has an aftermarket, **ONE WIRE ALTERNATOR**, meaning it does not require a switched 12v source or regulator connections, or if the Painless or other aftermarket fuel injection harness you are using has an alternator connector, **then this output wire is the only wire used in this section at the alternator.**

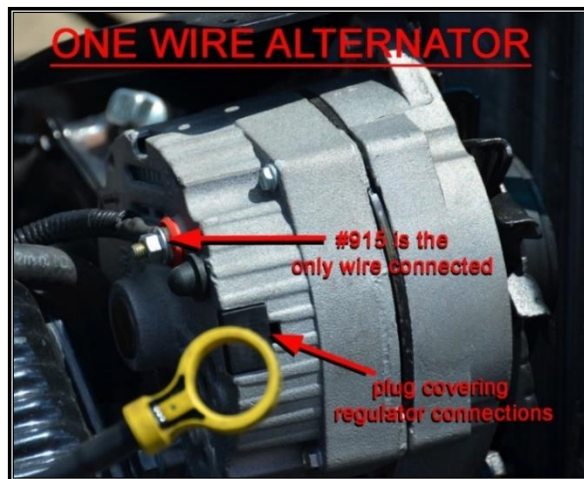

Locate the two wires intended for alternator regulator connections; they will be grouped together in the **Alternator Section**. These wires are:

**RED:** 14-gauge wire, printed **[ALTERNATOR] #995 REGULATOR POWER (BAT PWR)**; this is the sense wire, it provides a battery power source, or voltage sense, that all voltage regulators require. This wire has power at all times and comes from the large battery supply splice in the harness. **This wire will not be needed if you have a one-wire alternator or a GM CS series alternator.** See the various alternator illustrations on [pages 55 – 61](#) and the [Charge/Battery Power Schematic](#) on [page 52](#).

**BROWN/WHITE:** 18-gauge wire, **[ALTERNATOR] #914 REGULATOR POWER (IGN PWR) [INSTRUMENT PANEL]**; this is the regulator power wire and has switched ignition power from the fuse block through the alt/gen light on the instrument panel. This wire's power comes from the 20-amp PWR WINDOW fuse and has power when the ignition is in the ACCESSORY position and when in the ON/RUN position. **This wire will not be needed if you have a one-wire alternator.**

If you have a one wire alternator, and only if you have a one wire alternator, you need to insulate the ends of these wires and stow them in the harness, **THEY ARE POWER WIRES**. **#995** may also be connected to the output post of the alternator to avoid removing it from the harness since this wire goes into the big battery power splice.

The remaining alternator connections vary based on which alternator is being used. Choose the alternator that best represents the alternator found on your vehicle from those on the next few pages. Then, follow the instructions provided for your particular alternator.

# GM SI SERIES ALTERNATORS



The 10-SI and 12-SI alternators are easy to identify. They have an external fan behind the pulley (the 12-SI has enclosed style fan blades) and a 2-pin connection. This 2-pin connection is circled on the second example in the image above. These are also commonly referred to as “Delco” or “Delcotron” alternators.

The two wires, **RED #995 REGULATOR POWER (BAT PWR)** and **BROWN/WHITE #914 REGULATOR POWER (IGN PWR)**, connect to the two posts on the back edge of the alternator.

- Route the two wires to the numbered 1 & 2 terminals on the alternator and cut to length. Strip  $\frac{1}{4}$ " of insulation from both wires.
- A factory-style connector and terminals, seen in the photo to the right, are provided in the parts kit. Crimp a terminal onto each of the two wires.
- Insert the wires into the connector as shown in the diagram below. When terminal pin-out is complete, plug the connector into the alternator.



You may experience engine run-on. This is caused when the alternator back feeds voltage down the **#914** wire after the key has been turned off. This allows the ignition system to still function causing the engine to continue running even though the key is turned off or even removed from the ignition. If this should happen, unplug the alternator connector to shut the engine off. If you experience this, a remedy has been provided.

If engine run-on occurs, simply install a diode as shown. When the diode is installed inline of the **#914** wire **with the stripe towards the alternator** it lets current flow towards the alternator, but not away from the alternator back-feeding the ignition system, thus fixing the run-on issue.

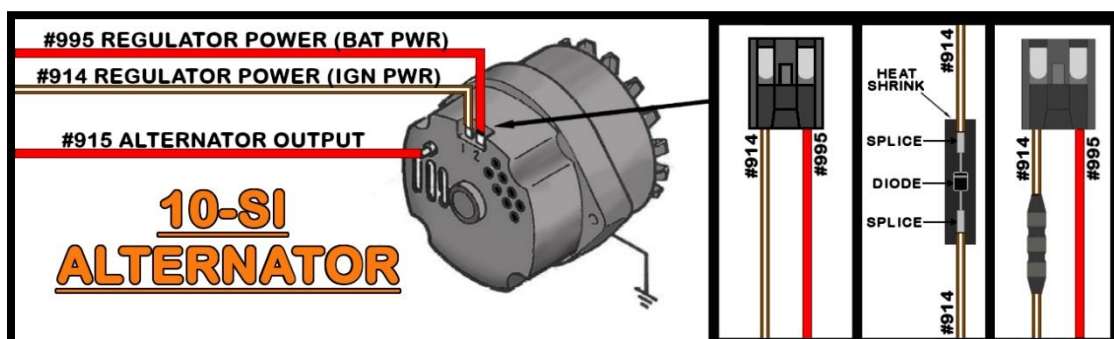



## GM CS-130 SERIES ALTERNATORS

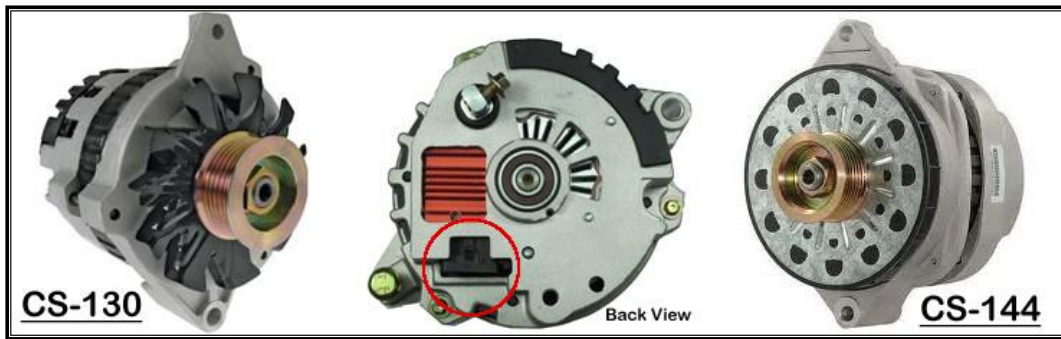

The CS-130, CS-121, and CS-144 alternators closely resemble the SI series alternators. They have an external fan behind the pulley and, generally, a plastic casing on the side and back. These alternators have a 4-pin, sealed connector, shown in the photo below and circled in the image above. The regulator will be marked P, L, S, F. This type of alternator was used on GM TPI and LT1 fuel injected engines among other late 1980's to mid-1990's GM vehicles.

The two wires **RED #995 REGULATOR POWER (BAT PWR)** and **BROWN/WHITE #914 REGULATOR POWER (IGN PWR)**, connect to the regulator on the back of the alternator.

- Route the two wires to the connector on the alternator and cut them to length. Strip  $\frac{1}{4}$ " of insulation from both wires.
- The factory 4-pin alternator connector from a factory GM harness is needed (seen to the right). It is not included with this Painless chassis harness.
- The CS-130 alternator requires a resistance on the **BROWN/WHITE #914** wire. Without this resistance, the regulator on the alternator will burn up. The resistor\* will simply need to be installed inline on the **#914** wire as shown in the diagram on the next page.

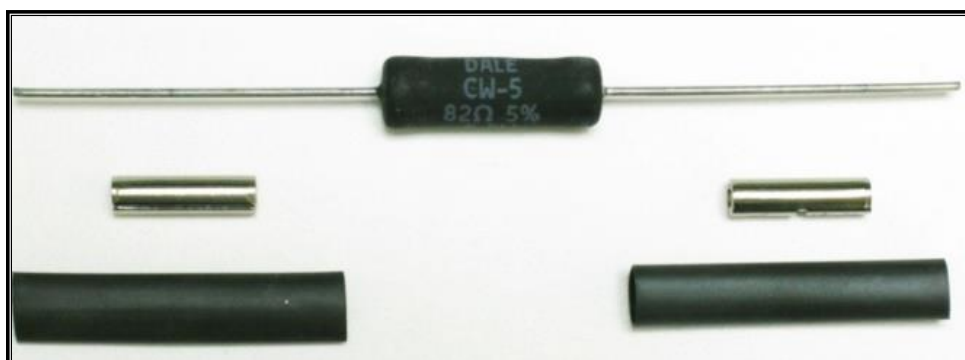
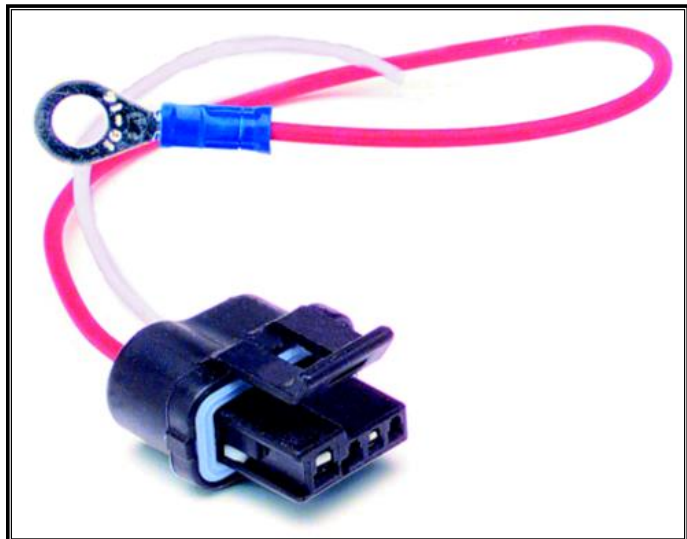

- Use splices and heat shrink to splice the CS-130 pigtail to the #914 and #995 wires according to the diagram below.

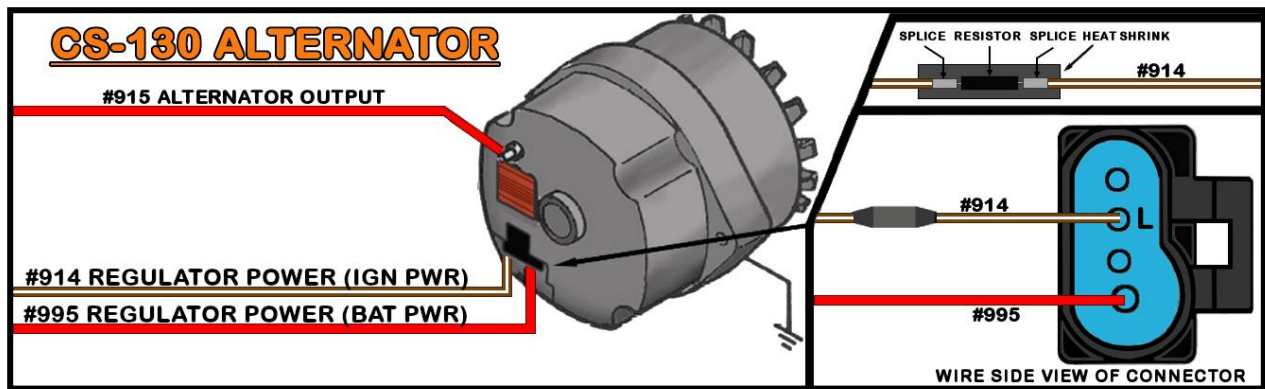

## GM CS-130D SERIES ALTERNATORS

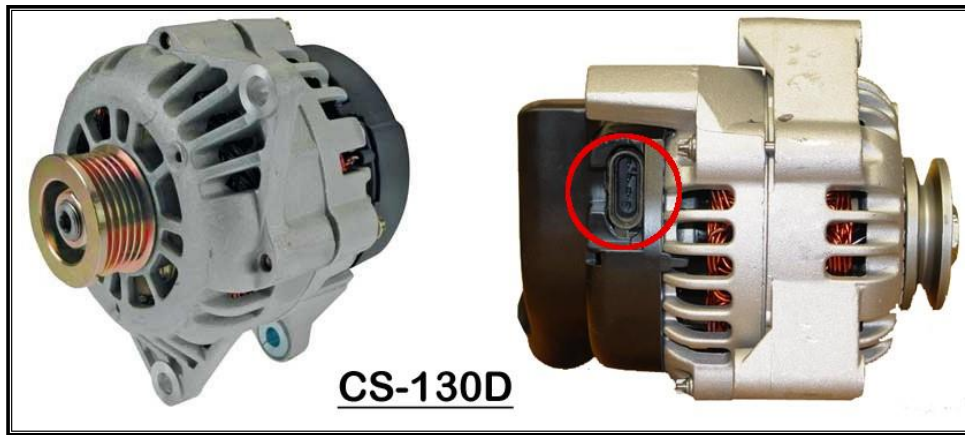

The CS-130D can be spotted by the lack of an external fan behind the pulley. These alternators have an internal fan and a plastic casing on the back. These alternators have an elongated, oval, 4-pin, sealed connector, seen circled in the image above. The regulator will be marked P, L, I, S. This type of alternator was used on many engines, including the GM LS series, Vortec, and Gen. III Vortec truck fuel injected engines.

There are two wires in the **Alternator Section**: **RED #995 REGULATOR POWER (BAT PWR)** and **BROWN/WHITE #914 REGULATOR POWER (IGN PWR)**. For the CS-130D alternator, only the **BROWN/WHITE #914** is used. The **#995** may be connected to the alternator output post or removed from the harness.

- Route the **BROWN/WHITE #914** to the connector on the alternator and cut to length. Strip  $\frac{1}{4}$ " of insulation.
- The factory, 4-pin alternator connector from a factory GM harness or a CS-130D pigtail purchased from Painless (part **#30705**; see photo), needs to be used.
- The CS-130D alternator requires a switched power source to pin "I" of the regulator and a resisted power source on the wire going to pin "L" of the regulator. Without this resistance, the regulator on the alternator will burn up. The resistor simply needs to be installed inline on the pin "L" wire, **#914**, as shown in the diagrams on the next page.
- Using a splice and heat shrink, splice the CS-130D pigtail to the **BROWN/WHITE #914** wire according to one of the diagrams on the next page.



Both diagrams accomplish the same task: they use the **BROWN/WHITE #914 REGULATOR POWER (IGN PWR)** wire to provide a switched power source and a resisted power source to the 2 wires of a CS-130D alternator pigtail/connector when a charge indicator light is NOT being used. Pick the method that easiest for you to understand.

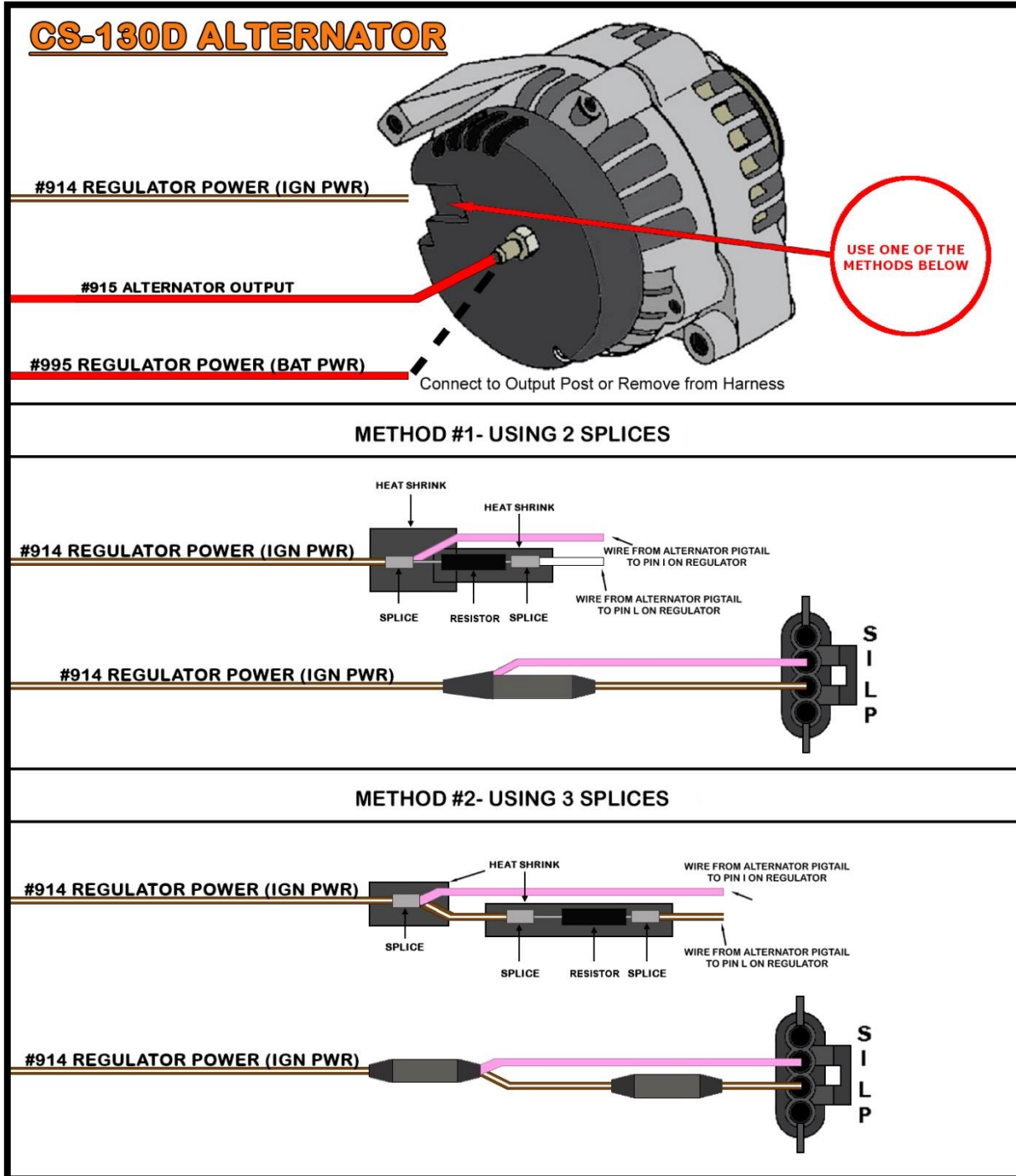

## GM EXTERNALLY REGULATED ALTERNATORS

The two wires, **RED #995 REGULATOR POWER (BAT PWR)** and **BROWN/WHITE #914 REGULATOR POWER (IGN PWR)**, connect to the regulator.

- Route the two wires of the Painless harness to the connection point on the regulator, cut to length, and strip  $\frac{1}{4}$ " of insulation from both wires.
- The factory 2-pin alternator connector and 4-pin regulator connector from a factory GM harness need to be used. Due to a lack of usage by most customers, these connectors are not included with this Painless chassis harness. If you do not have these connectors, they can be obtained online, at a local auto parts store, or you can use the loose piece insulated terminals in the parts kit to make connections.
- Connect the **BROWN/WHITE #914** wire to the "4" terminal on the regulator.
- Connect the **RED #995** to the "3" terminal on the regulator.

Two 14-gauge wires, which run from the regulator to the alternator, and a 14-gauge wire for a ground need to be provided by the installer to finish the connections. **These wires are not in the Painless harness.**

- Connect the "2" terminal on the regulator to the "R" terminal on the alternator. This was a white wire from the factory.
- Connect the "F" terminal on the regulator to the "F" terminal on the alternator. This was a blue wire from the factory.
- The last connection will be connecting a wire from the "G" post on the alternator to a chassis ground source.

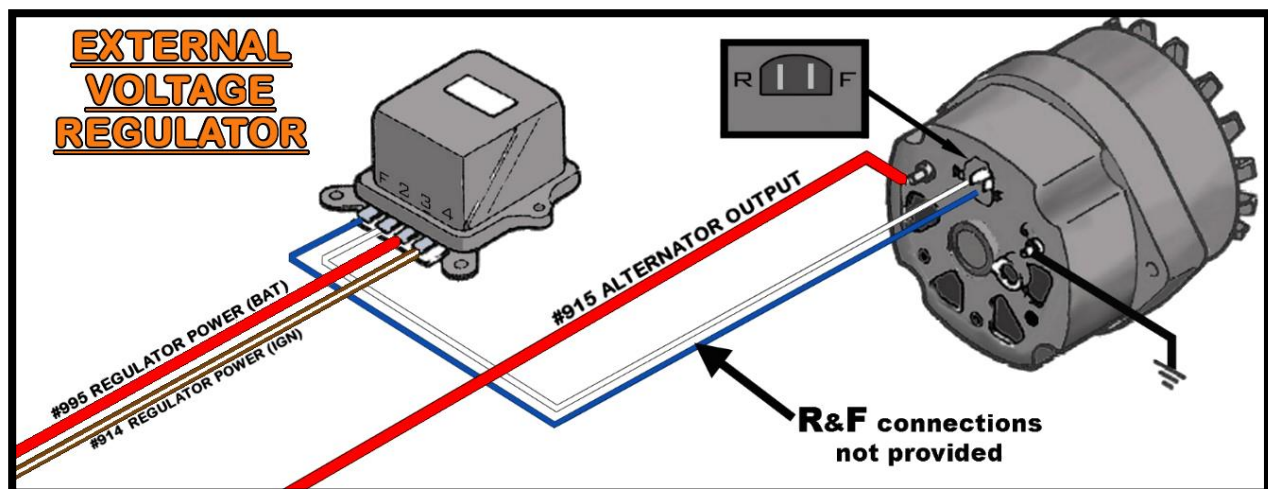

## FACTORY GENERATORS

- Connect Generator ARMATURE terminal (A) to Voltage Regulator terminal A with a user-supplied 12-gauge wire.
- Connect Generator FIELD terminal (F) to Voltage Regulator terminal F with a user-supplied 14-gauge wire.
- Be sure both the generator and the voltage regulator are securely grounded. The voltage regulator may have a terminal for this purpose (labeled "G"), or you may have to ground the regulator case.
- Route **RED #916** to the MIDI fuse and cut to length.
- Connect **RED #916** to one side of the MIDI fuse along with the cut-off portion of **RED #916**.
- Route the cutoff portion of **RED #916** to the Voltage Regulator terminal B. NOTE: if the cutoff portion is too short, you will need to supply a 10-gauge wire.
- Connect the separate **RED #915** to the other side of the MIDI fuse the route to the battery or starter.
- Insulate and stow **BROWN/WHITE #914**.

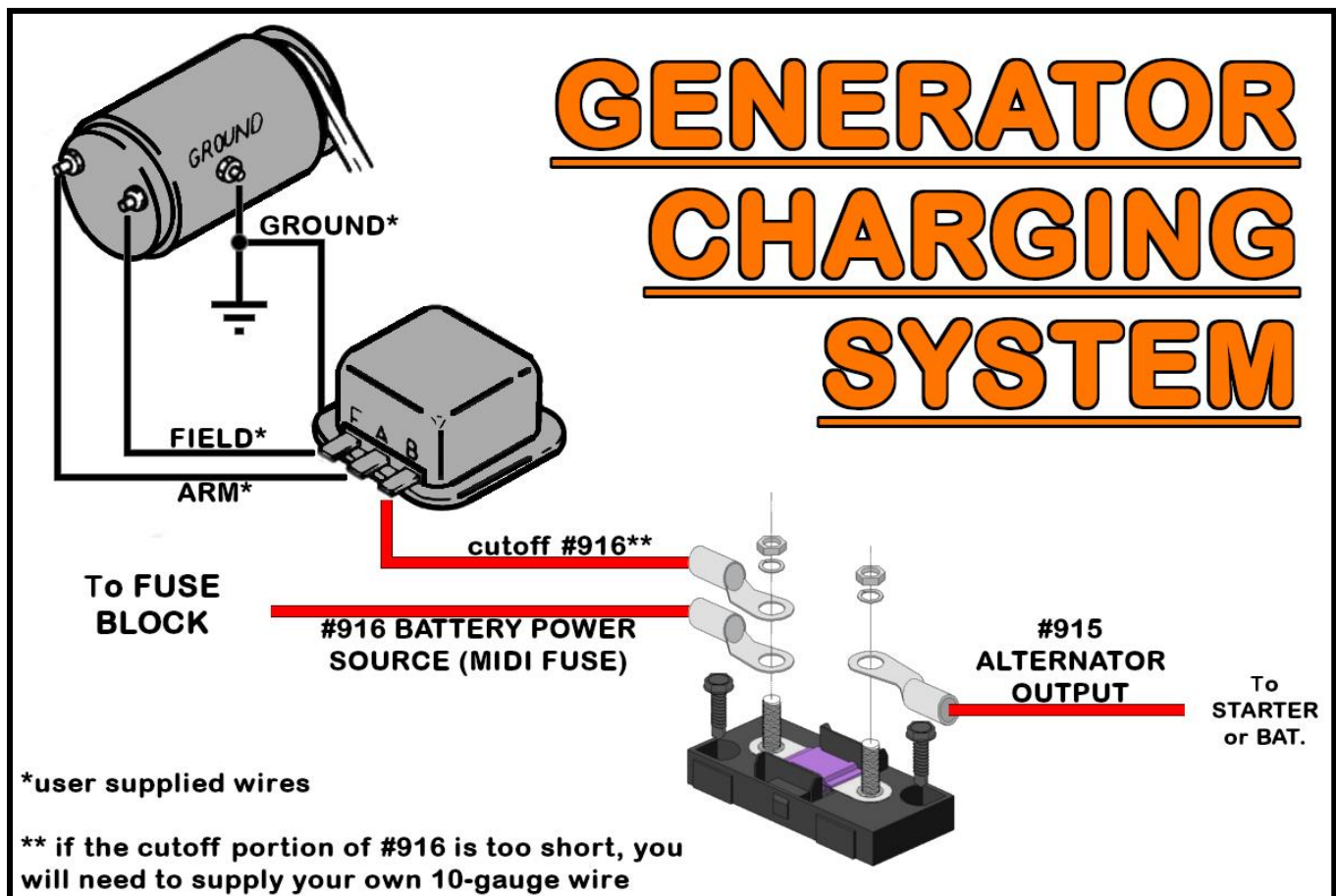

## **MIDI FUSE**

A large, inline MIDI fuse is included in the “ALTERNATOR” bag kit. This inline fuse provides a fused link between the alternator and battery.

- Find a suitable location to mount the supplied fuse holder. Use the  $\frac{3}{4}$ ” **self-tapping screws** from the parts kit.

With the fuse holder now mounted, locate the following two wires:

**RED:** 8-gauge wire, printed **[ENGINE SECTION] #916 BATTERY POWER SOURCE (MIDI FUSE)**; all power sources in this Painless harness originate from this wire. This wire provides battery power to the fuse block, which in turn supplies battery power to the ignition switch, which provides switched power. During normal operation, this wire has constant battery power at all times.

**RED:** 6-gauge wire, rolled separately from the harness with a tag reading **#915 ALTERNATOR OUTPUT**; this wire provides power from the alternator to the battery through the MIDI fuse. See [Charge / Battery Power Schematic](#) on [page 52](#). The other end of this wire connects to the output post of the alternator.

- Route the **#915** and **#916** wires to one side of the fuse holder and cut the wires to length. **DO NOT DISCARD THE CUT OFF PORTION OF #915.**

The length of excess wire cut from the **#915** wire will be used to connect the other side of the fuse to the “+” side of the vehicle’s battery or to the battery post on the starter solenoid. **DO NOT CONNECT THE #915 TO THE ACTUAL BATTERY AT THIS TIME.** If routed to the starter solenoid, this wire will NOT replace the battery cable needed by the starter from the positive side of the battery to the “BAT” or (+) post of the starter solenoid.

- Make connections to both sides of the fuse holder with the large ring terminals with the small, **#10 hole** provided with the kit. You can use a pair of pliers if your crimpers will not accept this large gauge wire/terminal. The heat shrink supplied with this kit is intended to cover the crimped end of each of these (2) ring terminals See [Charge / Battery Power Schematic](#) on [page 52](#).
- Once you install the ring terminals onto both studs of the fuse holder, the fuse can be installed and everything can be tightened down with the two retaining nuts provided with the fuse holder. Once everything is tightened, the cover can be reinstalled. Depending on how your crimp flares the ring terminal, the cover may or may not need slight trimming to snap into place.

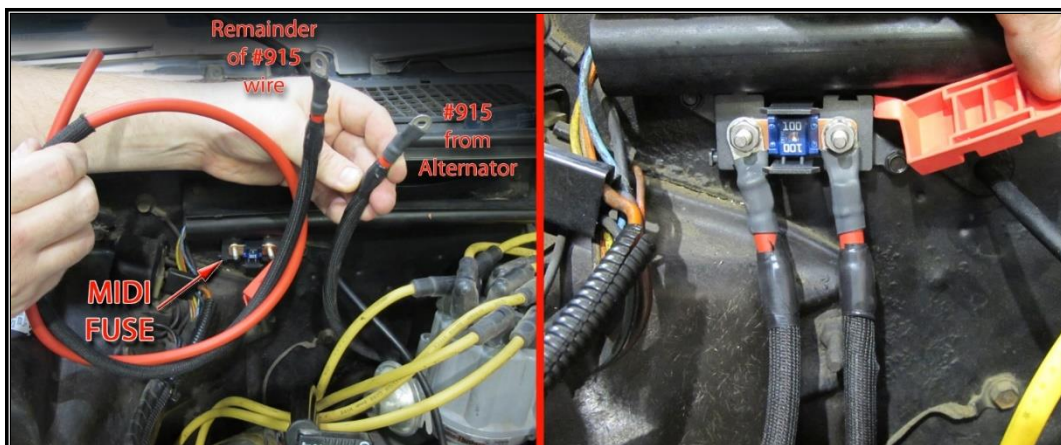

## STARTER SOLENOID

The connections to the starter solenoid vary depending on your ignition system, the location of a neutral safety/clutch switch, and your connection point on the battery power source for the MIDI fuse.

One connection to the starter solenoid all vehicles share is:

**PURPLE:** 12-gauge wire, printed [IGNITION SWITCH] #919 STARTER SOLENOID (START) [NSS]; this wire will supply the solenoid with a switched power source from the ignition switch. This power will activate the starter solenoid causing it to turn the engine over for startup. This wire will only have power when the ignition switch is in the *Start/Crank* position.

- This wire begins at the ignition switch and connects to the NSS. The cutoff portion will then connect to the other side of the NSS and be routed out to the starter solenoid
- Route the **PURPLE #919** and the ballast bypass, if needed, to the starter solenoid and cut to length. If the remainder of **#916** from the MIDI fuse is being connected to the “BAT” or (+) post of the starter solenoid, it may be routed at this point as well. Be sure to keep all wires away from the exhaust manifold or header.
- Locate ring terminal and heat shrink from the parts kit that best fit the posts found on the starter solenoid and install onto the wires going to the starter solenoid. Be sure to apply heat shrink to protect the crimp.
- The **PURPLE #919** wire will connect to the “START” or “S” post on the solenoid and the bypass wire, if needed, will connect to the “I” or “R” post of the solenoid.
- If you are connecting the battery supply to the MIDI fuse to the battery cable/post on the starter, connect it now. **BE SURE THE BATTERY CABLE IS DISCONNECTED FROM THE BATTERY BEFORE MAKING THIS CONNECTION.**

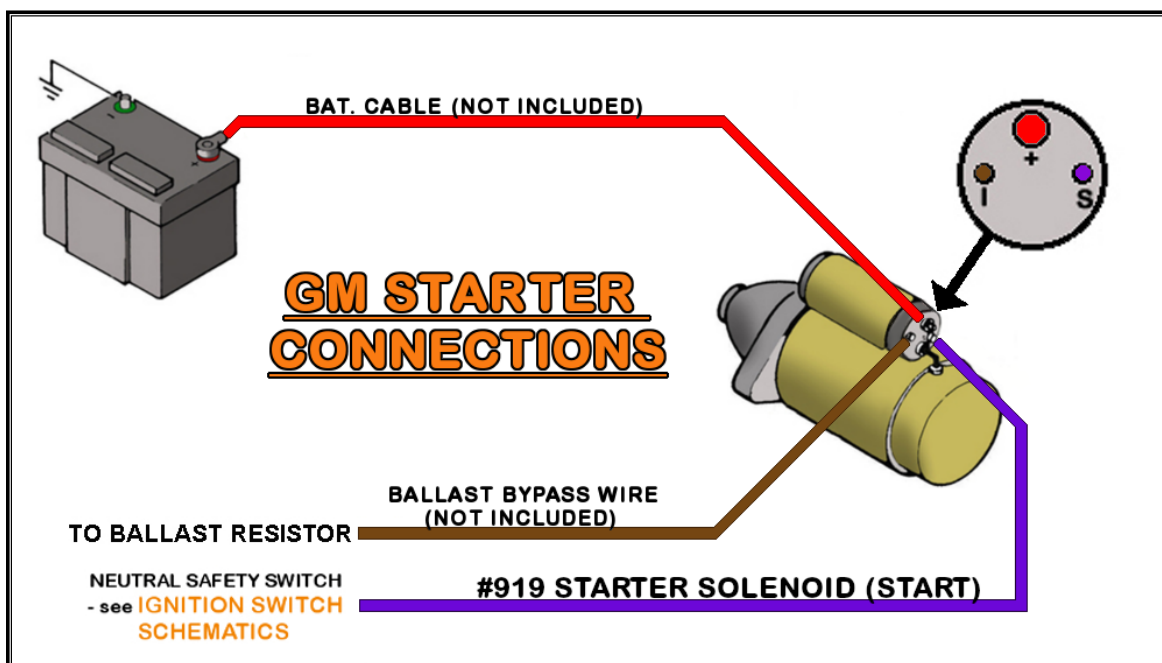



# DIMMER SWITCH

These three wires provide power to the headlights for low beam and high beam power. These wires can be seen in the [Headlight Dimmer Switch Schematic](#) below. They are:

**YELLOW:** 14-gauge wire, printed **[DIMMER SWITCH] #907 DIMMER SWITCH [HEADLIGHT SWITCH]**; this wire provides power to the dimmer switch from the headlight switch. This wire has power whenever the headlight switch is in the “HEADLIGHT ON” position.

**TAN:** 14-gauge wire, printed **#909 LOW BEAM**; this wire provides power from the dimmer switch and into a splice with two other wires. The other two wires feed power to each low beam of the headlights, as seen in the [Front Light Section Schematic](#) on [page 40](#). Once connected, this wire has power when the headlight switch is in the “HEADLIGHT ON” position and the dimmer switch is in the “LOW BEAM” position.

**LT. GREEN:** 14-gauge wire, printed **#908 HIGH BEAM**; this wire provides power from the dimmer switch and into a splice with three other wires. The other wires feed power to each high beam of the headlights and the high beam indicator as seen in the [Front Light Section Schematic](#) on [page 40](#). Once connected, this wire has power when the headlight switch is in the “HEADLIGHT ON” position and the dimmer switch is in the “HIGH BEAM” position.

For those using a GM style switch, like [Painless part #80150](#), a connector and terminals have been provided. If this style of connector does not work for your dimmer switch, use the single pin connectors show below.

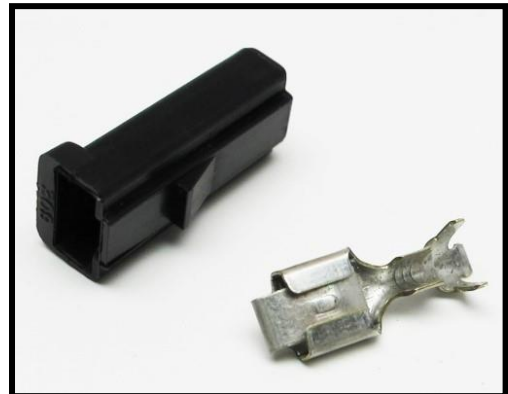

## 1955 – 1956

- The dimmer wires should have been routed to the wheel well, just below the driver floor pan on [page 27](#). To access the wires the cover plate (seen to the right) will need to be removed.
- Remove the plate, route all three wires to the dimmer switch, and cut to length.
- Connect the three wires to the dimmer switch as shown in the diagram on the next page.



## 1957

If you have a 1957 model, the dimmer switch connection will be made on the inside.



- The dimmer wires should have been re-routed out of the bottom of the fuse block on [page 18](#). To access the dimmer switch connections the cover plate (seen to the left) will need to be removed.

- Remove the plate, route all three wires to the dimmer switch, and cut to length.

- Connect the three wires to the dimmer switch as shown in the diagram below.

### HEADLIGHT DIMMER SWITCH

**1955-1956**

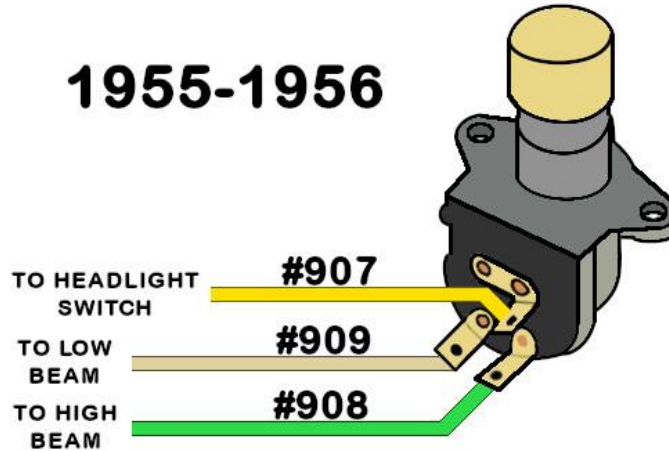

### HEADLIGHT DIMMER SWITCH

**1957 & GM  
AFTERMARKET**

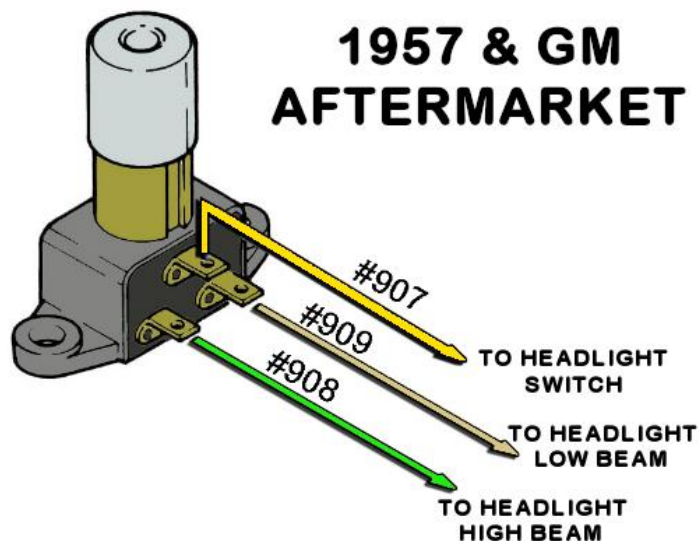

# INTERIOR HARNESS

Now that the Engine Sections are wired, move to the interior of the vehicle.

Before you make any connections on the inside of the vehicle, let's address the component switches: like the headlight switch, brake switch, turn signal switch, ignition switch, and headlight dimmer switch.

With older vehicles and hot rods in general, many times switches are replaced by what's available or what previous owners had lying around. In some cases, these switches are not marked and there is no idea what pins on the switch controls each function. If you are unsure about the positions or functionality of the switches currently in your vehicle and are not really up to the task of figuring out what each pin does, Painless offers several solutions. We have switch kits and also sell switches individually.

A common switch kit that many people choose is **Painless part #80121**. This kit provides you with a new headlight switch, new dimmer switch, door jamb switches, and ignition switch, all marked with each terminal's function. Part numbers for individual switches are given in each individual section.

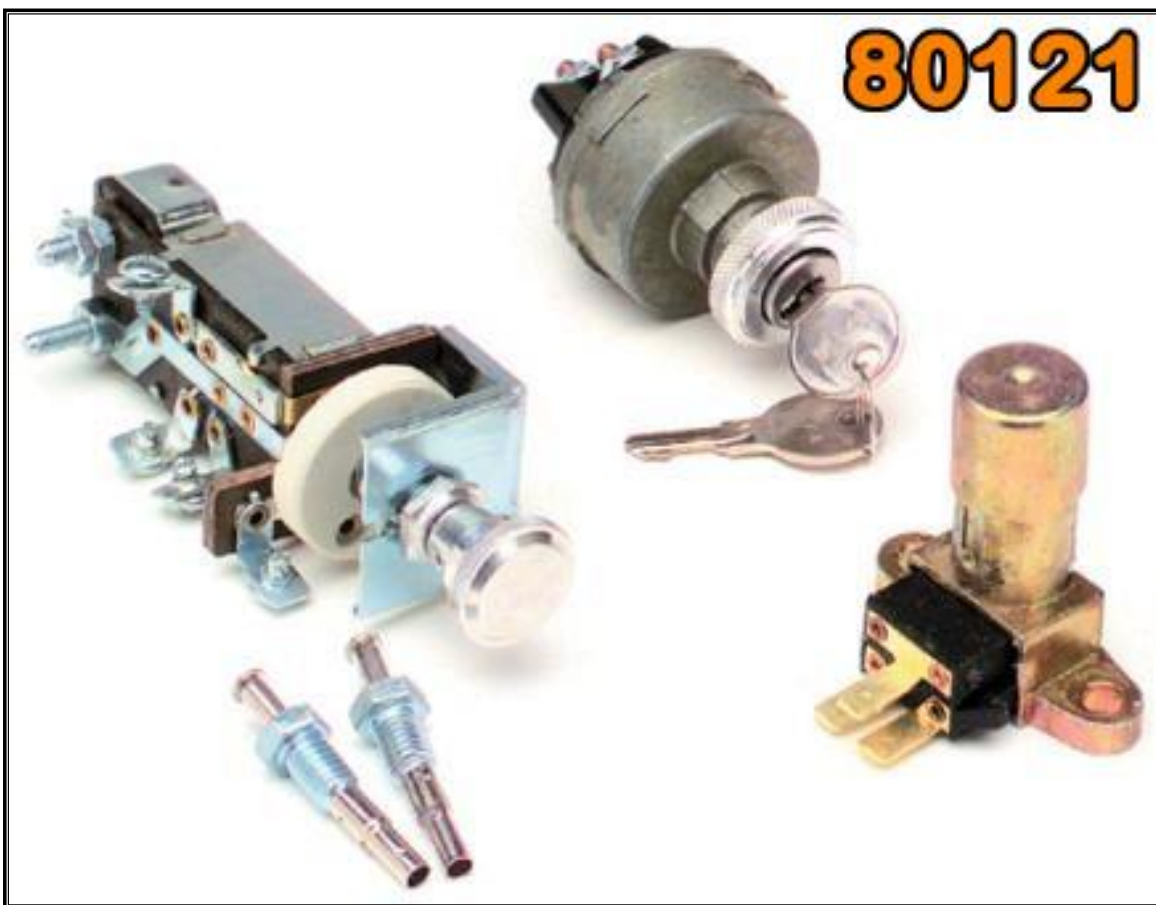

# DRIVER COURTESY LIGHT SECTION

The Driver Courtesy Light Section has three wires for the courtesy light and jamb switch. The Passenger Side Courtesy Lights are covered on [page 121](#).

## DRIVER DOOR JAMB SWITCH

The door jamb switch provides a ground activation for the courtesy lights and dome light. When the door is opened, the plunger on the switch extends out as it is no longer being pushed in by the door. When the plunger extends, the contact point on the back of the switch contacts the body of the switch, which is grounded through the mounting into the metal door jamb. This grounding gives the wire attached to the switch a ground source which will then cause the interior lights to turn on.

Locate the wire in the courtesy light section intended for the driver door jamb switch. It is:

**WHITE:** 18-gauge wire, printed **[COURTESY LIGHT] #961 DRIVER SIDE DOOR JAMB SWITCH**; this wire is spliced to other white wires leading to the dome light, courtesy light, headlight switch, and the passenger side door jamb switch. This wire is grounded anytime either door is opened, or when the headlight switch knob is rotated to the "DOME LIGHT ON" position. This wire can be seen in the [Courtesy Lights Schematic](#) on [page 69](#).

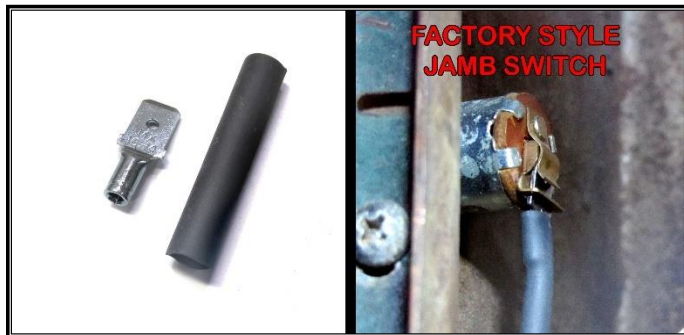

- Route the **WHITE #961** wire to the driver-side door jamb switch and use a  $\frac{1}{4}$ " **uninsulated male terminal** and **heat shrink** from the parts kit to connect to a factory-style jamb switch.

- If you have an aftermarket switch, you may need to supply a terminal. If you find that your door jamb switch has two tabs, it does not matter which tab the **#961** connects to.

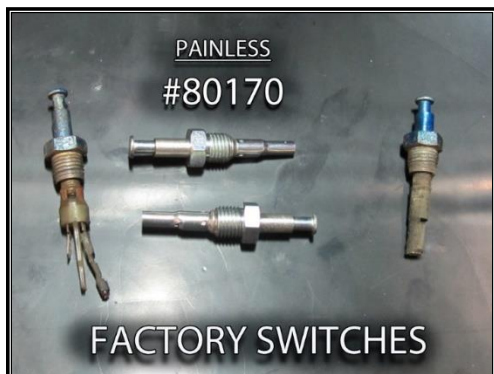

If this is a new build/restoration or your original switches are just in bad shape and new switches are needed, Painless offers factory-style GM jamb switches as [part #80170](#). Please note that [part #80170](#) is for one switch, and each door requires a switch. Use the **18-20 gauge insulated bullet terminal** from the parts kit to connect to this stile switch.

## **DRIVER COURTESY LIGHT**

This connection allows the driver side under the dash/floorboard of the vehicle to be illuminated any time a door is open or when the headlight switch is activating the dome light.

These wires can be seen in the [Courtesy Light Schematic](#) on the next page, these wires are:

**ORANGE:** 18-gauge, **[COURTESY LIGHT] #971 DRIVER COURTESY LIGHT (BAT PWR)**; this wire provides power to the driver courtesy light from the 10-amp DOME fuse on the fuse block. This fuse is battery-powered and always has power.

**WHITE:** 18-gauge, printed **[COURTESY LIGHT] #961 DRIVER COURTESY LIGHT GROUND**; this is the ground wire that activates the courtesy light. When this wire is grounded, it completes the voltage path and causes the light to illuminate. This ground comes from either of the door jamb switches, if the door is opened, or the headlight switch when it is turned to the "DOME LIGHT ON" position.



- Locate a **lamp socket** and **terminals** from the parts kit shown above. This light socket can use either a **63 or 67 series bulb (not included)**.
- Locate a suitable mounting location under the driver's side of the dash. The light socket has a small hole in a mounting tab to allow mounting. This kit provides both **1/2" self-tapping screws** and **small zip ties** to accommodate the various ways you might affix the socket. You may also use screws that hold existing trim. **Do not mount the socket at this time.**
- Route the wires to where the socket will be mounted and cut to length.
- Strip **1/4"** of insulation from each wire and install the terminals; crimp the smaller, brass terminal to the **WHITE #961** wire and the larger terminal to the **ORANGE #971** wire.
- Insert the terminals into the connector, install a **#67 bulb (not included)**, and mount the socket.

# COURTESY LIGHT SECTION

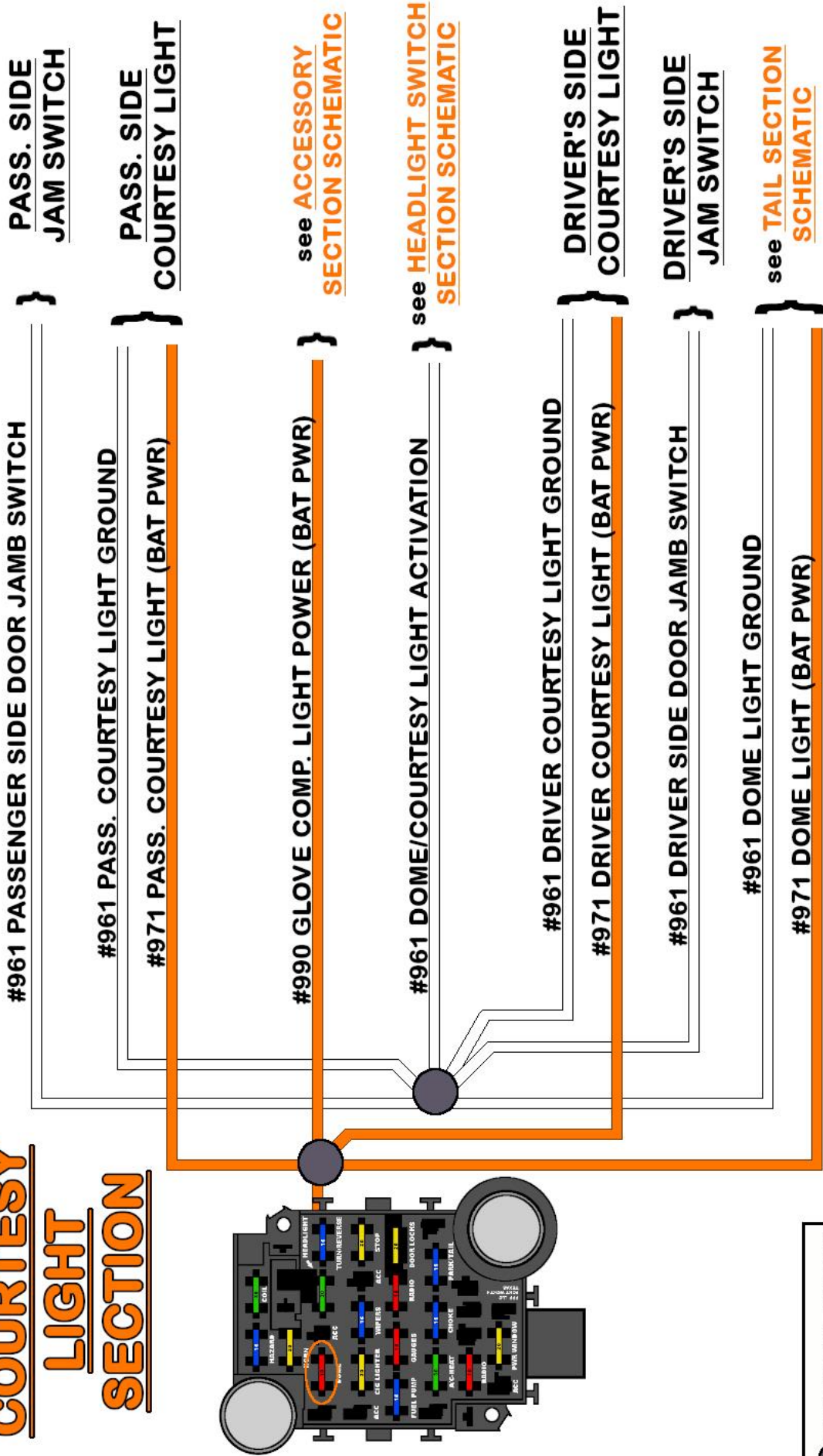

# HEADLIGHT SWITCH

The headlight switch's connections send power to the headlights, front park/marker lights, rear taillights, and component backlighting, such as gauges and the radio. These wires can be seen in the [Headlight Switch & Dimmer Switch Schematic](#) on the next page. These seven wires are:

**RED:** 12-gauge wire, printed **[HEADLIGHT SWITCH] #928 HEADLIGHT SWITCH POWER (BAT PWR)**; this wire provides constant battery power to the headlight switch for headlight operation. This wire comes from the 30-amp HEADLIGHT fuse on the fuse block.

**ORANGE:** 14-gauge wire, printed **[HEADLIGHT SWITCH] #959 PARK/TAIL POWER IN (BAT PWR)**; this wire supplies constant battery power for the park/tail lights as well as for the gauge backlighting. This wire comes from the 15-amp PARK/TAIL fuse on the fuse block.

**PURPLE:** 18-gauge wire, printed **[HEADLIGHT SWITCH] #927 FRONT PARK LIGHT POWER**; this wire supplies power to the park lights. This wire has constant battery power any time the headlight switch knob is pulled to Park Light ON and, depending on your switch, the Headlight ON position.

**BLACK:** 16-gauge wire, printed **[HEADLIGHT SWITCH] #929 TAILLIGHTS**; this wire supplies power to the taillights. This wire has constant battery power any time the headlight switch knob is pulled to both the park light ON and headlight ON positions.

**GREEN:** 16-gauge wire, printed **[HEADLIGHT SWITCH] #930 GAUGE/PANEL LIGHTING**; this wire provides power to the gauge lights, ignition switch light, and other panel backlighting. This wire should have constant battery power any time the headlight switch knob is pulled to both the park light ON and headlight ON positions. This wire doubles with the **GREY #930** wire at the headlight switch.

**GREY:** 18-gauge wire, printed **[AFTMKT GAUGES] #930 BACKLIGHT POWER**; this wire provides backlight power to the aftermarket gauge section. This wire should have constant battery power any time the headlight switch knob is pulled to both the park light ON and headlight ON positions. This wire doubles with the **GREEN #930** wire at the headlight switch.

**YELLOW:** 14-gauge wire, printed **[DIMMER SWITCH] #907 DIMMER SWITCH [HEADLIGHT SWITCH]**; this wire supplies power to the dimmer switch for headlight operation. This wire has constant battery power any time the headlight switch knob is pulled to the headlight ON position.

**WHITE:** 18-gauge wire, printed **[HEADLIGHT SWITCH] #961 DOME/COURTESY LIGHT ACTIVATION**; this wire provides a ground source for the interior dome/courtesy lights.

The use of some or all of these wires will depend on the headlight switch you use. Factory-style switches will use all wires, whereas most universal switches may not require all of them. Diagrams have been provided of the factory switches, along with universal switches which Painless also offers.

# HEADLIGHT SWITCH & DIMMER SWITCH SCHEMATIC

see **FRONT LIGHT SECTION SCHEMATIC**

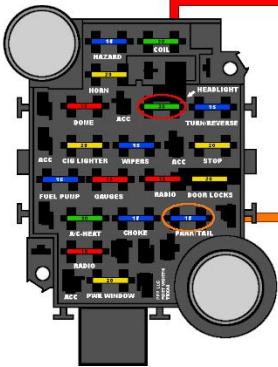

see **TAIL SECTION SCHEMATIC**

● = **FACTORY SPLICE**

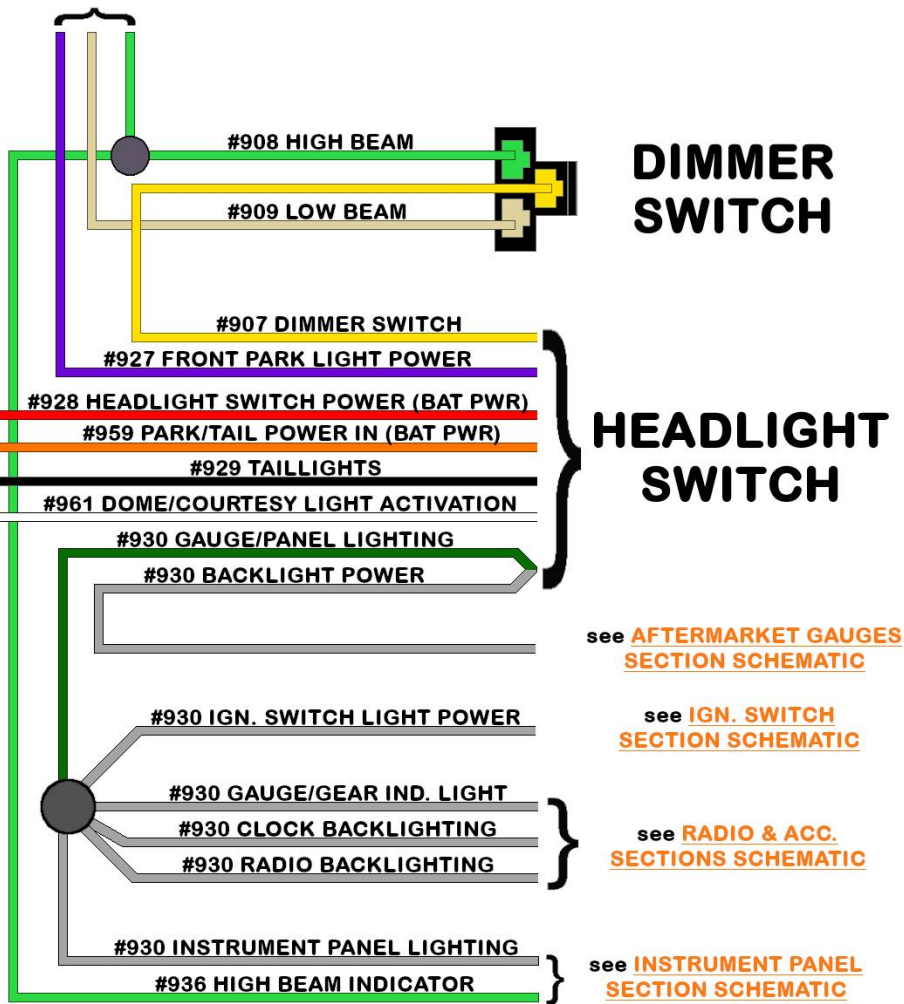

see **AFTERMARKET GAUGES SECTION SCHEMATIC**

see **IGN. SWITCH SECTION SCHEMATIC**

see **RADIO & ACC. SECTIONS SCHEMATIC**

see **INSTRUMENT PANEL SECTION SCHEMATIC**

## 1955 – 1956



- Locate **(7) 56-series single pin connectors** from the parts kit and install.
- Once the connectors are installed connect them to the headlight switch using the diagrams on the next page.



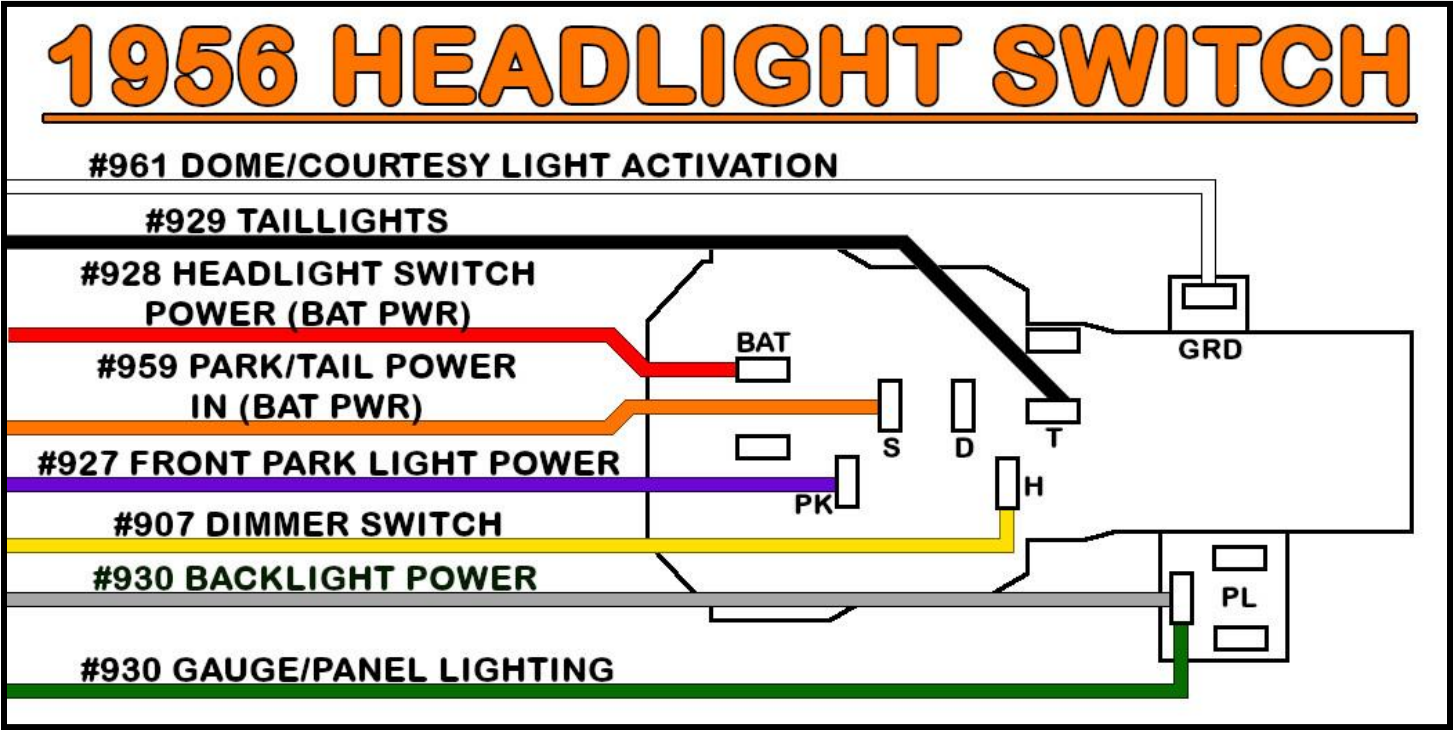
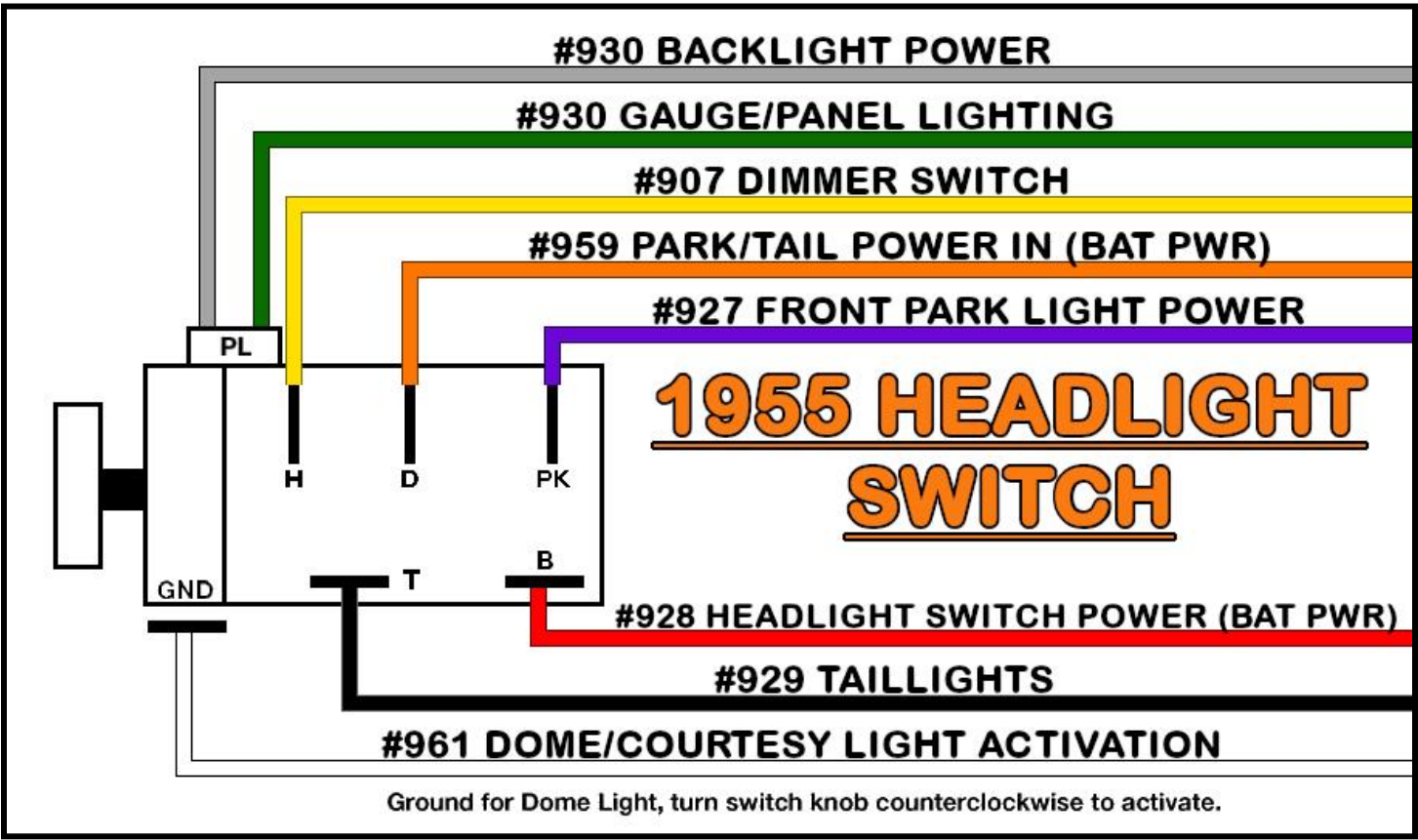

## 1957



- Locate the **7-pin headlight switch connector** from the parts kit. Then install the wires into the connector using the diagram below. **Remember, the schematics are from the wire side of the connector.**
- Once the wires are installed, plug the connector into the back of the headlight switch.

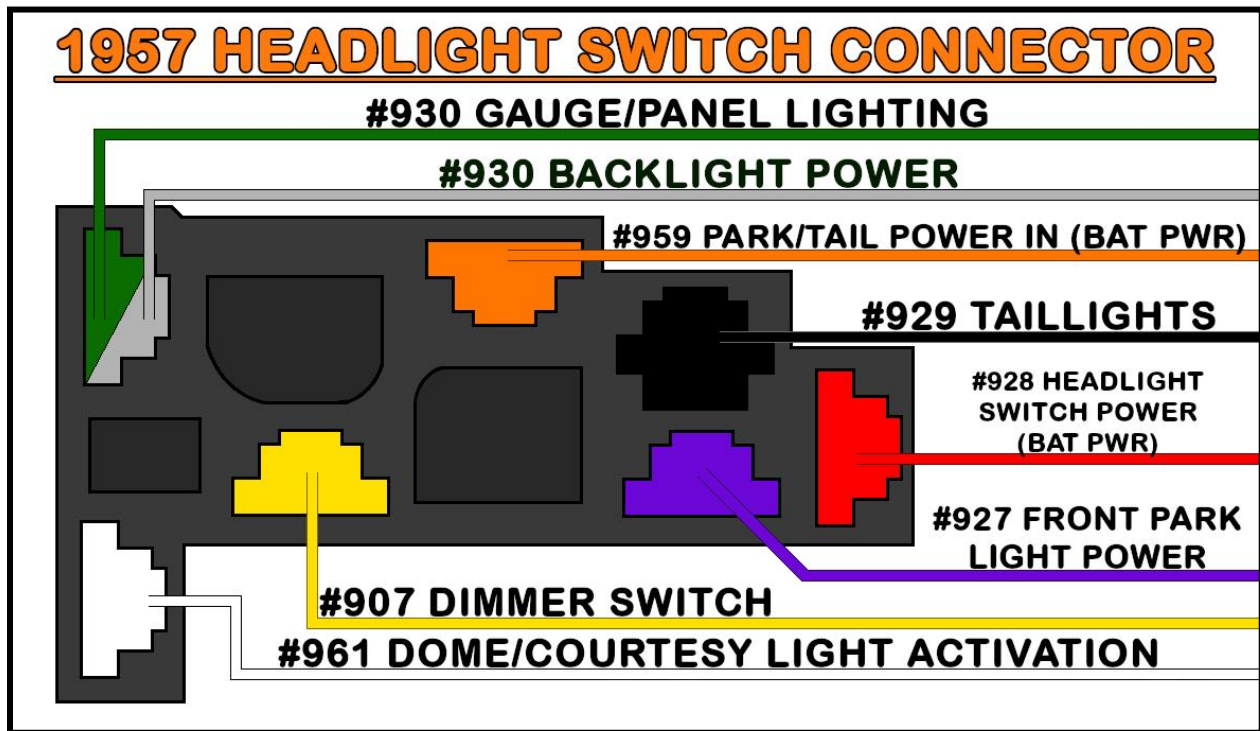

If your switch does not have a separate terminal for gauge backlighting, connect wire **#930** with the taillight wire **#929** at the switch. If your switch doesn't have separate tail and park terminals, **#927** and **#929** wires will connect at the switch. In the case you do not have a backlighting terminal and also do not have separate tail/park terminals, all three wires **#930**, **#927**, and **#929** will all share the same terminal on the switch.

# PAINLESS UNIVERSAL HEADLIGHT SWITCHES

Painless offers several universal switches as well, and even one with hi-low beam dimmer functions. Use the following diagrams to connect to either of the universal headlight switches offered by Painless. Use the ring terminals found in the parts kit to make these connections.

If your switch does not have a separate terminal for gauge backlighting, connect wire #930 with the taillight wire #929 at the switch. If your switch doesn't have separate tail and park terminals, #927 and #929 wires will connect at the switch. In the case you do not have a backlighting terminal and also do not have separate tail/park terminals, all three wires #930, #927, and #929 will all share the same terminal on the switch.

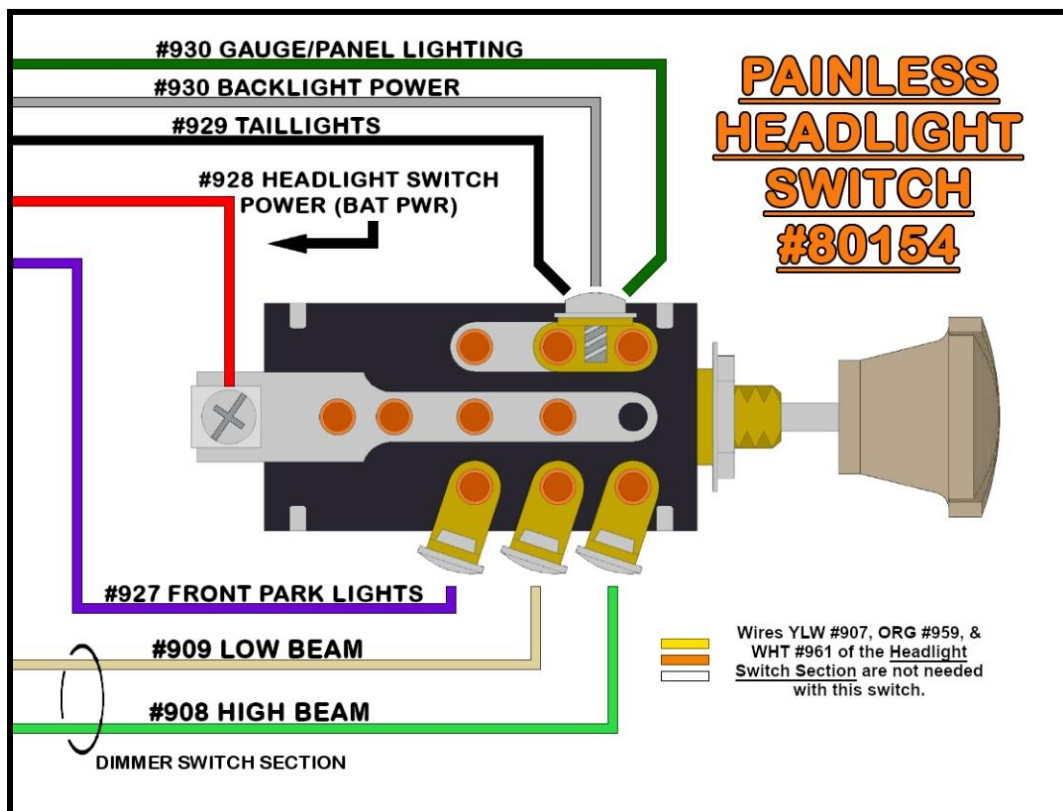
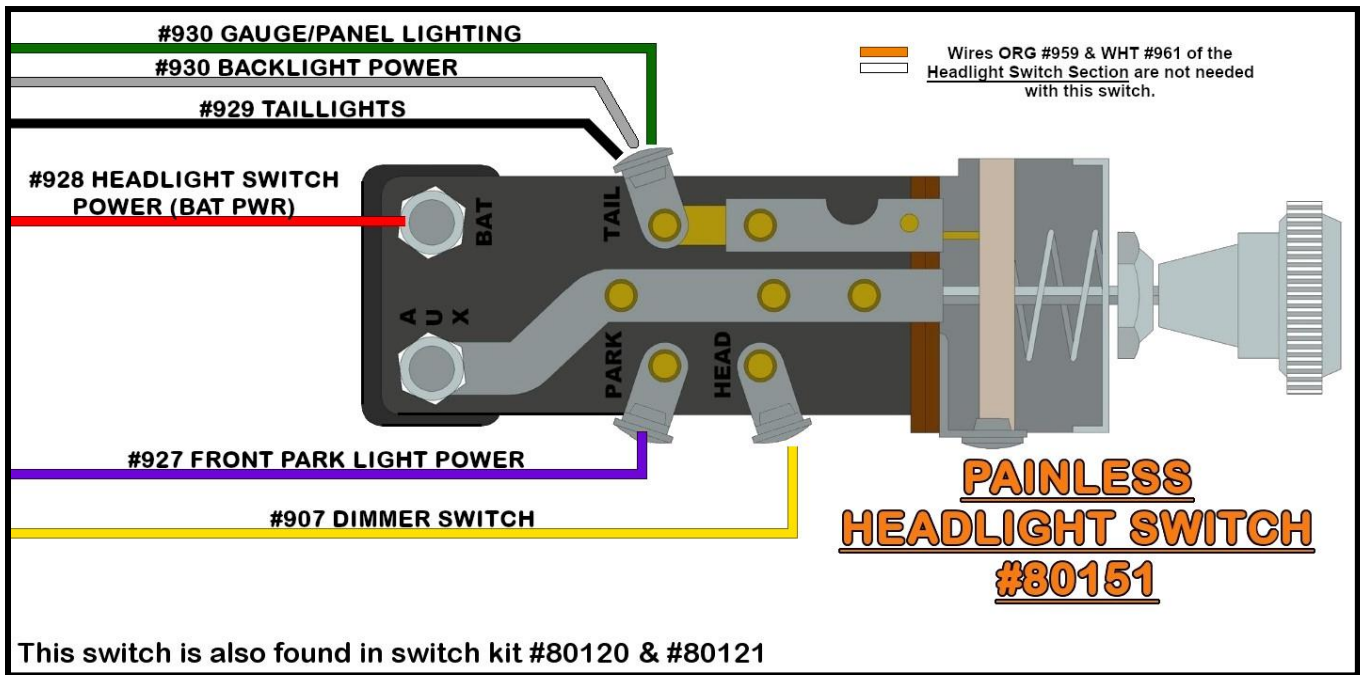

# WIPER SWITCH

Locate the **YELLOW #905** wire from the **Accessory Section** for wiper switch power. This wire should have been rerouted to the switch on [page 19](#). Also please note, this harness does not include any additional wires for vehicles with wipers due to most aftermarket wiper assemblies having separate harnesses/wires. If you do not have an electrical wiper system, this wire can be used to power some other accessory so long as the max amperage does not exceed 10 amps or it can be capped and stowed away.

**YELLOW:** 16-gauge wire, printed **[ACC. SECTION]#905 WIPER SWITCH POWER (IGN PWR)**, this wire supplies switched ignition power to the wiper motor/switch from the 15-amp WIPERS fuse on the fuse block.

- Route the wire to the wiper switch, cut to length, and strip  $\frac{1}{4}$ " of insulation from the wire
- Refer to your factory harness or schematic for the correct switch pinout.
- The parts kit provides **single-pin connectors** and **terminals** for connection to the switch.

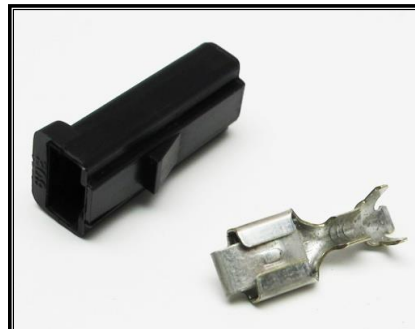

# **BRAKE SWITCH**

The location of the brake switch varies from vehicle to vehicle as this connection depends on the style of switch your vehicle uses.

A mechanical switch, like Painless part **#80172** (2-pin) or **#80176** (4-pin, also included in our torque converter lockup kits **#60109** & **#60110**), is mounted on or near the pivot point of the brake pedal. The following steps will guide you on how to connect a mechanical switch.

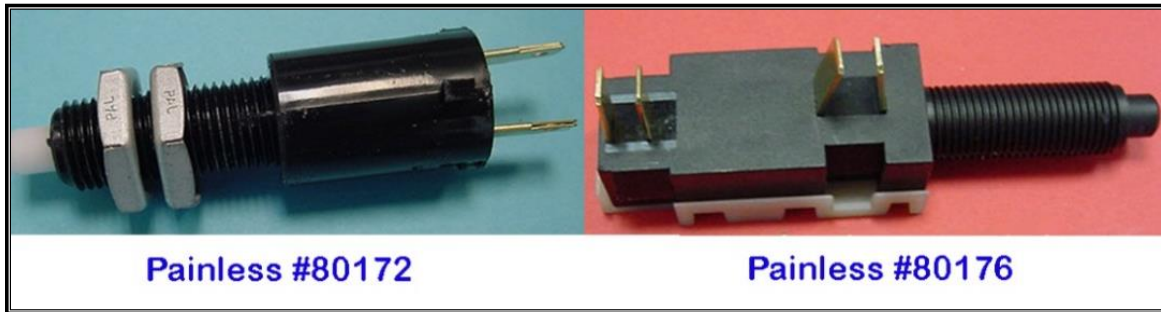

There are two wires found in the Painless chassis harness for proper brake switch connection, and they are:

**ORANGE:** 18-gauge wire, **[BRAKE SWITCH]#917 BRAKE SWITCH (BAT PWR)**; which provides power from the 20-amp STOP fuse. This wire has power at all times.

**WHITE:** 18-gauge wire, printed **[BRAKE SWITCH]#918 BRAKE SWITCH OUTPUT**; this wire supplies power from the brake switch to the brake lights. The wire goes into a splice with 2 other wires, which can be seen in the [Turn Signal Switch & Brake Switch Schematic](#) on [page 79](#).

## **2-PIN SWITCH**

- Locate the **brake switch connector** from the parts kit.
- Install the connector onto the brake switch wires.
- Plug the connector into the brake switch. Be sure to route the wires away from the moving parts of the brake pedal and/or clutch pedal.



## 4-PIN SWITCH

Two pins will have contact or will be closed when the brakes are not applied. This is usually the pair of terminals closest together. These pins are for cruise control and/or torque converter lockup.

Two pins will be separate, or open when the brakes are not applied. This is usually the pair of terminals further apart. You will need these two posts that are normally open for brake light function.



- Once you have identified the correct set of pins, connect to the switch using the **single-pin connectors** (see above).

## HARDWIRED SWITCHES



Some vehicles may have a factory, hardwired brake switch like the switch seen to the left.

- Locate the following from the parts kit:
  - (2) **1.5" 56 series single pin connector**
  - (2) **1/4" non-insulated male terminals**
  - (2) **pieces of heat shrink**
- First, remove the old terminals and/or connectors from the brake switch's wires. Then, strip **1/4"** of insulation from both wires.

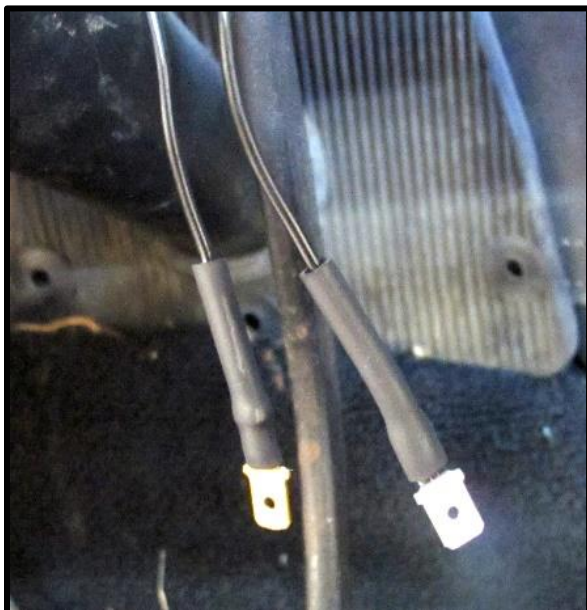

- Install the **heat shrink** and **1/4" non-insulated male terminals** on both wires.

- Install the **1.5" 56 series single pin connectors** onto the pre-terminated brake switch wires of the Painless harness.



- Finally, connect the brake switch's wires and the Painless harness wires.



# TURN SIGNAL SWITCH & BRAKE SWITCH SCHEMATIC

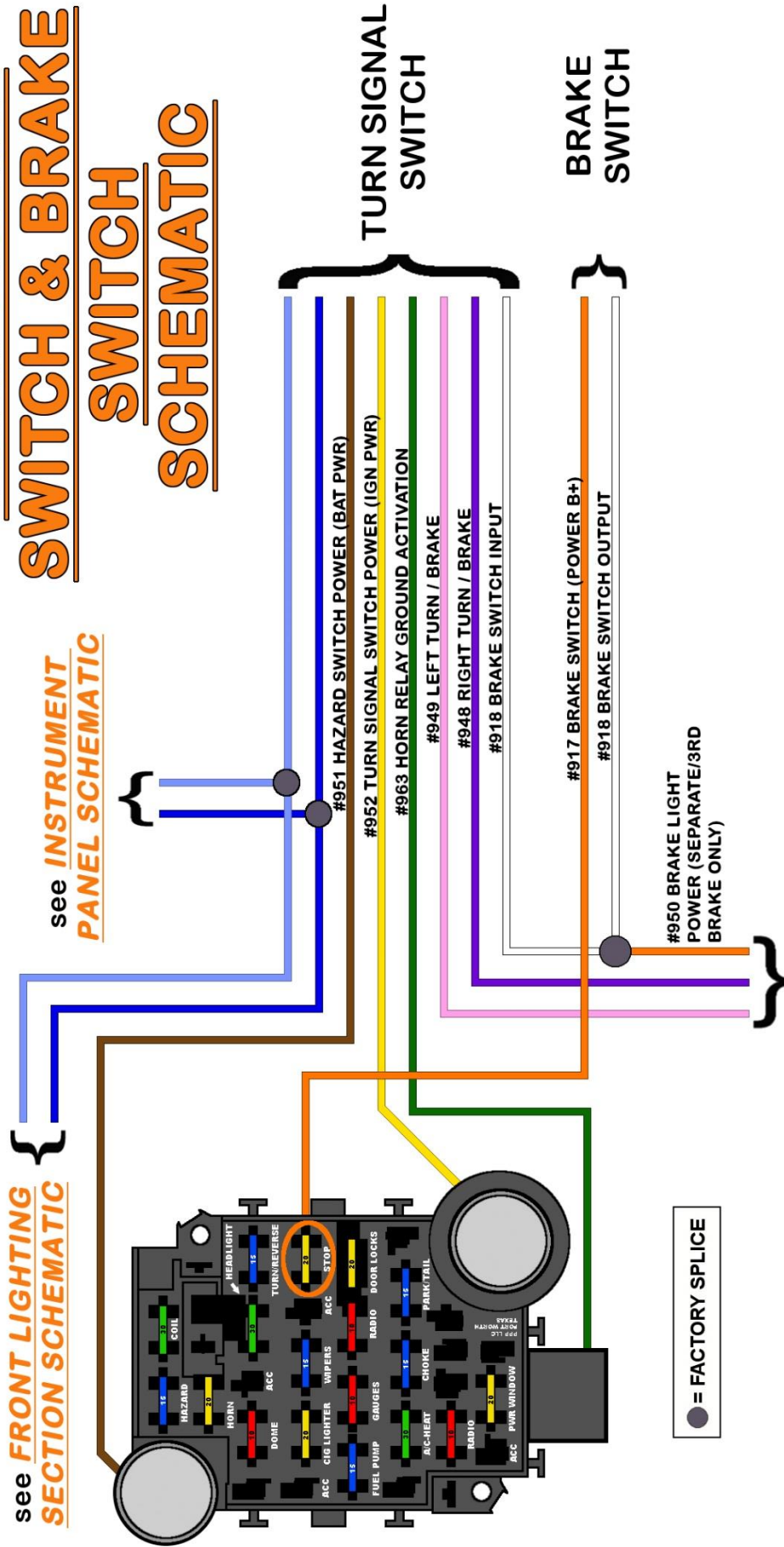



# TURN SIGNAL SWITCH

The turn signal switch provides power to each turn signal and turn signal indicator. As noted on [page 10](#), if you use LED lights, a no-load flasher is required (Painless part [#80230](#)).

In this group of instructions, you will see the term “integrated turn/brake lights.” Most vehicles have integrated lights. This terminology refers to turn signals that also function as brake lights.



The wires provided in the Painless harness for turn signal connection can be identified by the wires reading “TURN SWITCH.” These wires can be seen in the [Turn Signal Switch & Brake Switch Schematic](#) on the previous page, they are:

**LT. BLUE:** 18-gauge wire, not printed; this wire provides power to the front left turn signal. This wire has power anytime the turn signal lever is in the down/left turn position and the ignition switch is in the ON/RUN position; also, when the hazard switch is activated.

**BLUE:** 18-gauge wire, not printed; this wire provides power to the front right turn signal. This wire has power anytime the turn signal lever is in the up/right turn position and the ignition switch is in the ON/RUN position; also, when the hazard switch is activated.

**WHITE:** 18-gauge wire, printed **[TURN SWITCH] #918 BRAKE SWITCH INPUT**; this wire feeds the brake light power into the turn signal switch for vehicles with integrated turn/brake signals. This wire has power anytime the brake pedal is pressed.

**PINK:** 16-gauge wire, printed **[TAIL SECTION] #949 LEFT TURN/BRAKE**, this wire provides power to the left rear turn signal. This wire has power anytime the turn signal lever is in the down/left turn position and the ignition switch is in the ON/RUN position; also, when the hazard switch is activated. This wire also carries the power to the left brake light and has power anytime the brake pedal is pressed.

**PURPLE:** 16-gauge wire, printed **[TAIL SECTION] #948 RIGHT TURN/BRAKE**, this wire provides power to the right rear turn signal. This wire has power anytime the turn signal lever is in the up/right turn position and the ignition switch is in the ON/RUN position; also, when the hazard switch is activated. This wire also carries the power to the right brake light and has power anytime the brake pedal is pressed.

**YELLOW:** 16-gauge wire, printed, **[TURN SWITCH] #952 TURN SIGNAL SWITCH POWER (IGN PWR)**; this wire provides power to the turn signal switch. It comes from the turn signal flasher found on the fuse block. It is an ignition power wire but it has power only when the turn signal switch is activated, which causes the flasher to send power through this wire. See [Flashers](#) on [page 10](#) for how this process works.

**BROWN:** 18-gauge wire, printed, [TURN SWITCH] #951 HAZARD SWITCH POWER (BAT PWR); this wire provides power to the hazard switch. It comes from the hazard flasher found on the fuse block. It is a battery power wire but it has power only when the hazard switch is activated which causes the flasher to send power through this wire. See **Flashers** on [page 10](#) for how this process works. If you are not using a flasher this wire can be capped and stowed or removed from the harness completely along with the hazard flasher.

**GREEN:** 18-gauge wire, printed, [TURN SWITCH] #963 HORN RELAY GROUND ACTIVATION; this wire is a ground activation signal to the horn relay. The only time this wire is grounded is when the horn button on the steering wheel makes contact with a ground source.

- A new **Turn Signal Switch Connector** is provided in the parts kit. This connector was standard on the 1957 model but can be used with any standard aftermarket switch like the one shown to the right. Use the [1957 Turn Signal Switch Diagram](#) below.

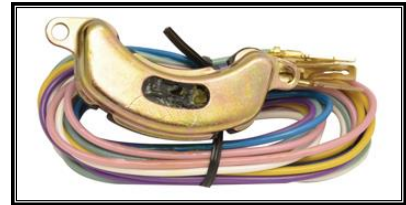

- If you have a 1956 model and wish to reuse your factory turn signal connector, the pinout is provided as well.

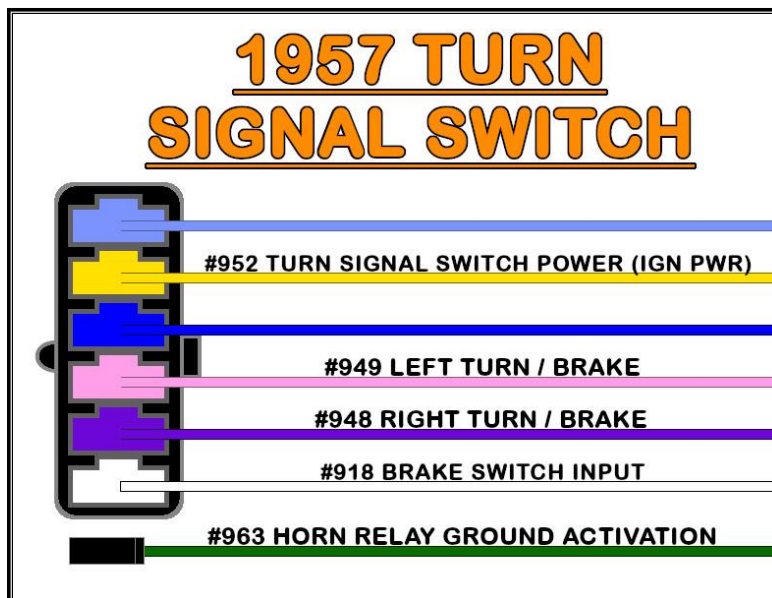
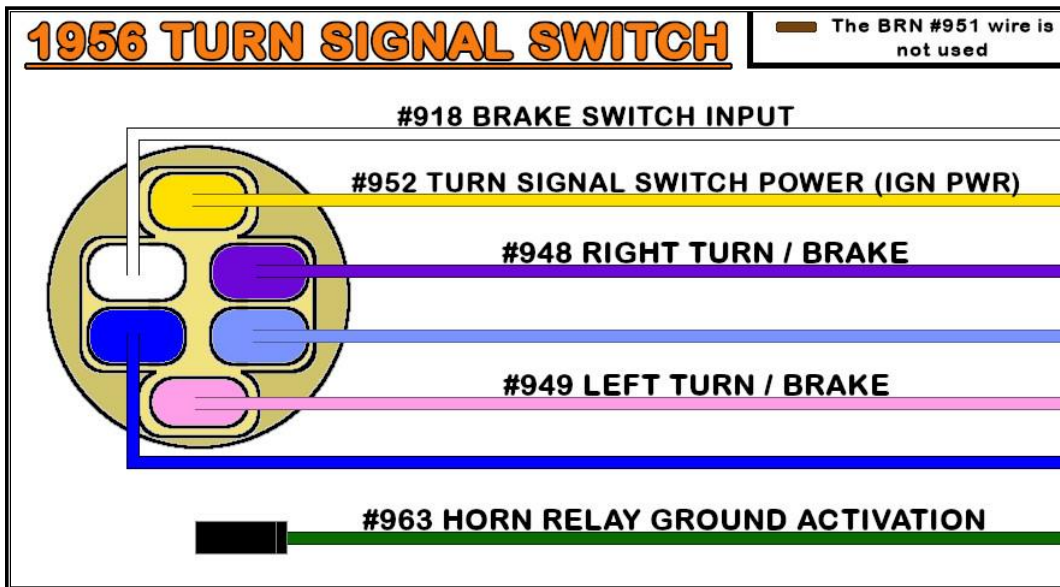

## GM COLUMNS / AFTERMARKET GM STYLE COLUMNS (Painless #30840)

- Painless kit #30840 contains the connectors and terminals seen to the right. This style connector is found on most aftermarket columns, as well as GM columns from the mid-1970s onward. These GM columns are a popular retrofit item because of their key on the column and tilt function.
- Using the diagram below, pin each wire into its correct location on the connector.
- If you use the connector, once all wires have been installed, fold the locking tab down onto the connector. It will click/snap and lock the terminals in their place.
- Connect the now installed connector onto the connector on the steering column.



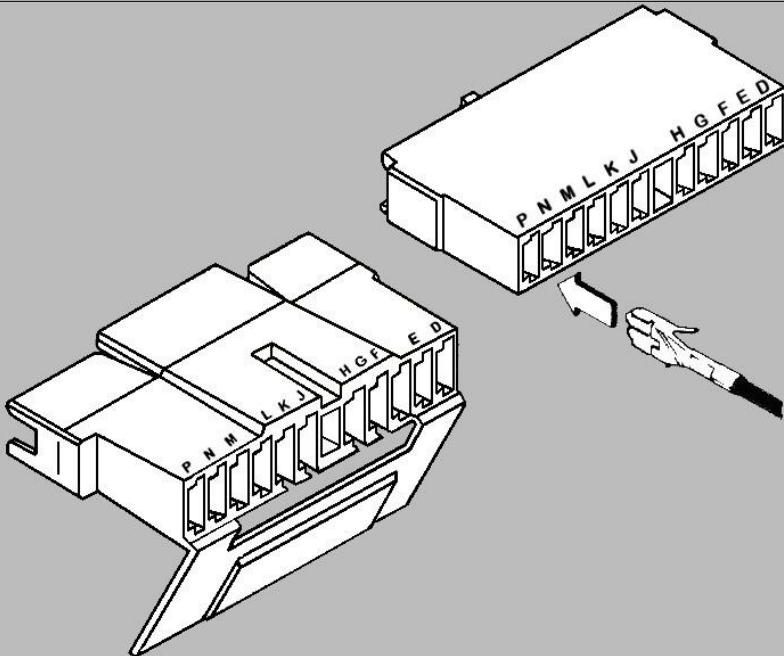

### GM TURN SIGNAL SWITCH CONNECTOR PINOUT

- D - empty**
- E - empty**
- F - empty**
- G - GRN #963** HORN ACTIVATION
- H - LT. BLU** FRT L TURN
- J - BLU** FRT R TURN
- K - BRN #951** HAZARD PWR
- L - YLW #952** TURN SIGNAL PWR
- M - PNK #949** REAR L TURN
- N - PPL #948** REAR R TURN
- P - WHT #918** BRAKE LIGHT PWR

## EXTERNAL / CLAMP-ON COLUMN MOUNTED SWITCH



There are many versions of this typical “hot rod/street rod” style switch. In most cases, this type of switch will have wires coming from it to which the chassis harness will connect. **Do not try to match the color of the wires on your switch to the colors found on the Painless harness.** Due to so many variations and manufacturers of this type of switch, a specific pinout/ schematic cannot be given for every switch. Below is a schematic with the most common way to connect one of these switches into the Painless harness. This diagram covers popular models from Grote & Speedway.

Note: The colors in the diagram reflect those found in many Grote and cheaper, aftermarket switches. However, they may not match your particular switch. Please refer to manufacturer instructions to ensure you’re connecting the proper wires.

If your clamp-on switch has an indicator light, then a 3-pin flasher is generally required. This will allow the onboard indicator lights of the switch to function properly. The Painless harness you are installing comes equipped with two 2-pin flashers which obviously will not work, and the fuse block does not have a provision for a 3-pin flasher. However, the pre-installation steps on [page 18](#) covered the initial steps on how to integrate a 3-pin flasher into the Painless system.

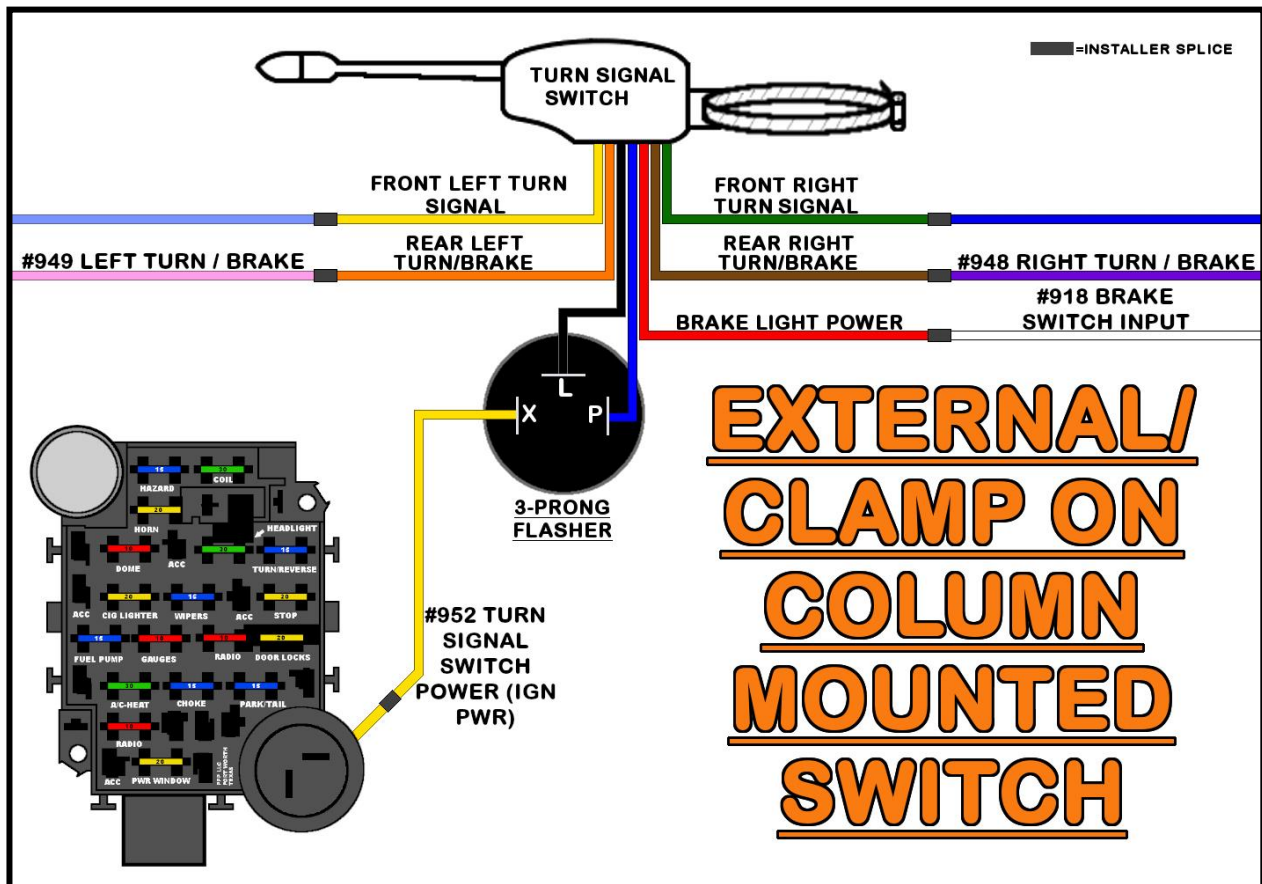

- The **YELLOW** wire from the Painless harness will provide the flasher relay with power. On most 3-pin flashers, this will be either the terminal labeled “X” or “B.”
- The other two prongs will wire to the switch wiring. The “L,” or “load” terminal will provide the load to the turn signal switch. The “P” or Pilot will go to the indicator light
- As stated before, do not try to match the switch colors to the Painless harness colors, as there are many variations in switches. Follow the manufacturers’ instructions on proper connections of the wires from the switch.

## **HAZARD SWITCH**

If you do not have a hazard switch, a 3PST On-Off switch can be used for this function.

- Connect the **BROWN** wire from the hazard flasher to all 3 poles of the switch by chaining the terminals together. This wire provides power from the flasher to the switch.
- Then, splice into the **WHITE #918**, **LT. BLUE**, & **BLUE** turn signal switch wires and connect them to the other 3 terminals. These wires connect the brake lights, as well as the front turn signals to the hazard switch.

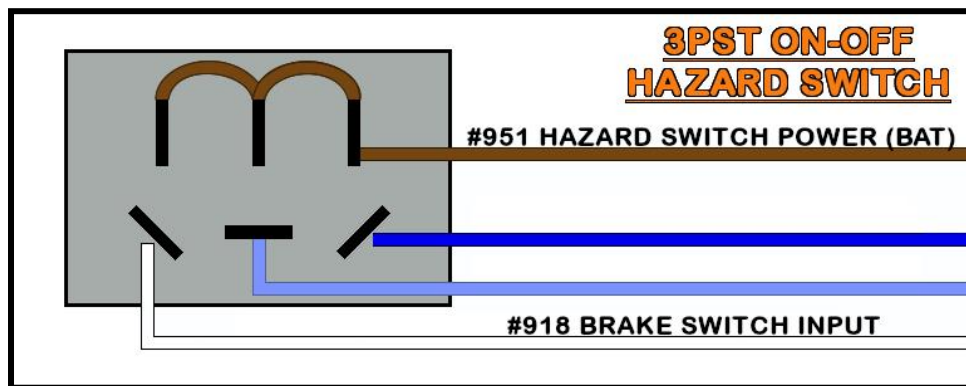

Also, a simple SPST On-Off switch can be used to flash only the brake lights in the event of an emergency. **This diagram will not flash the front turn signals like a traditional hazard flasher which your local laws may require.**

- Connect the **BROWN** power wire from the flasher to the switch. Then, run a wire from the toggle switch and splice it into the **#918** wire.

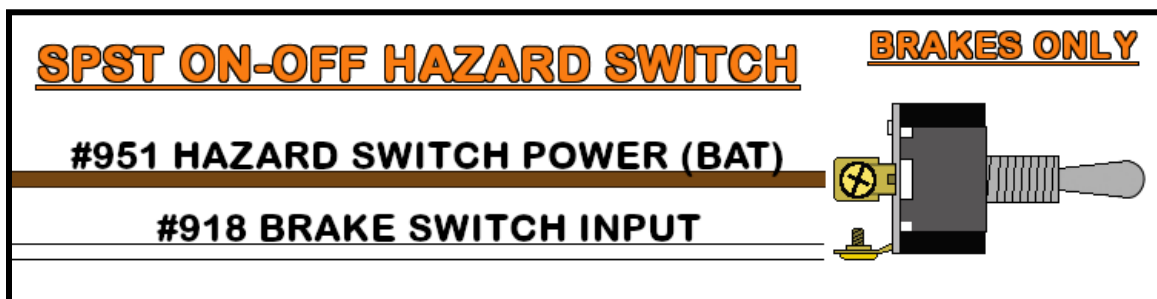

## **HORN BUTTON**

The remaining **GREEN #963** wire found in the **Turn Signal Section** will be for horn function.

- Install the **1.5" 56 series single pin connectors** onto the pre-terminated **GREEN #963** wire of the Painless harness.
- Install the **heat shrink** and **1/4" non-insulated male terminals** on the factory horn button wire if necessary.
- Connect the **GREEN #963** wire to the horn button wire.

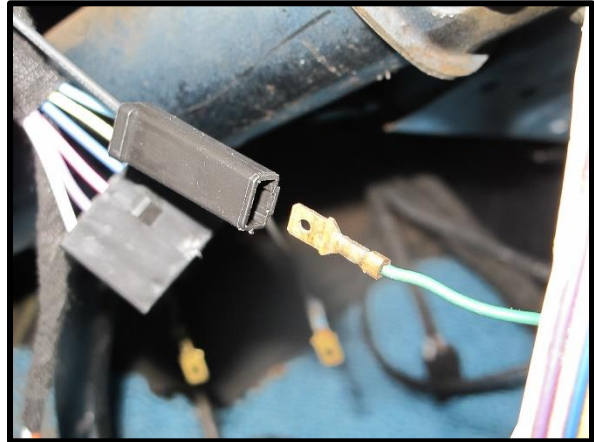

# IGNITION SWITCH

The most important connection of a wiring harness, the ignition switch, controls power to the switched ignition fuses in the fuse block as well as sending power to the starter solenoid to crank the engine.

The ignition switch connection consists of 2 sets of wires with section labels reading "IGNITION SWITCH." All wires going to the ignition switch can be seen in the [Ignition Switch Schematic](#) below.

**RED:** 12-gauge wires, printed [IGNITION SWITCH SECTION] #934 TO IGNITION SWITCH POWER (BAT PWR); this wire comes from a buss bar on the fuse block and feeds battery power to the ignition switch. This wire has power at all times.

(2) **BROWN:** 12-gauge wire, printed [IGNITION SWITCH SECTION] #933 IGN POWER TO FUSE BLOCK; these wires provide the switched power source to the fuse block. These wires power all of the switched power circuits to the harness except for the A/C-HEAT, RADIO, and PWR WINDOW fuses. This wire only has power when the ignition switch is in the ON/RUN position.

**PINK:** 12-gauge wire, printed [IGNITION SWITCH SECTION] #932 ACCESSORY POWER; this wire carries power to the A/C-HEAT, RADIO, and PWR WINDOW fuses. This wire has power when the ignition is in the ACCESSORY position and when in the ON/RUN position.

**PURPLE:** 12-gauge wire, printed [IGNITION SWITCH] #919 STARTER SOLENOID (START) [NSS]; this wire sends power to the starter solenoid or neutral safety switch and only has power when the ignition switch is in the START position.

**GREY:** 18-gauge wire, printed [IGNITION SWITCH] #930 IGN. SWITCH LIGHT POWER; this wire provides power to the ignition switch light on the 1955 & 1956 models. This wire should have constant battery power any time the headlight switch knob is pulled to both the park light ON and headlight ON positions.

**Since there are so many different types of ignition switches, chose from one of the following that best fits your application:**

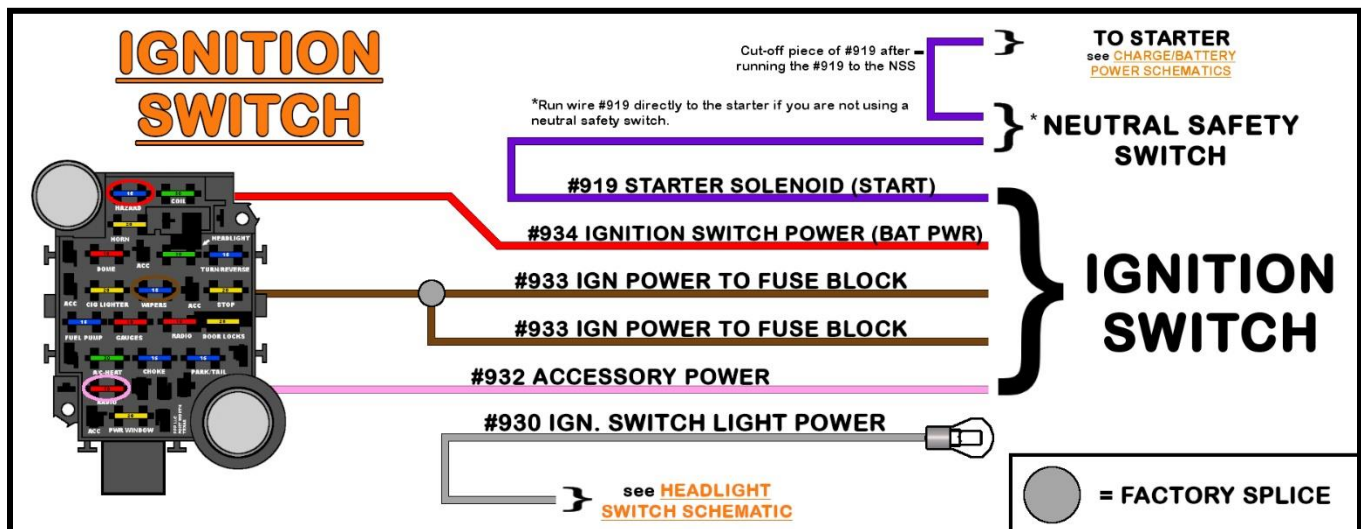

## FACTORY SWITCH – 1955 & 1956

### 55-56 IGNITION SWITCH

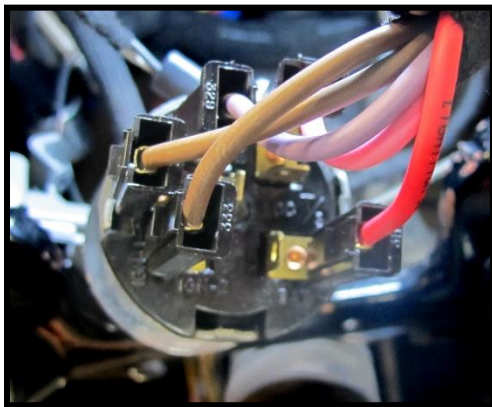
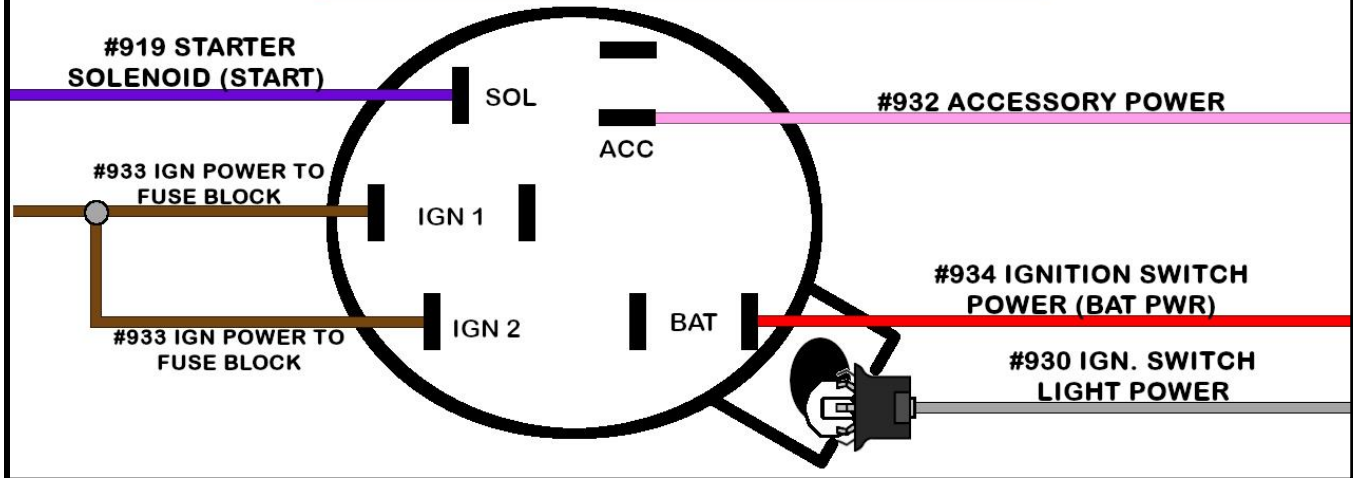

- Install **single pin 56-series connectors** onto each terminated wire and connect the ignition switch using the diagram above.

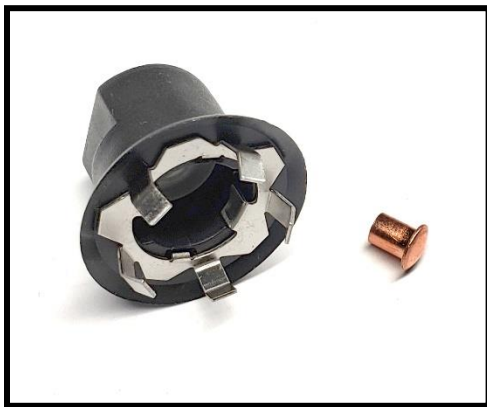

- Locate a **single-wire, uninsulated socket** from the parts kit along with a **contact** from the parts kit (see image below).
- Route the **GREY #930** wire to the ignition switch light socket, cut to length, and strip  $\frac{1}{4}$ " of insulation from the wire.
- **Slide the socket over the wire** and crimp on the **contact**.
- Install a **#1895 bulb (not provided)** into the **socket**. Finally, plug the **socket** into the ignition switch.



## FACTORY SWITCH – 1957

On the 1957 models, the **GREY #930** and one of the **BROWN #933** wires will not be used. The **BROWN #933** wire can be capped and stowed while the **GREY #930** wire can be used for a backlighting power source elsewhere.

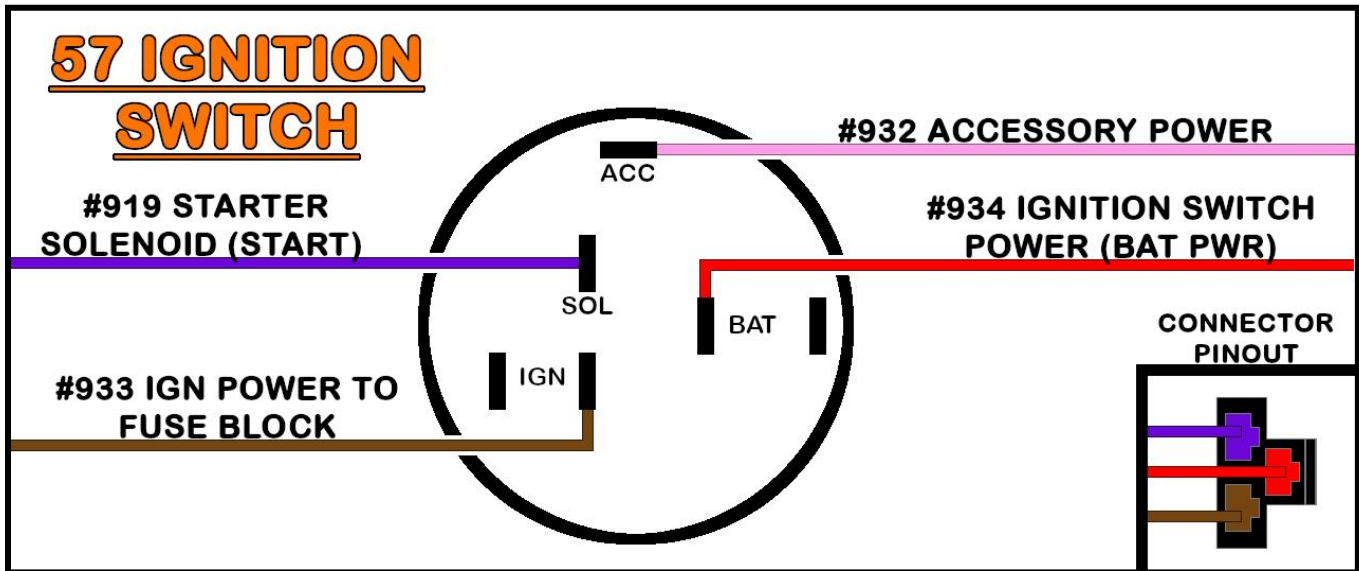

- Locate the following items in the parts kit:
  - (1) **3-way connector** – this is the same style connector most people will use to make their dimmer switch connection.
  - (1) **Single-pin 56 series connector**
- Install the **Single-pin 56 series connector** on the **PINK #932** wire.
- Plug the other three wires into the 3-way connector as shown in the diagram above. **Remember, the diagram is from the wire side.**
- Plug both connectors into the back of the ignition switch, using the pinout above.

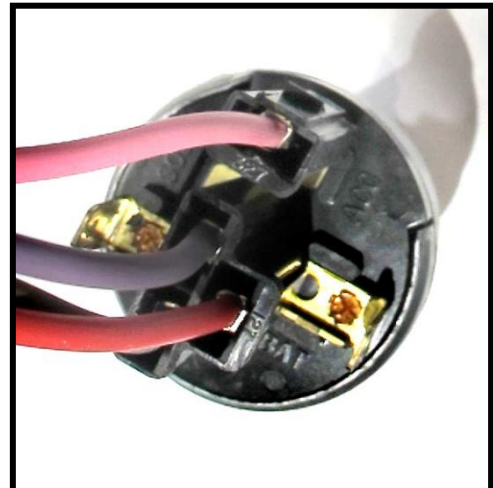

## PAINLESS UNIVERSAL IGNITION SWITCH - #80153

Painless offers a universal, dash mount ignition switch. This switch comes with the trim ring, which screws onto the switch to hold the switch in place, as well as 2 keys. The switch can be found as part **#80153** or in switch kit **#80121**.

- Use **ring terminals**, found in the parts kit, to make these connections.

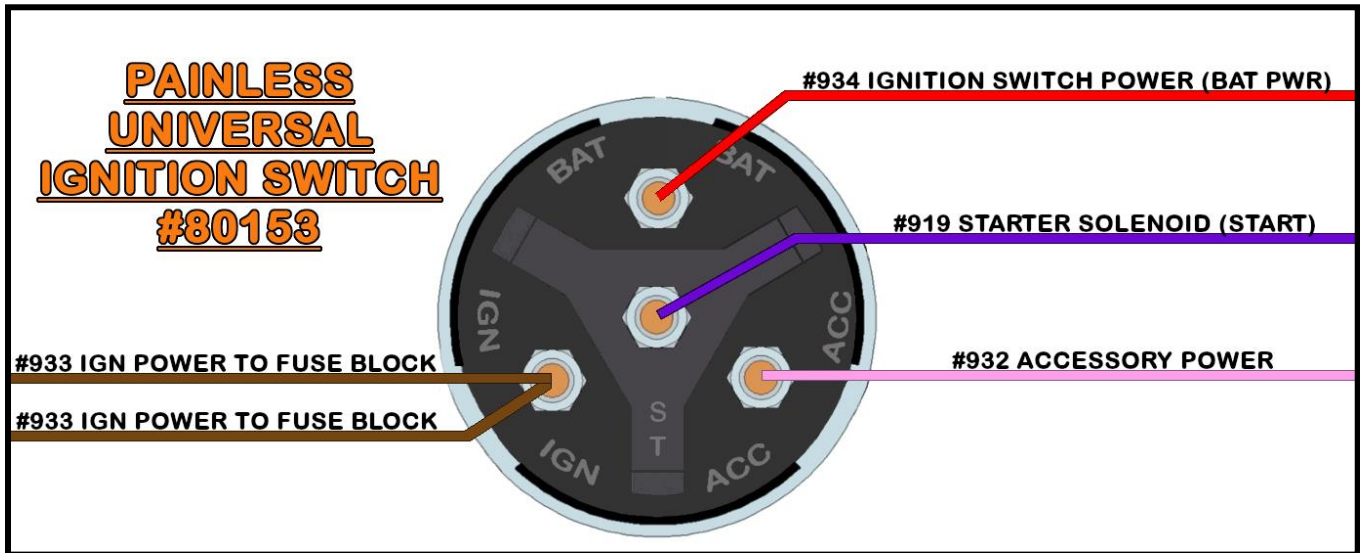

# HVAC PANEL/BLOWER SWITCH

## '55 & '56 HEATER SWITCH CONNECTIONS

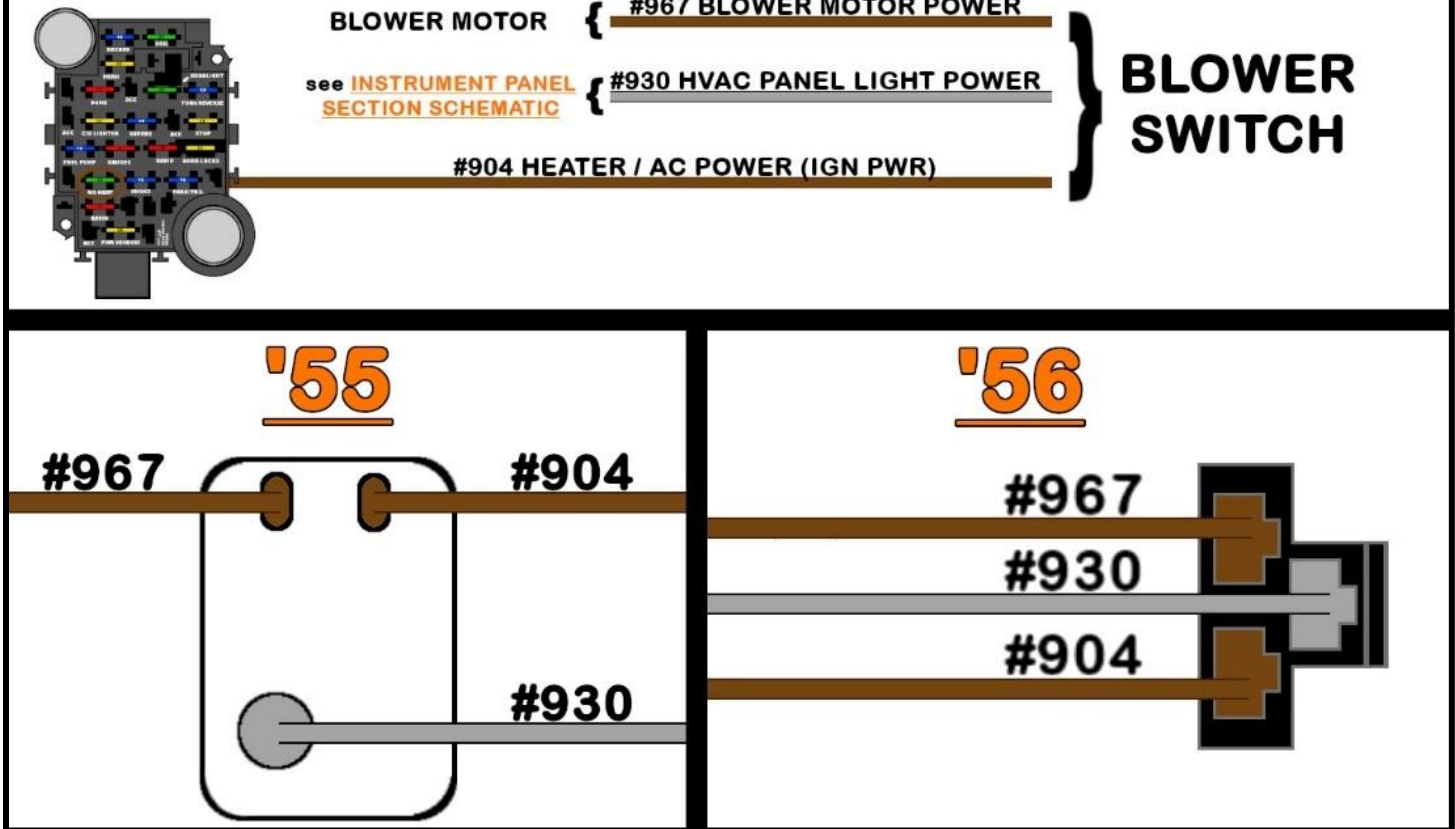

The Tri-Five blower switch connections will vary from year to year as the switches changed. However, all three years had these connections in common:

**BROWN:** 14-gauge wire, printed # [ACC. SECTION] #904 HEATER/AC POWER (IGN PWR); this wire provides the blower switch with a 30-amp, ignition switched power source from the A/C-HEAT fuse on the fuse block.

**BROWN:** 14-gauge wire, printed [ACC.SECTION] #967 BLOWER MOTOR POWER; this wire provides power to the blower motor from the blower switch.

**GREY:** 18-gauge wire, printed [ACC.SECTION] #930 HVAC PANEL LIGHT POWER; this wire provides a power source for the HVAC panel backlighting. This wire comes from the instrument panel where it doubles with the gauge backlighting wire. This wire has power anytime the headlight switch is in the Park/Tail Lights ON or Headlights ON position.

## 1955

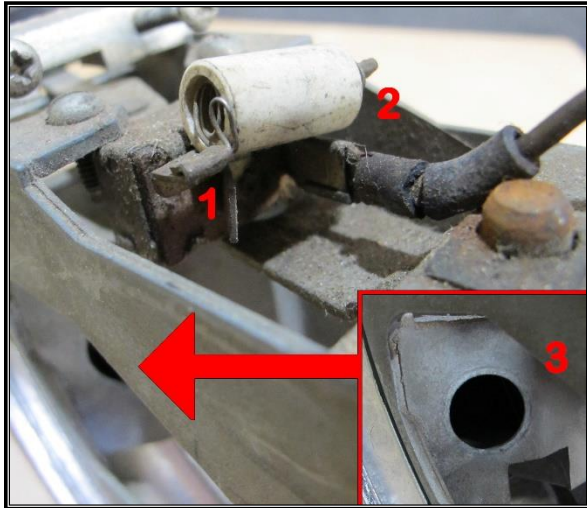

- Route the **BROWN #904** wire to the input tab of the blower switch (2), and run to length.
- Strip  $\frac{1}{4}$ " of insulation from the **BROWN #904** wire and **install a 56 series female terminal** and **heat shrink** from the parts kit onto the wire. If you are uncomfortable with a bare terminal, **insulated spade terminals** can be found in the parts kit as well.
- Connect the **BROWN #904** wire to the input terminal (2) on the blower switch.

- Repeat these steps to connect the **BROWN #967** wire to the output terminal (1) of the blower switch.



- Finally, route the **GREY #930** wire to the backlighting socket (3). If there is a power wire coming from the socket, you can splice it into the **GREY #930** wire.
- If the light socket is missing (like in the image above) or you would like to replace the old socket/wiring, an **uninsulated socket** has been provided in the parts kit. See [page 87](#) for detailed directions on connecting the provided, uninsulated lamp socket.

## 1956

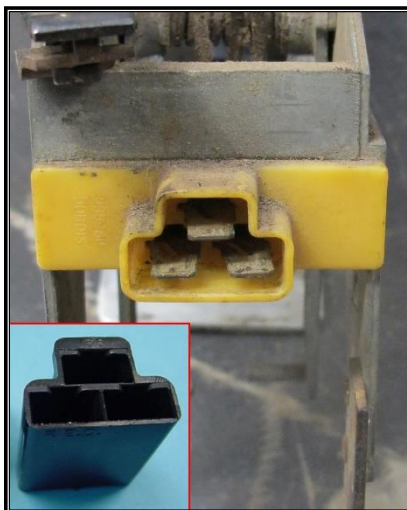

- On the back of the 1956 blower switch, there is a 3-pin connection similar to the standard GM dimmer switch. You will use the same type of terminals & connector (included) for this switch as was used in the **Dimmer Switch Section** see [page 64](#).
- Route all three wires to the blower switch connection point. Cut all three wires to length and strip  $\frac{1}{4}$ " of insulation from each.
- Install the terminals and connector using the diagram on the previous page. Remember connections are shown from the wire side.

## 1957

The 1957 blower switch had five wires coming from it that lead to a connector that is mounted to the HVAC panel. (see Heater Switch Conn. in the diagram on the next page). Most aftermarket switches come with these five wires hardwired to the switch with male terminals pre-installed. Therefore, Painless has provided you with a new **heater switch connector** (see right).

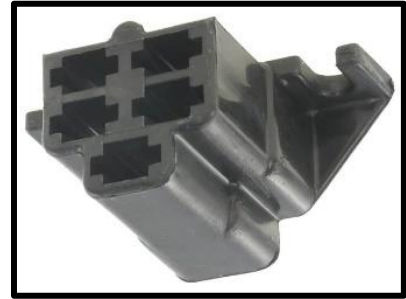

- Plug the wires of your blower switch into the new connector using the diagram on the next page. This step is optional as you can re-use your old connector if you wish.

- (Re)mount the Heater Switch Connector to the HVAC panel.

- Next, locate the **'57 Heater Switch Pigtail** from the parts kit. This pigtail plugs into the **Heater Switch Connector** and contains the signal wires that run between the blower switch and resistor. They are:

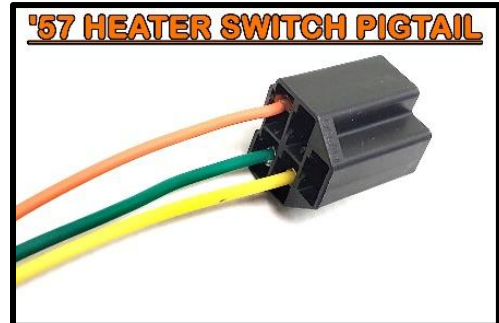

**YELLOW:** 14-gauge wire, printed **[ACC. SECTION] #975 BLOWER MOTOR LOW**; this wire provides the blower switch with a 30-amp, ignition switched power source from the A/C-HEAT fuse on the fuse block.

**GREEN:** 14-gauge wire, printed **[ACC. SECTION] #974 BLOWER MOTOR MEDIUM**; this wire will have a single-pin black connector pre-installed. This wire will provide power to the blower motor from the blower switch.

**ORANGE:** 14-gauge wire, printed **[ACC. SECTION] #973 BLOWER MOTOR HIGH**; this wire will have a single pin black connector pre-installed. This wire will provide power to the blower motor from the blower switch.

- Route the **BROWN #904** and **GREY #930** to where the Heater Switch Connector is mounted and cut to length.
- Strip  $\frac{1}{4}$ " of insulation from both wires, **install 56 series female terminals** from the parts kit and plug the wires into the **Heater Switch Pigtail connector** using the pinout below. Then plug the pigtail into the **Heater Switch Connector**.

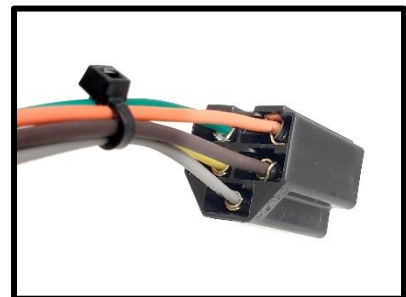

The connection to the resistor will vary depending on your resistor. From the factory the vehicle was equipped with a 4-pin resistor, however, most aftermarket resistors are only 3 pins.

# '57 HEATER SWITCH & RESISTOR CONNECTORS

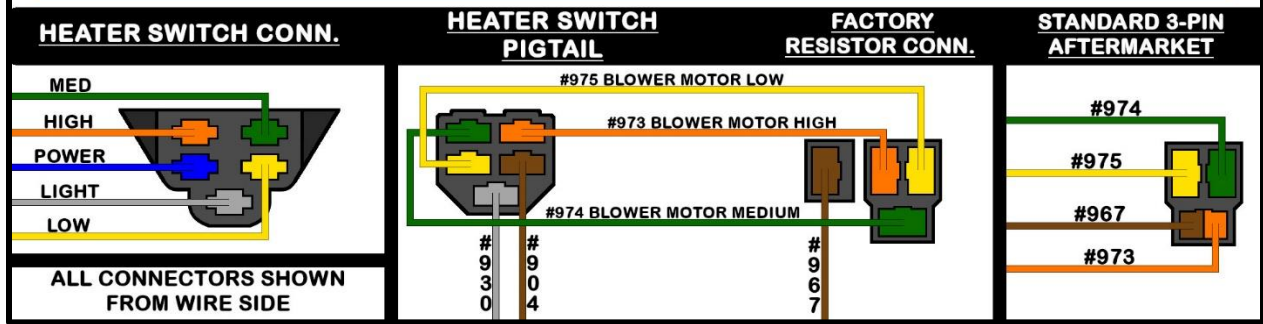

Route the **BROWN #967**, **YELLOW #975**, **GREEN #974**, and **ORANGE #973** wires to the resistor, cut to length, and strip  $\frac{1}{4}$ " of insulation from each wire.

- Attach **14-16ga. 56 series female terminals** from the kit to each wire. If you're using a 3-pin resistor, the **BROWN #967** and **ORANGE #973** wires will double with each other. This will require a **10ga. 56 series terminal** from the parts kit

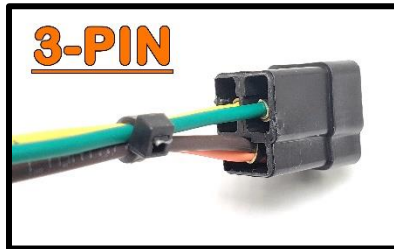

- Install the newly terminated wires into the provided connectors using the pinout above.

**NOTE: The aftermarket resistor pinout above may not reflect your resistor. Please check the manufacturer's diagram before making these connections.**

## AFTERMARKET SYSTEMS

- Your aftermarket A/C system will have a separate harness that the wires of the Painless harness will connect to. Since these systems have their own harness, the **BROWN #967** wire will typically not be used and can be removed.
- Connect the **BROWN #904** and to the wire(s) of your aftermarket A/C system harness that requires a fused, 12v power source (some systems will have more than one).
- Some aftermarket A/C systems provide the installer with an inline circuit breaker between the 12v power source and the blower relay. Since the **#904** wire is coming from the 30-amp AC/HEAT fuse, the circuit breaker is no longer necessary.
- Locate the backlighting wire of the A/C harness and connect it to **GREY #930** wire.

# A/C SYSTEM W/ TRINARY SAFETY SWITCH

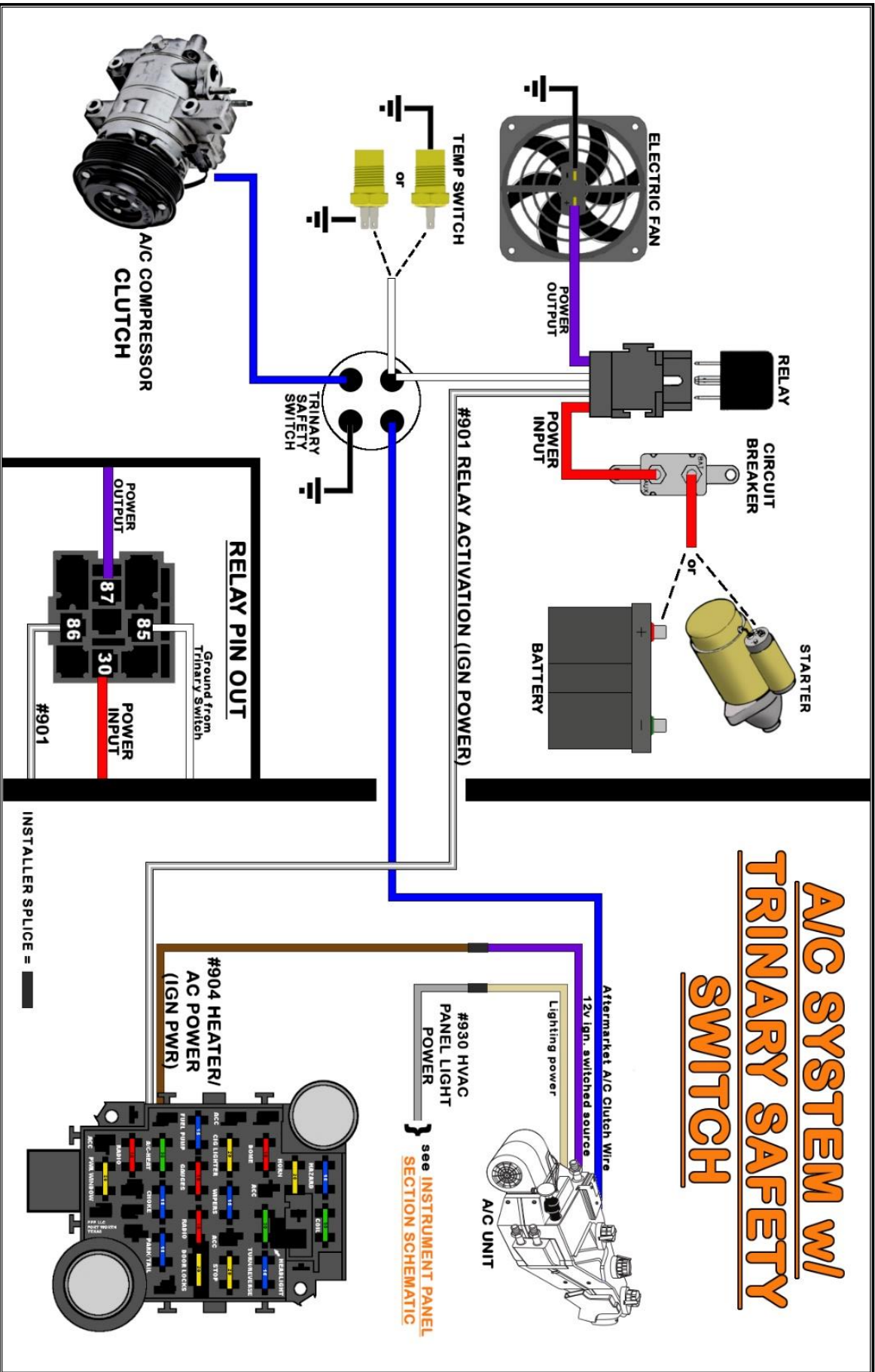

# REVERSE SWITCH

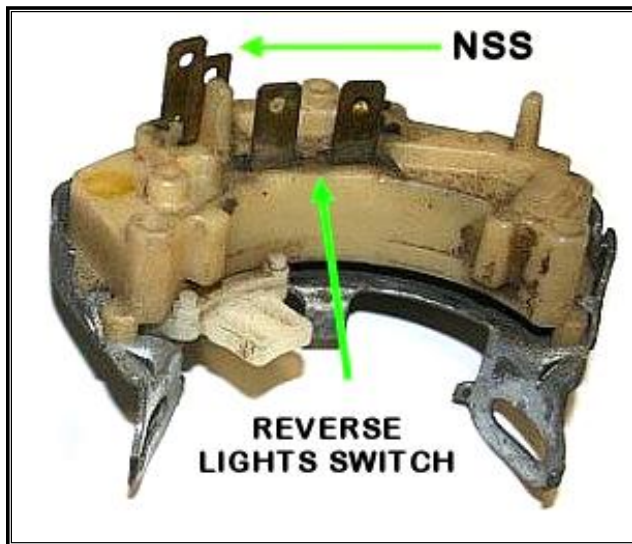

The reverse switch connection provides the backup lights the power they need to illuminate. This switch is a 2-pin, normally open switch that has power coming into one side and out the other to the backup lights. When the shifter is put into the reverse position, contact is made between these 2 pins, closing the switch. This allows power to flow from one pin to another, thus transferring power through the switch out to the backup lamps. The 2 wires provided for this option are:

**PINK:** 18-gauge wire, printed **[REVERSE SWITCH] #958 REVERSE SWITCH POWER (IGN PWR)**; this wire comes from the 15-amp TURN/REVERSE fuse on the fuse block. This wire is a switched ignition power wire meaning it will only have power when the ignition switch is in the ACCESSORY and ON/RUN positions.

If you do not have backup lights, **#958** can be used to power an accessory requiring a switched 12v power source.

**LT. GREEN:** 18-gauge wire, printed **[REVERSE SWITCH] #956 OUTPUT TO REVERSE LIGHTS**; this wire provides power from the reverse switch to the backup lights in the **Tail Section** of the Painless harness.

- Locate the reverse switch; the location varies from vehicle to vehicle.

Many of those using a GM-style column can find the reverse switch (see image above) at the base of the steering column. This same switch can be found at the base of some console shifters.

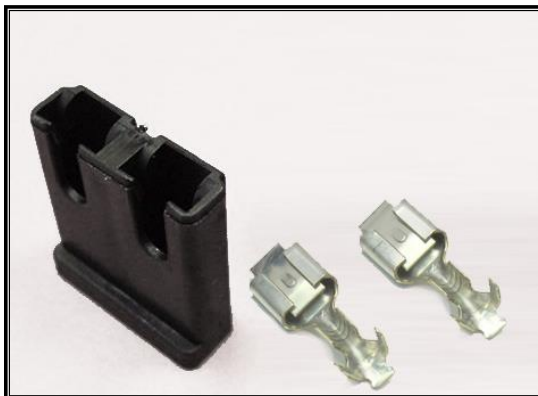

- Route the wires to the reverse switch, cut to length, and strip  $\frac{1}{4}$ " of insulation.
- A connector and terminals are provided for those with the late-model factory reverse switch seen above. It does not matter which tab each wire connects to.



- If you are using an aftermarket floor-mounted shifter, the reverse switch may be found on the base of the shifter. There may also be a neutral safety switch found on the shifter as well. When testing the system, if you notice the reverse lights on when the transmission is in park or neutral, you have the reverse switch wires connected to the neutral safety switch.

Small insulated terminals have been provided in the parts kit to accommodate aftermarket shifter switches.

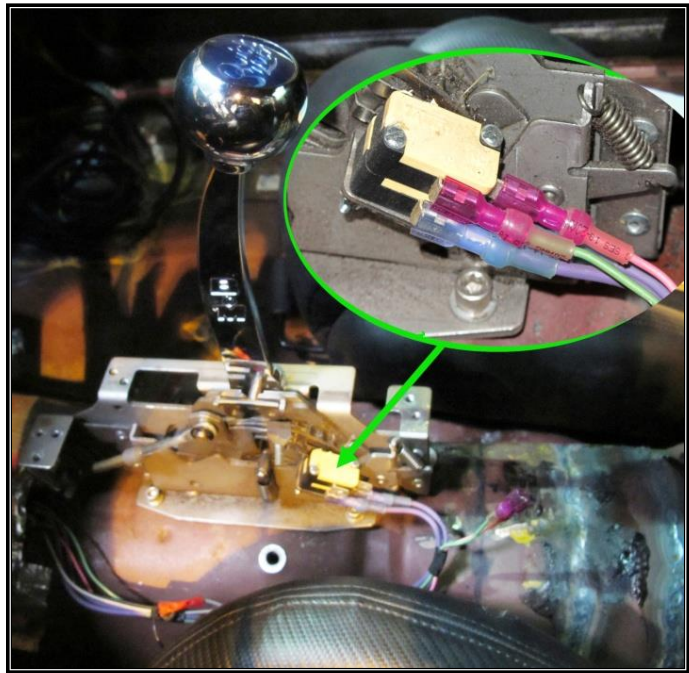

- Painless offers [part #80175](#) for those using GM TH350, TH400, 700-R4, TH200, 200-4R, & 4L60 transmissions. This part can be used as either a reverse switch or a neutral safety switch.

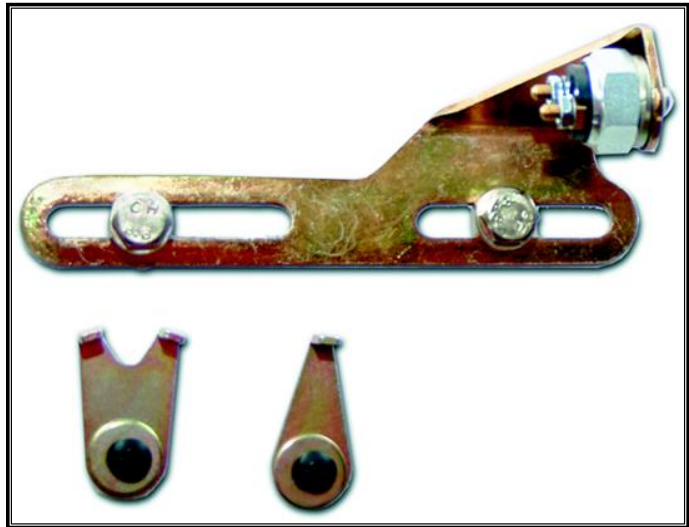

## 4L60E/4L80E SWITCH

The 4L60e/4L80e transmission, from trucks or SUVs, has a factory reverse switch on the shift detent rod on the driver's side of the transmission. This same switch also has a park/neutral switch incorporated. Use the diagrams below to connect the reverse wires of the Painless harness to this switch.

For those with a 4L60e/4L80e transmission, a starter relay must be used (not supplied) unless you use a factory switch on a GM Keyed column. The switch is not capable of handling the amperage the solenoid requires.

The following section of this manual, Neutral Safety/Clutch Switch, contains information on the starter relay shown in the diagrams. The wires of the Painless harness will need to splice to the existing wires coming from your switch connector

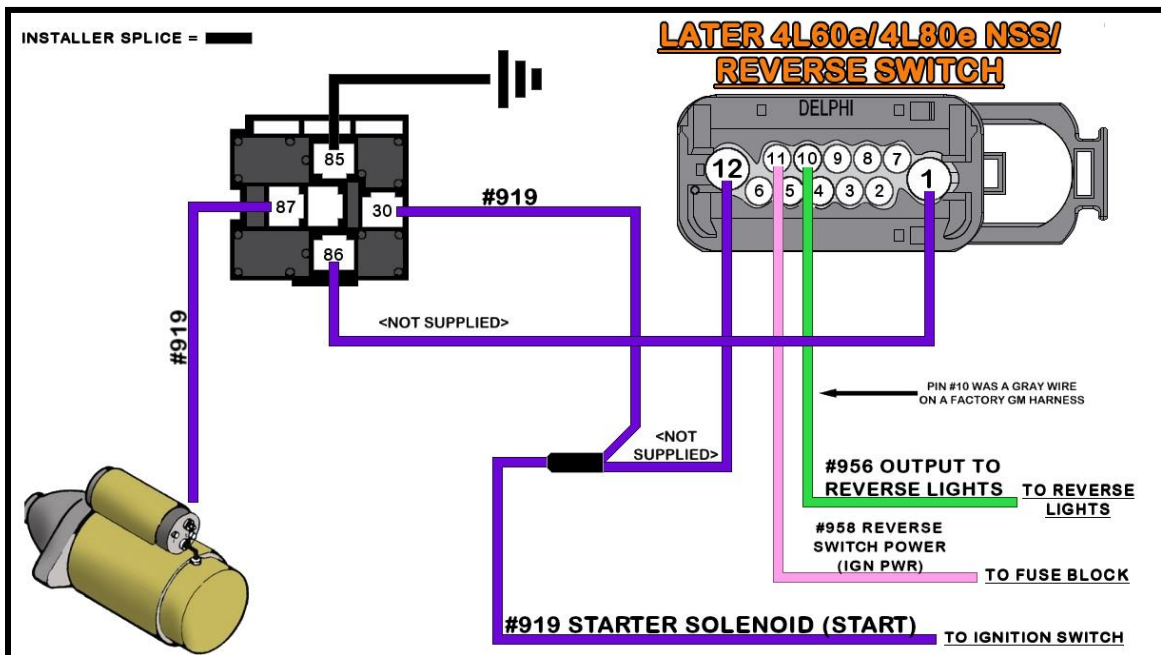
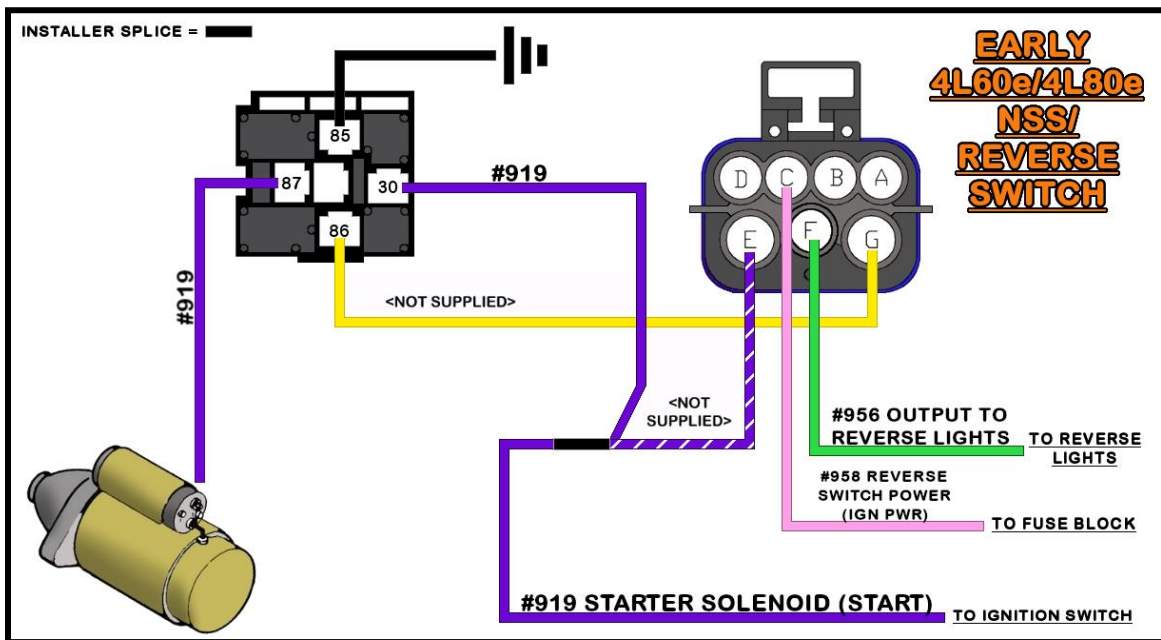

# NEUTRAL SAFETY / CLUTCH SWITCH

This switch is a safety device that prevents the vehicle from being started while in gear and causing an unfortunate accident. The purpose of this switch is to only allow the engine to be started when the vehicle is in park or neutral (automatic transmissions) or if the clutch pedal is depressed (manual transmissions). When the transmission is put into park/neutral or the clutch pedal is depressed, contact is made between these two pins, closing the switch. This allows power to flow from one pin to another, transferring power through the switch to the starter solenoid.



The neutral safety/clutch switch connection will involve one wire coming from the ignition switch, it is:

**PURPLE:** 12-gauge wire, printed **[IGNITION SWITCH] #919 STARTER SOLENOID (START) [NSS]**; This wire comes from the ignition switch and only has power when the switch is in the START position. This wire provides power to the neutral safety switch (NSS) from the ignition switch. **Once the wire is routed and cut, the excess wire is used to provide power from the NSS to the starter solenoid "S" terminal.** This wire can be seen in the [Charge / Battery Power Schematic](#) on [page 52](#) and the various ignition switch schematics found on [pages 87 – 89](#).

- If you have an automatic transmission with a column shift, the NSS is usually located at the base of the steering column, as seen in the photo with the reverse switch on [page 95](#). This same switch can be found at the base of some console shifters.
- Route the wire to the switch, cut to length, strip  $\frac{1}{4}$ " of insulation, and connect.
- Then, strip  $\frac{1}{4}$ " of insulation from the cutoff piece of **PURPLE #919** wire and connect it to the other side of the NSS using the provided **connector** and **terminals**.
- Once connected to the switch, route the cutoff portion of **#919** to the "S" terminal on the Starter and connect (see [page 63](#)). This cut-off wire will then provide power from the NSS from the starter solenoid.



## **CLUTCH SWITCH**

- If you have a manual, the clutch switch is located at the top of the clutch pedal, much like the brake switch on the brake pedal.
- Route the wires to the switch, cut to length, and strip  $\frac{1}{4}$ " of insulation. Also, strip  $\frac{1}{4}$ " of insulation from the cutoff piece of **PURPLE #919** wire as it will connect to the switch as well.
- Use the **2-pin connector** (seen on the previous page) from the parts kit or **(2) single-pin 56 series connectors** and **(2) terminals** to make the connection. It does not matter which tab each wire connects to. Once connected to the switch, route the cutoff portion of **#919** to the "S" terminal on the Starter and connect as mentioned on previously.
- For those with a 4L60e/4L80e transmission, a starter relay must be used (not supplied) if using a factory switch; as shown on **page 97**. The switch is not capable of handling the amperage the solenoid requires.
- Like with the 4L60e/4L80e transmission, if you have a transmission mounted NNS that you are accessing through the engine compartment, this wire should have been rerouted to the **Engine Section**. From there, route the **PURPLE #919** wire to the NSS, cut to length, and connect. Use the cut-off portion of the **PURPLE #919** wire to connect the NSS to the "S" terminal on the starter solenoid.

**If you do not have a neutral safety/clutch switch and do not plan on getting one, route the #919 wire directly to the Starter Solenoid "S" Terminal.**

**Painless does not recommend operating your vehicle without a neutral safety/clutch switch.**

### **NOTES:**

# DASH GROUND

Four sections of the interior harness have ground wires. Of course, all these wires must be grounded to the chassis. To do this, the four wires have been spliced to a single wire that will ground to the dash support behind the instrument panel. This wire is:

**BLACK:** 14-gauge wire, printed **#969 TO CHASSIS GROUND**; this wire provides a ground source to the interior sections of the harness.

- Route the **BLACK #969** wire to an appropriate chassis ground source. Again, Painless recommends the bolt of one of the dash supports as seen above.
- Cut the wire to length, strip  $\frac{1}{4}$ " of insulation, and attach the  $\frac{5}{16}$ " **uninsulated ring terminal** and **heat-shrink** from the parts kit. Star-washers are recommended, especially in painted areas, to help bite through to the bare metal.



## GROUND SPLICE LAYOUT

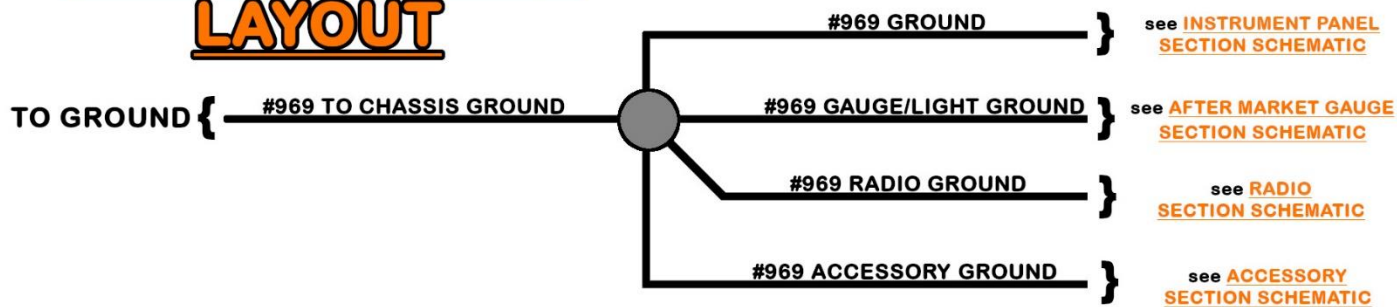

# INSTRUMENT PANEL

The instrument panel connections of the Painless harness vary according to the gauge cluster or aftermarket gauges you are using. The wires of the main harness end in a connector. In the kit, there are two different cluster harnesses that can plug into this connector. Which harness you use will depend on if you're using a factory gauge cluster or an aftermarket cluster. The main harness wires are:

**BROWN/WHITE:** 18-gauge wire, printed **[INSTRUMENT PANEL] #914 ALT/GEN LIGHT POWER (IGN PWR)**; this wire provides power to the alternator/ generator light on the instrument panel. This wire comes from the 20-amp PWR WINDOW fuse and has power when the ignition is in the ACCESSORY position and when in the ON/RUN position.

**BROWN/WHITE:** 18-gauge wire, printed **[ALTERNATOR] #914 REGULATOR POWER (IGN PWR) [INSTRUMENT PANEL]**; this is the regulator power wire and has switched ignition power from the fuse block through the alt/gen light on the instrument panel. This wire comes from the 20-amp PWR WINDOW fuse and has power when the ignition is in the ACCESSORY position and when in the ON/RUN position.

These wires at the instrument panel control the gen./alt. light and function like so: The electrical current moving from the fuse block, through the filament, and out to the alternator causes the light to illuminate. This light illuminates when the key is in the ON/RUN position and the alternator is not charging because the engine is not running or when the alternator is not working properly. Once the alternator is charging, the voltage regulator no longer needs the switched ignition voltage supplied by the #914 wire, which stops the current flow. Since power is no longer flowing through the filament, the bulb does not illuminate.

**LT. GREEN:** 18-gauge wire, printed **[INSTRUMENT PANEL SECTION] #936 HIGH BEAM INDICATOR**; this wire provides power to the high beam indicator when the headlight switch is in the "ON" position and the dimmer switch is in the "HIGH" position.

**LT. BLUE:** 18-gauge wire, printed **[INSTRUMENT PANEL] #937 LEFT TURN INDICATOR**; this wire provides power to the left turn indicator when the turn signal switch is in the left turn position.

**BLUE:** 18-gauge wire, printed **[INSTRUMENT PANEL] #938 RIGHT TURN INDICATOR**; this wire provides power to the right turn indicator when the turn signal switch is in the right turn position.

**PINK:** 18-gauge wire, printed **[INSTRUMENT PANEL] #935 GAUGE POWER (IGN PWR)**; this wire provides a switched ignition power source to the cluster. This wire comes from the 10-amp GAUGES fuse on the fuse block. This wire has power anytime the key is in the ON/RUN position.

**GREEN:** 18-gauge wire, printed **[ENGINE SECTION] #921 COOLANT TEMP SIGNAL [INSTRUMENT PANEL]**; this wire is a ground signal from the engine coolant temperature sending unit. The sending unit will create resistance to ground according to engine temperature. This resistance is transferred through this wire to the gauge. This wire is doubled with another **GREEN #921** wire that sends a signal to the Aftermarket Dash-Mounted Gauge Section. See [page 111](#).

**LT. BLUE/BLACK:** 18-gauge wire, printed **[ENGINE SECTION] #922 OIL PRESSURE SIGNAL [INSTRUMENT PANEL]**; this wire is a ground signal from the oil pressure sending unit. The sending unit will create resistance to ground according to oil pressure. This resistance is transferred through this wire to the gauge. This wire is doubled with another **LT. BLUE/BLACK #922** wire that sends a signal to the **Aftermarket Dash-Mounted Gauge Section**. See [page 111](#).

**GREEN/WHITE:** 18-gauge wire, printed **[ENGINE SECTION] #923 TACHOMETER SIGNAL [INSTRUMENT PANEL]**; this wire is a ground signal from the negative side of the ignition coil. This wire can also be seen in the coil connection diagrams on [pages 49 & 50](#). This wire is doubled with another **GREEN/WHITE #923** wire that sends a signal to the **Aftermarket Dash-Mounted Gauge Section**. See [page 111](#).

**GREY:** 18-gauge wire, not printed; this wire provides a power source for gauge backlighting. This wire comes from the headlight switch and has power anytime the headlight switch is in the Park/Tail Lights ON or Headlights ON position. This wire can also be seen in the [Headlight Switch & Dimmer Switch Schematic](#) on [page 71](#). This wire can also be seen in the coil connection diagrams on [pages 49 & 50](#). This wire is doubled with another **GREY #930** wire that provides the backlighting power source for the HVAC panel. See [Heater Switch Connections Schematic](#) on [pages 90 & 93](#).

**BROWN:** 18-gauge wire, printed **[TAIL SECTION] #939 FUEL LEVEL SIGNAL [INSTRUMENT PANEL]**; this wire is a ground signal from the fuel level sending unit in the fuel tank. The resistance to ground will vary on this wire according to the amount of fuel in the tank. This wire can also be seen in the [Tail Section Schematics](#) on [page 129](#).

**RED:** 18-gauge wire, not printed; this wire provides a constant battery power source to an aftermarket gauge controller. This wire comes from the 20-amp CIG LIGHTER fuse on the fuse block. This wire will have power anytime the key is in the ON/RUN position.

**BLACK:** 18-gauge wire, printed **[INSTRUMENT PANEL] #969 GROUND**; this wire provides a ground source to the instrument panel and is tied to the ground splice discussed in the previous section (see [Ground Splice Schematic](#) on [page 100](#)).

# INSTRUMENT PANEL

## MAIN HARNESS CONNECTOR

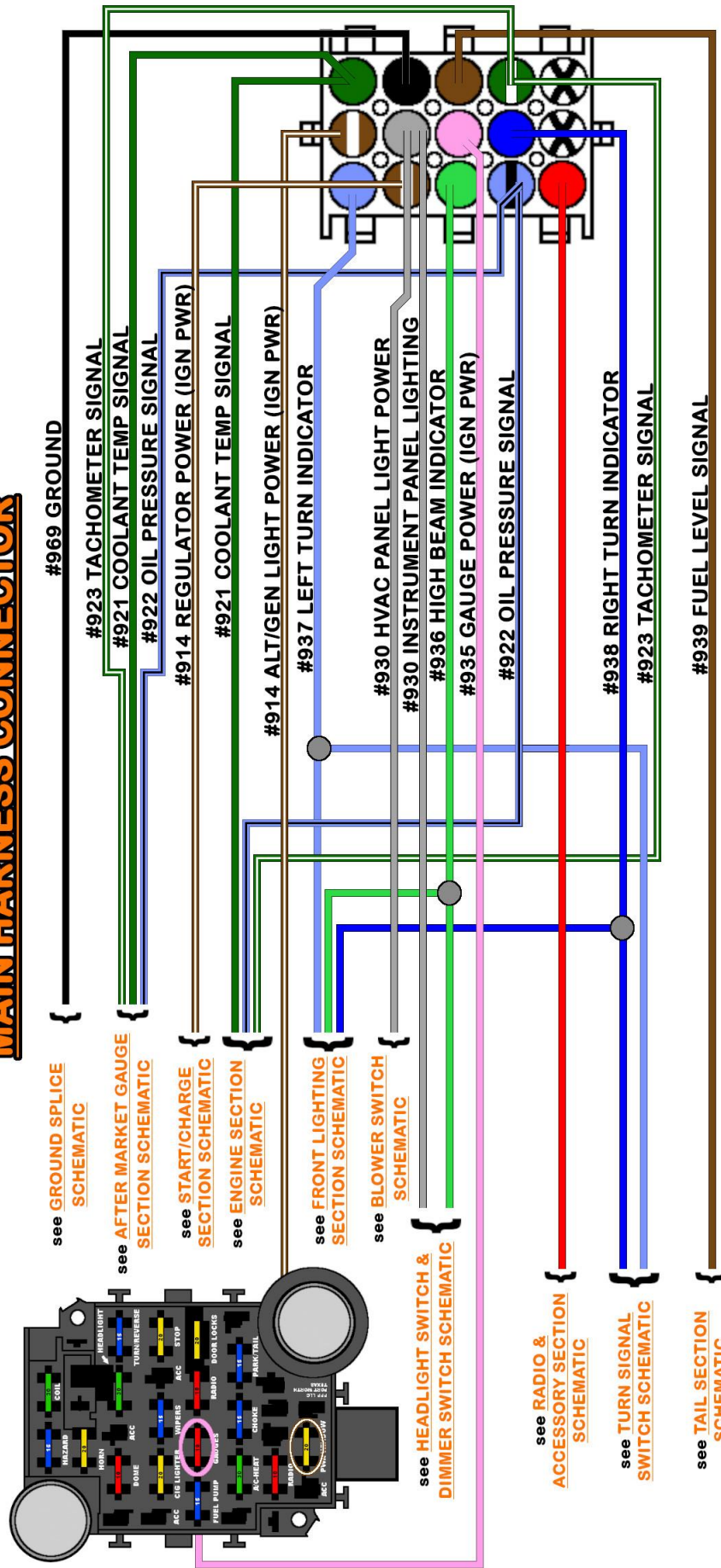



## **FACTORY GAUGES**

- The **Factory Cluster Harness** comes ready to plug in without modification. Use the diagrams on the next page to make your connections.
- **\*Note:** The sockets take 1895 series bulbs (**not included**).
- **1957 ONLY:** The coolant temp and fuel level wires must have their terminals changed to the provided red bullet terminals.
- Zip-ties from the parts kit can help clean up the install once all the wires are routed.
- After the cluster harness is installed on the cluster, plug the cluster harness into the main harness.
- Do not forget to attach the ground wire.

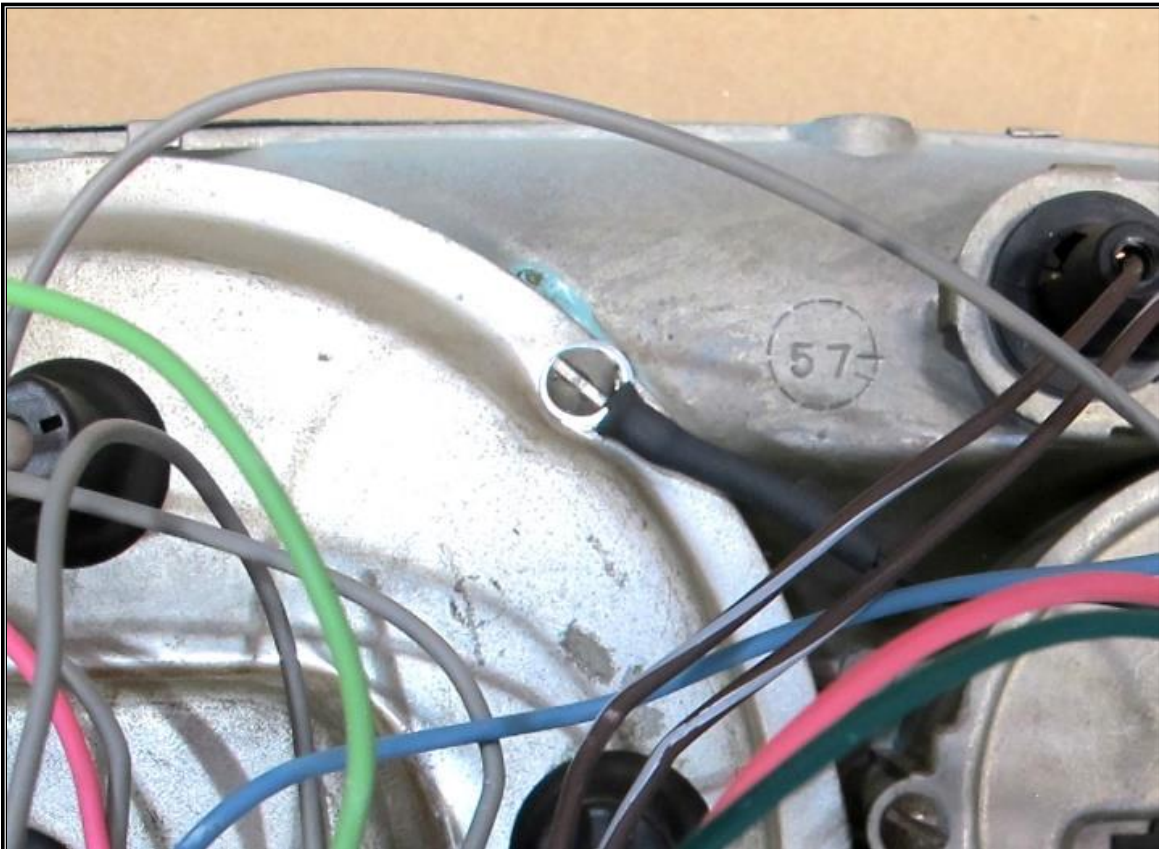
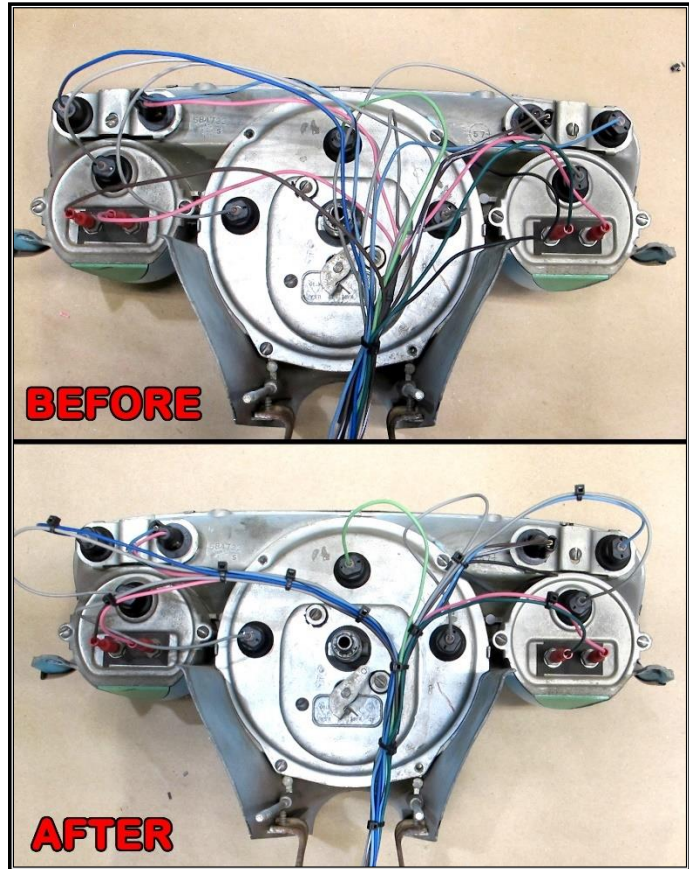

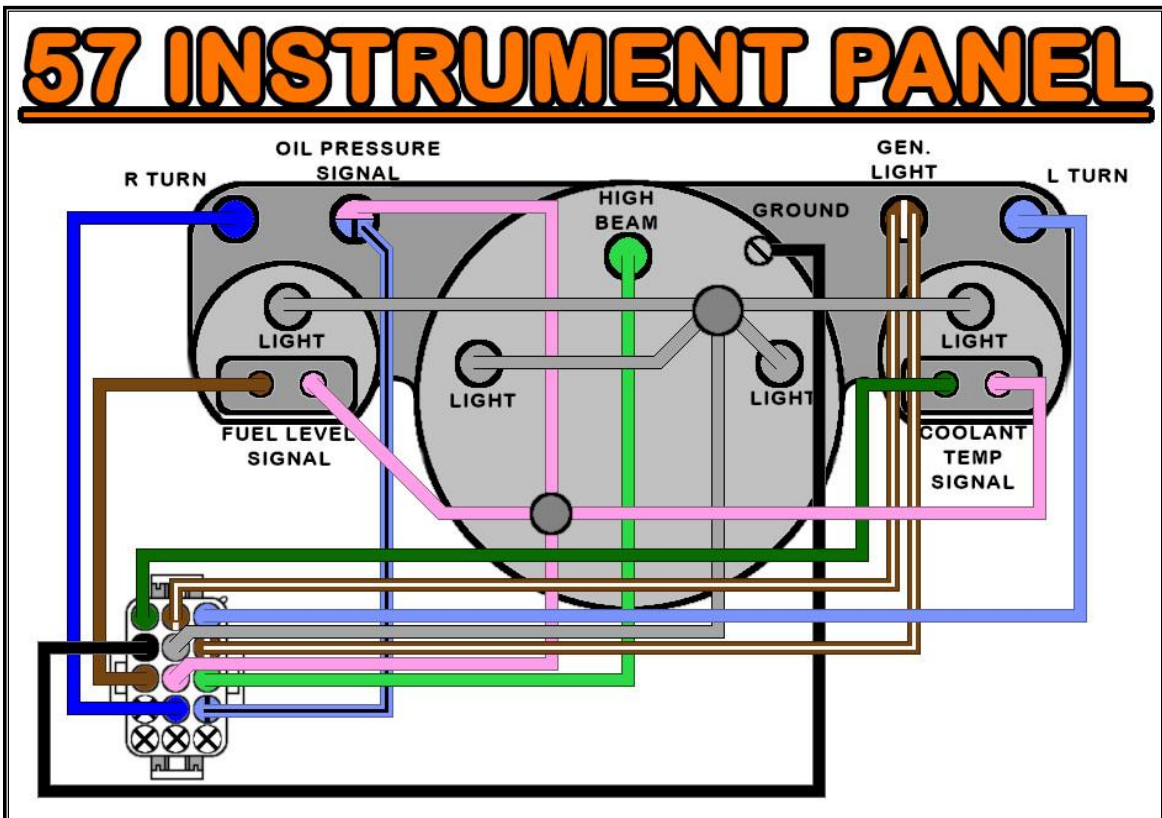
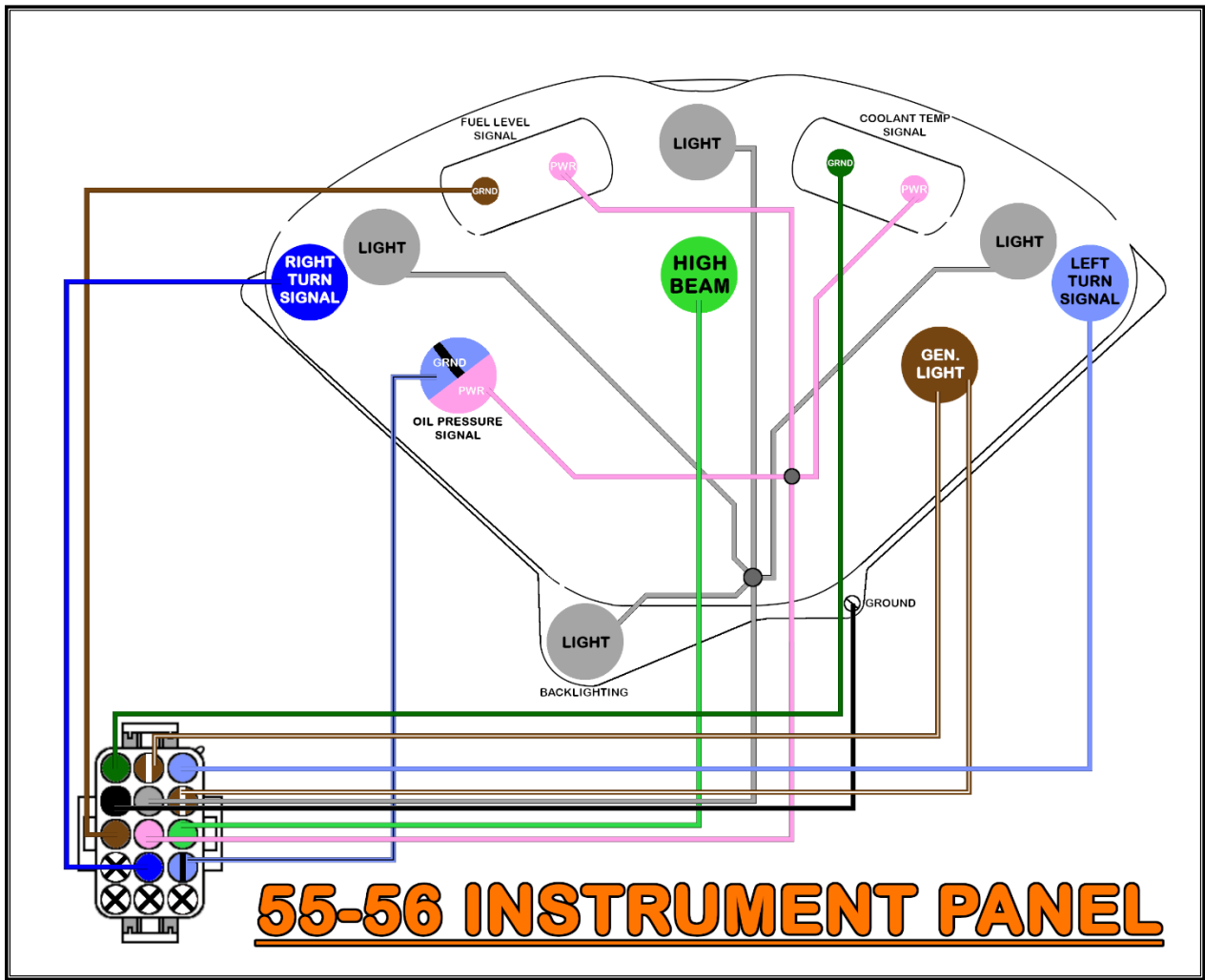

## AFTERMARKET INSTRUMENT PANEL

The following instructions will be universal due to all the different manufacturers of aftermarket gauges. Found in the kit is an aftermarket cluster harness. This sub-harness is made up of the same wires as the main harness listed on [pages 101 – 102](#). Like the [Factory Cluster Harness](#), this [Universal Harness](#) plugs directly into the main harness. However, this sub-harness is universal and will need to be modified by the installer to fit their build. Use the following instructions along with the gauge manufacturer's instructions.

Most electric aftermarket gauges require four or five wire connections:

- Gauge Power - a Switched 12-volt power source: **PINK #935**
- Gauge Ground (some gauges do not require this): **BLACK #969**
- A signal from a sensor or sending unit: **VARIOUS**
- Gauge Light Power - 12-volt power source from the Gauge Lighting circuit: **GREY #930**
- Gauge Light Ground: **BLACK #969**

Most mechanical aftermarket gauges only require two wires to be connected:

- Gauge Light Power - 12-volt power source from the Gauge Lighting circuit: **GREY #930**
- Gauge Light Ground: **BLACK #969**

The requirements for aftermarket gauge controllers (like Dakota Digital) will vary.

- Controller BAT Power – a constant hot 12-volt power source for the control box: **RED #998**
- Controller IGN Power – a Switched 12-volt power source: **PINK #935**
- Signal from a sensor or sending unit: **VARIOUS**; some controllers will already have signal wires and do not require those of the Painless harness.

All of these connections are present in the wiring Painless harness. However, it will be up to the installer to distribute the power for the gauge and the gauge lights as well as the grounds. This additional splicing will be dependent on how the gauge wires are connected to the gauges.

### UNIVERSAL INSTRUMENT PANEL HARNESS

**BROWN/WHITE** [AFTERMARKET CLUSTER] #914 ALT/GEN LIGHT POWER (IGN PWR)

**BROWN/WHITE** [AFTERMARKET CLUSTER] #914 ALT/GEN LIGHT POWER OUT (IGN PWR)

**LT. BLUE** [AFTERMARKET CLUSTER] #937 LEFT TURN INDICATOR

**GREEN** [AFTERMARKET CLUSTER] #921 COOLANT TEMP SIGNAL

**GREY** [AFTERMARKET CLUSTER] #930 INSTRUMENT PANEL LIGHTING

**BLACK** [AFTERMARKET CLUSTER] #969 GROUND

**LT. GREEN** [AFTERMARKET CLUSTER] #936 HIGH BEAM INDICATOR

**PINK** [AFTERMARKET CLUSTER] #935 GAUGE POWER (IGN PWR)

**BROWN** [AFTERMARKET CLUSTER] #939 FUEL LEVEL SIGNAL

**LT. BLUE/BLACK** [AFTERMARKET CLUSTER] #922 OIL PRESSURE SIGNAL

**BLUE** [AFTERMARKET CLUSTER] #938 RIGHT TURN INDICATOR

**GREEN/WHITE** [AFTERMARKET CLUSTER] #923 TACHOMETER SIGNAL

**RED** [AFTERMARKET CLUSTER] #998 GAUGE CONTROLLER BATTERY POWER

## HARDWIRING:

For those who choose to wire aftermarket gauges with just the wires found in the Painless chassis harness, and not purchase an additional gauge harness, the following steps will walk you through the process of distributing power and ground as well as connecting the sender wires. The following diagrams only show temp, oil pressure, volt, and fuel level gauges. Power, ground, and sender wires connect in the same manner to speedometers and tachometers.

Power to the gauges comes from the **PINK #935** wire, and it needs to be connected to the “I” or “12V” post on each gauge. The power wire can be connected in one of two ways:

**#1) Splicing-** This is when you connect multiple wires to a single wire to distribute power/ground to multiple components. In this case, splices on the **PINK #935** wire are running wires to several gauges to provide power to each gauge.

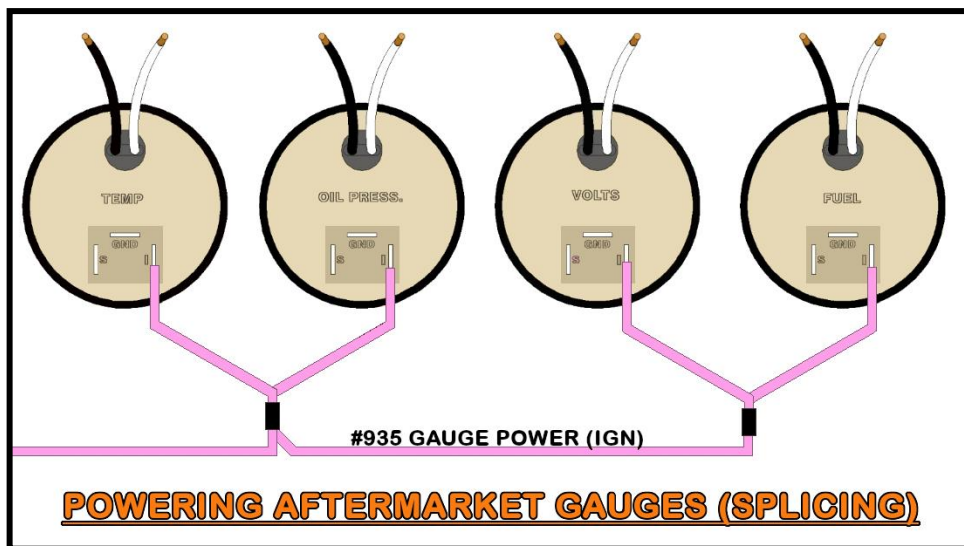

**#2) Chaining or Jumpering-** Run the **PINK #935** wire to a power post. **Before terminating the wire** with the proper terminal, insert another wire into the terminal and crimp. You now have 2 wires in 1 terminal. This additional wire then routes to the next gauge's power post. Before terminating that wire with the proper terminal, insert another wire into the terminal; and so on.

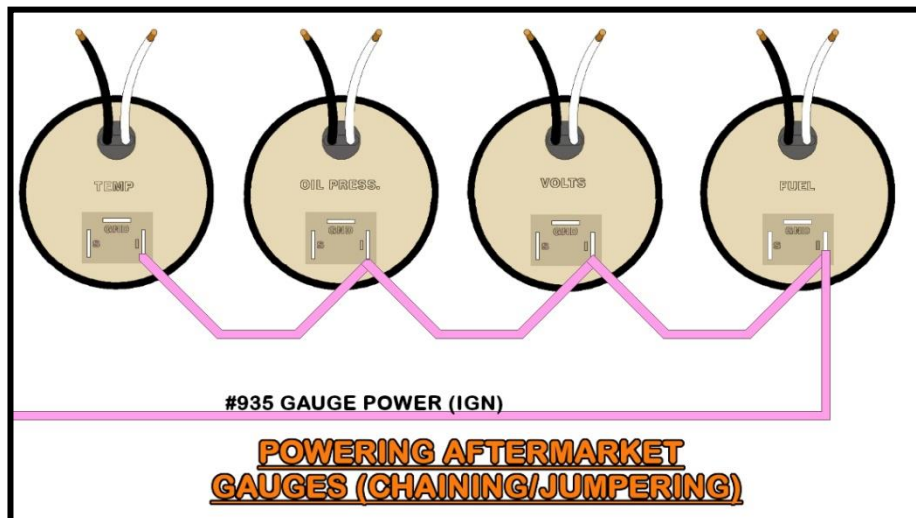

Grounds need to be supplied to the gauge lights and any ground tab on the gauges. The installer needs to run their own ground circuit for gauge connections. To make these ground connections you can splice from the installer-provided ground wires to all the gauges or chain/jumper it all together. Both methods can be seen in the following two drawings:

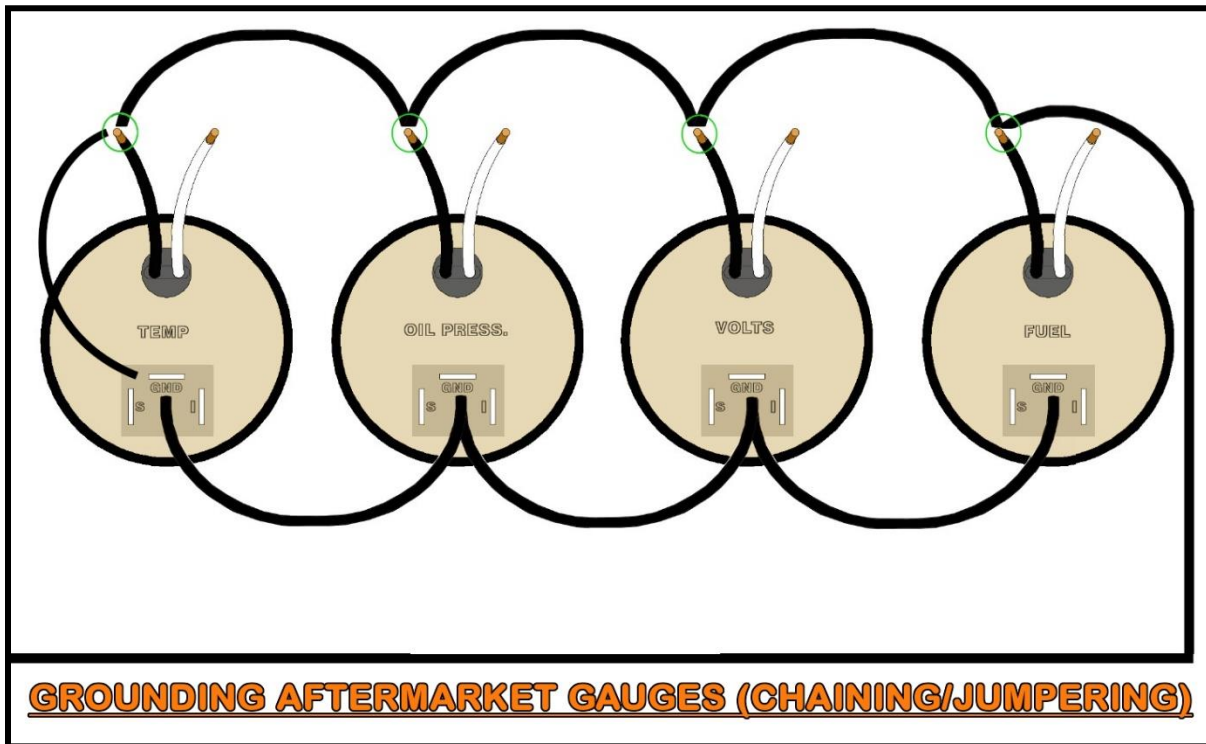
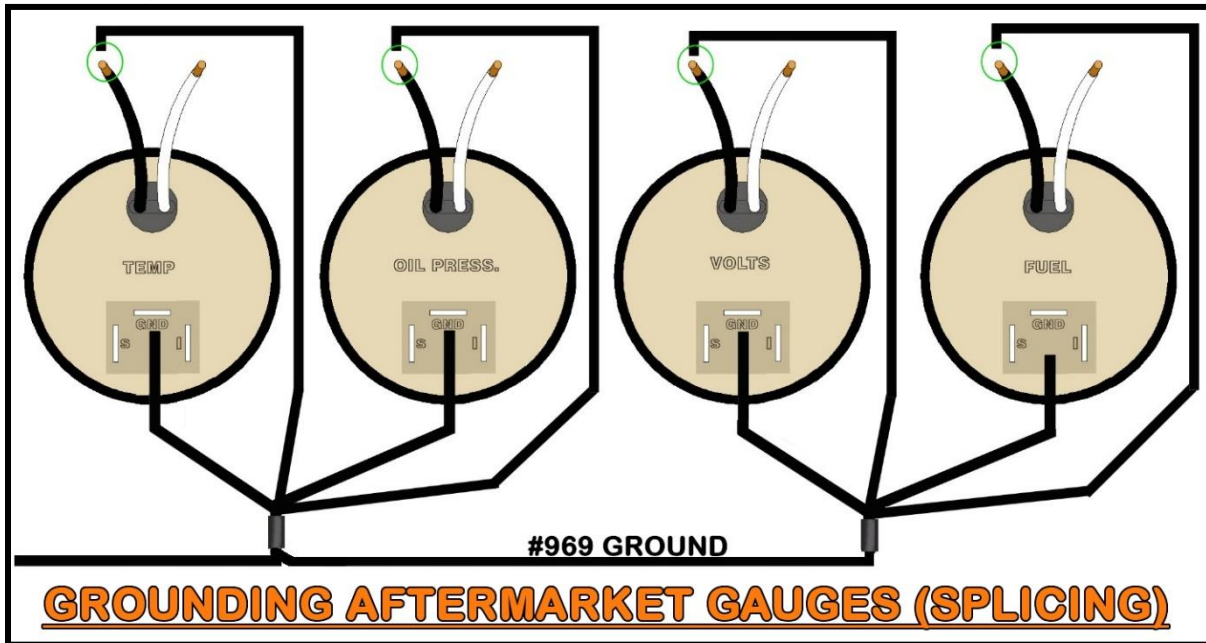

Gauge lightpower is supported by the **GREY #930** wire. This wire connects to one of the leads for the gauge light or the gauge light tab found on gauges with LED backlighting. To make these connections you can splice from this **GREY #930** wire to all the gauges or chain/jumper it all together.

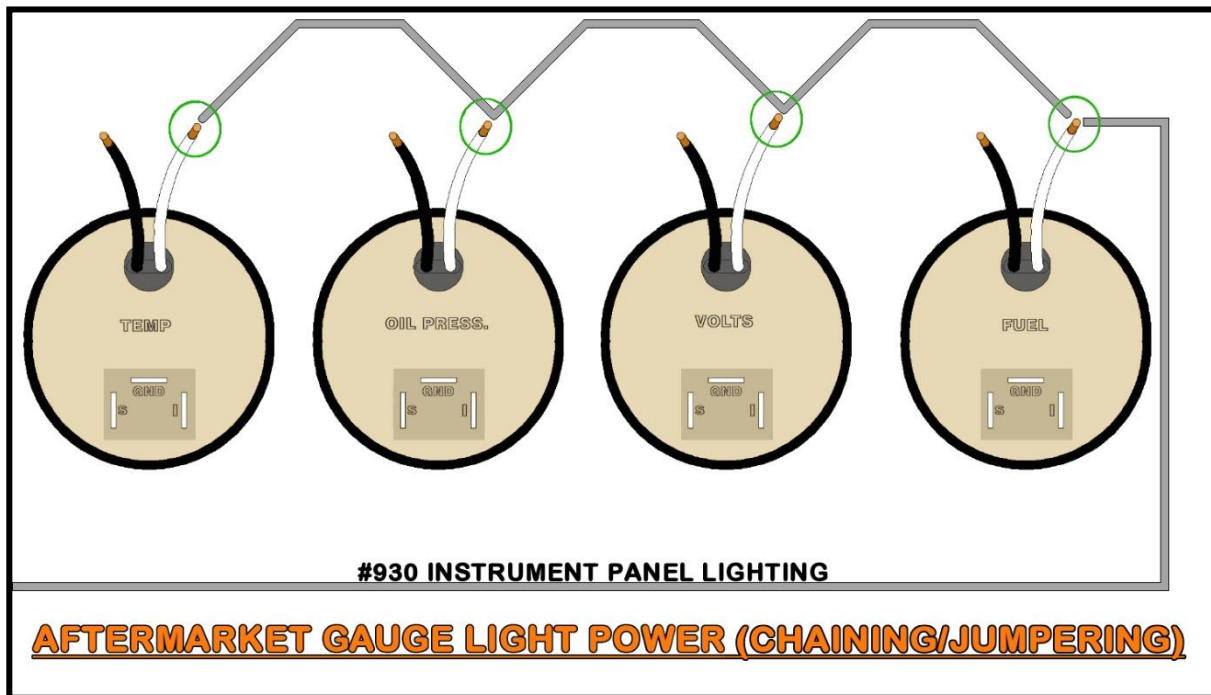
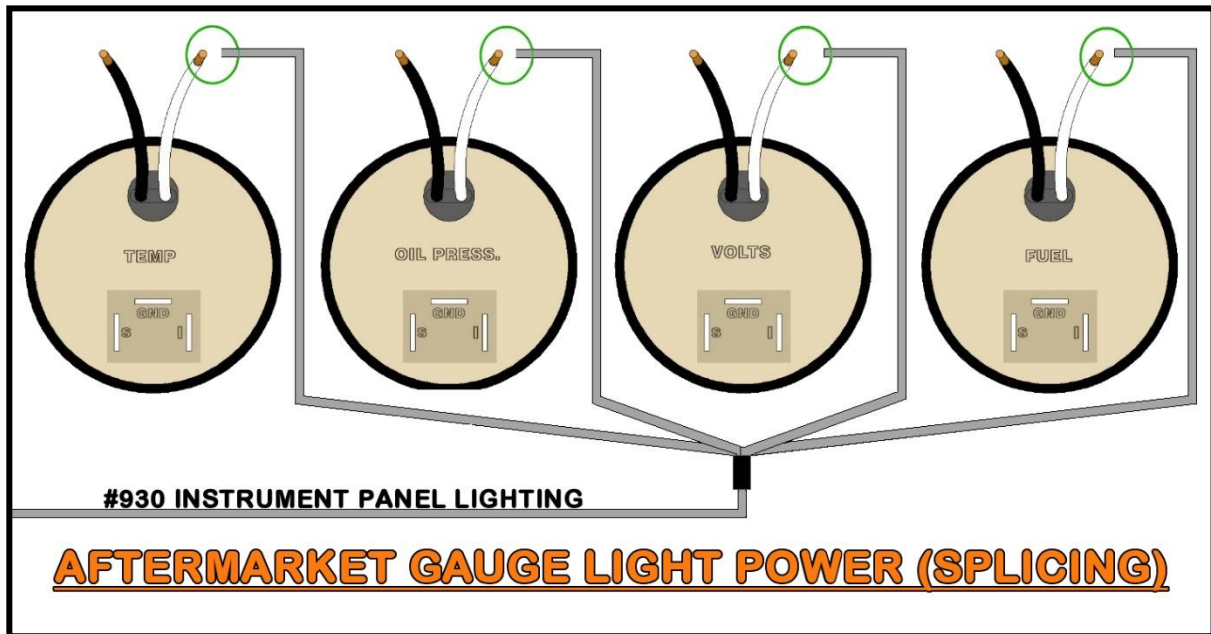

The last connections that need to be made are the sending unit wires or signal wires. These are the wires which come from the temperature sending unit, oil pressure sending unit, and fuel level sending unit. Not shown in the diagram, but also provided in the Painless chassis harness is the **GREEN/WHITE #923 TACHOMETER SIGNAL** wire.

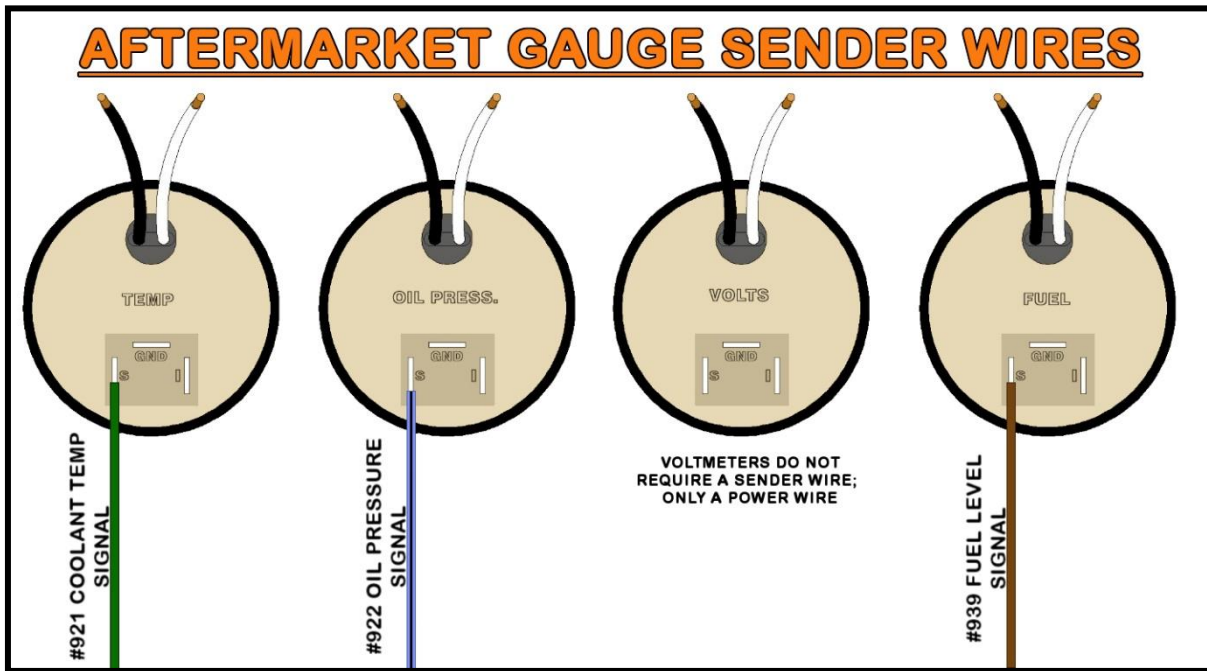

**NOTES:**

# **AFTERMARKET DASH-MOUNTED GAUGES**

An addition to the Painless harness, and not found on a factory harness, is a connection that provides all the wires needed for aftermarket electric or mechanical gauges.

This connection is intended for those using aftermarket gauges mounted on the lower portion of the dash and for those running an aftermarket tachometer mounted on the steering column or elsewhere on the dash. If you have an aftermarket tach mounted in the actual gauge cluster, the connection to this tach took place in the previous section. If you are mounting gauges on the dash below the radio, on the console, steering column, etc., this connection is useful to you as you do not have to cut and splice into any of the other gauge wires on your new Painless harness.



If you have an aftermarket tach mounted in the actual gauge cluster, the connection to this tach took place in the previous section. If you are mounting gauges on the dash below the radio, on the console, steering column, etc., this connection is useful to you as you do not have to cut and splice into any of the other gauge wires on your new Painless harness.

This connection on the Painless harness consists of a six-pin white connector with six wires. The wires in this connector, which can be seen in the [Aftermarket Gauge Schematic](#) on the next page, are:

**BLACK:** 18-gauge wire, not printed; this wire provides a ground source. This wire is tied into the integrated ground circuit and can be seen in the [Ground Splice Schematic](#) on [page 100](#).

**GREY:** 18-gauge wire, printed **[AFTMKT GAUGES] #930 BACKLIGHT POWER**; this wire provides a power source for the gauge light(s). The **GREY #930** is tied to the other **#930** wires coming from the headlight switch to things like the radio backlight/dim, panel lights, and gear indicator light. This wire has power anytime the headlight switch is in the Park/Tail Lights ON or Headlights ON position. This wire can also be seen in the [Headlight Switch Schematic](#) on [page 71](#).

**PINK:** 18-gauge wire, printed **[AFTMKT GAUGES] #935 GAUGE POWER (IGN PWR)**; this wire provides a switched ignition power source for any gauges. This wire comes from a splice with a wire that comes from the 10-amp, GAUGES fuse on the fuse block. This wire has power anytime the key is in the ON/RUN position.

**GREEN:** 18-gauge wire, printed **[AFTMKT GAUGES] #921 COOLANT TEMP SIGNAL**; This wire is a ground signal from the engine coolant sending unit. The resistance to ground varies on this wire according to engine temperature.

**GREEN/WHITE:** 18-gauge wire, printed **[AFTMKT GAUGES] #923 TACHOMETER SIGNAL**; this wire is a ground signal from the negative (-) side of the ignition coil. This wire can also be seen in the coil/ignition connection diagrams on [pages 49 & 50](#).



**LT. BLUE/BLACK:** 18-gauge wire, printed [AFTMKT GAUGES] #922 OIL PRESSURE SIGNAL; this wire is a ground signal from the oil pressure sending unit. The resistance to ground varies on this wire according to oil pressure.

# AFTERMARKET GAUGE

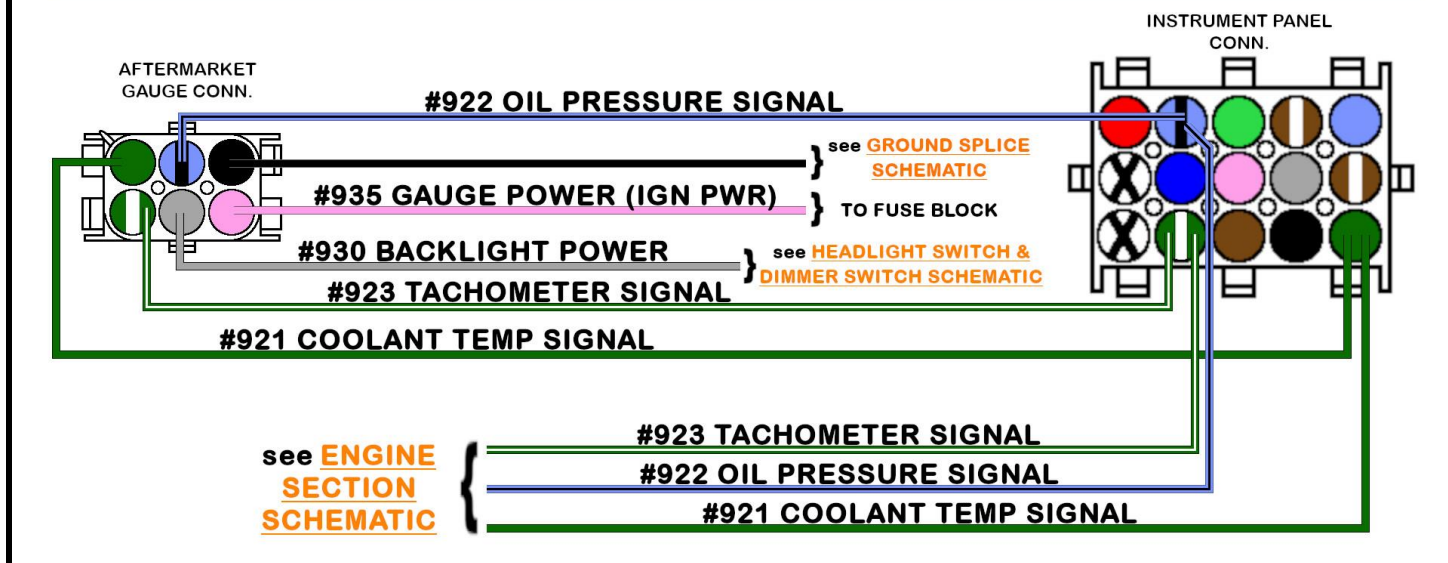

A mating connector and terminals are provided to allow connections to be made to gauges without having to hard wire the Painless harness directly to the gauges.

- Plug the wires going to your aftermarket gauges into the provided connector using the pinout below.
- See the Hardwiring section on [page 107](#) for how to route gauge power/ground and backlighting power/ground from the mating connector to the gauge(s).

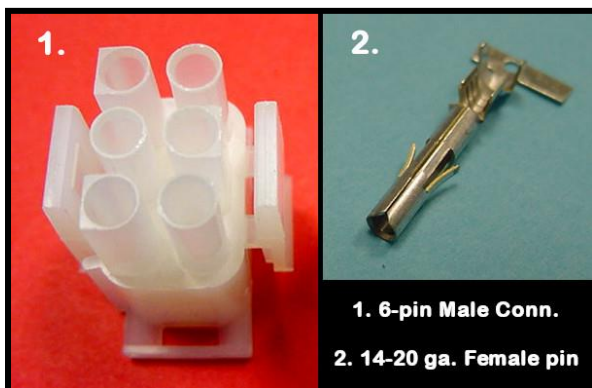

1. 6-pin Male Conn.

2. 14-20 ga. Female pin

## AFTERMARKET GAUGES MATING CONNECTOR

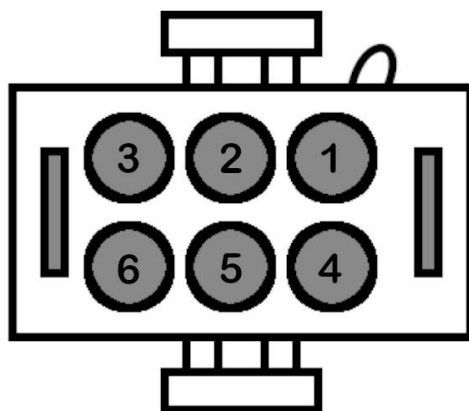

1. Gauge/Light Ground
2. Oil Pressure Signal
3. Coolant Temp Signal
4. Gauge Power
5. Backlighting Power
6. Tachometer Signal

WIRE SIDE/TERMINAL INSERTION VIEW PAY ATTENTION TO HOW THIS CONNECTOR IS NUMBERED

# RADIO

The instructions in this section are universal since most people have replaced the factory radio at this point. The Painless harness includes five wires dedicated to a connection to the radio. They are:

**YELLOW:** 18-gauge wire, printed **[RADIO SECTION] #940 RADIO BATTERY POWER;** this wire provides the radio a battery power source that allows the time and radio presets to remain every time the ignition is turned off. This wire comes from one of the 10-amp RADIO fuses.

**RED:** 18-gauge wire, printed **[RADIO SECTION] #941 RADIO IGN POWER;** this wire provides the radio with ignition-switched power for operation. This wire has power when the ignition switch is in the ACCESSORY and ON/RUN positions. This wire comes from the other 10-amp RADIO fuse of the fuse block.

**BLACK:** 18-gauge wire, printed **[RADIO SECTION] #969 RADIO GROUND;** this wire provides a ground source for the radio and is tied to the ground splice seen on [page 100](#).

**GREY:** 18-gauge wire, printed **[RADIO SECTION] #930 RADIO BACKLIGHTING;** this wire will provide a power source to illuminate the backlighting. This wire will have power anytime the headlight switch is in the Park/Tail Lights ON or Headlights ON position. This wire/splice can be seen in the [Headlight Switch & Dimmer Switch Schematic](#) on [page 71](#).

**BLUE:** 18-gauge wire, printed **[RADIO SECTION] #999 AMP TURN ON [TAIL SECTION];** this wire provides switched power from the head unit to an amplifier. You will only need this wire if you have an audio amplifier.

Many older radios (like the 1957 factory radio) require one power source, Painless recommends connecting the **RED #941** wire to the radio in these circumstances so that the radio will only operate when the ignition switch is in the ACCESSORY or ON/RUN position. This will prevent the radio from draining the battery if it is accidentally left on.

- If you are using an aftermarket radio, refer to the manufacturer's installation guide for proper connection.
- Not all wires may be used. If you are not using an amplifier, the **BLUE #999** lay-in wire can be removed from the harness.

# RADIO SECTION

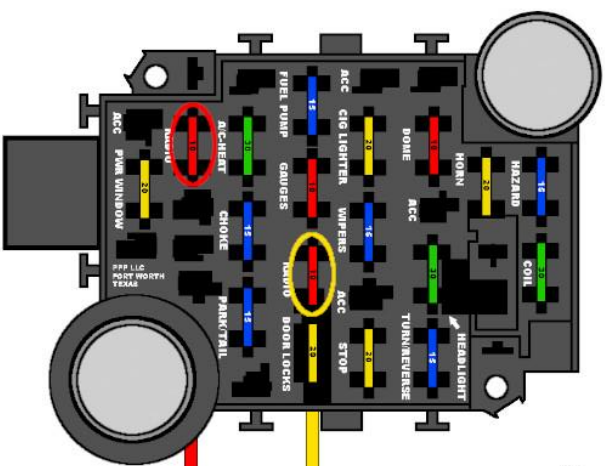

see **HEADLIGHT SWITCH SECTION SCHEMATIC**

{ #930 RADIO BACKLIGHTING

see **GROUND SPLICE SCHEMATIC**

{ #969 RADIO GROUND

#940 RADIO BATTERY POWER

#941 RADIO IGN POWER

see **TAIL SECTION SCHEMATIC**

{ #999 AMP TURN ON

# RADIO

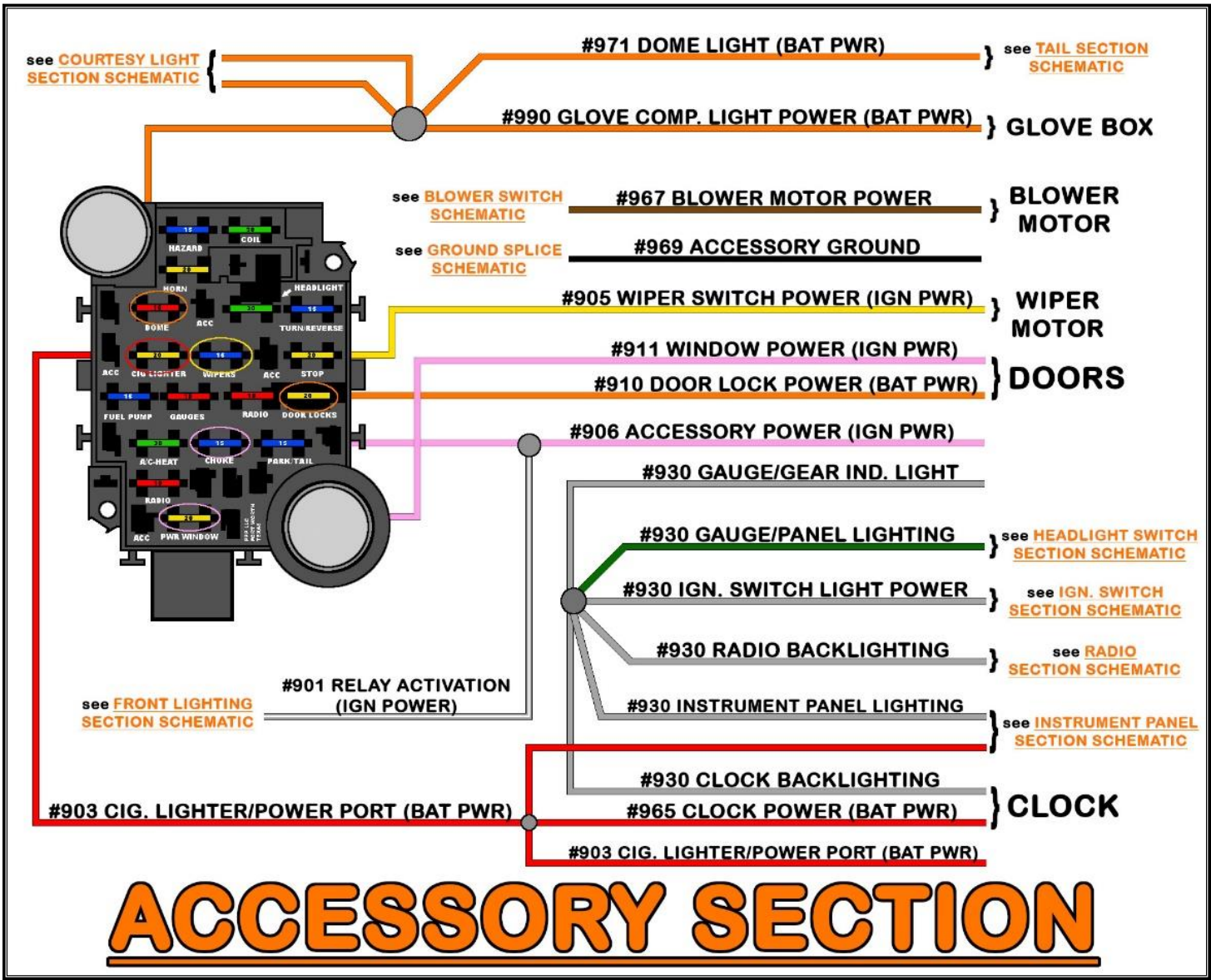

# ACCESSORY SECTION

# ACCESSOR SECTION

The **Accessory Section** of the Painless harness consists of eleven wires for various accessory applications. Locations of all of these components vary from vehicle to vehicle, so no specific routing instructions can be given.

## ACCESSORIES

**PINK:** 16-gauge wire, printed **[ACC. SECTION] #906 ACCESSORY POWER (IGN PWR)**; this wire provides a switched ignition power source for an accessory not exceeding 15 amps. If you need to power multiple accessories, you must splice or chain this wire to the various accessories. Linking or chaining was explained on [page 107](#) in the hardwiring section. This wire can also be used to power an accessory relay as seen in the schematics below and on the next page.

**BLACK:** 16-gauge wire, printed **[ACC. SECTION] #969 ACCESSORY GROUND**; this wire provides a ground source for accessories. If you need to ground multiple accessories, you must splice or chain this wire to the various accessories. Linking or chaining was explained on [page 101](#) in the **Instrument Panel** section

**GREY:** 18-gauge wire, printed **[ACC. SECTION] #930 GAUGE/GEAR IND. LIGHT**; this wire provides backlighting to the gear shift panel or any accessory panels or switches. If you need to light multiple panels, you must splice or chain this wire to the various accessories. Linking or chaining was explained on [page 101](#) in the **Instrument Panel** section. This wire has power anytime the headlight switch is in the Park/Taillights ON or Headlights ON position.

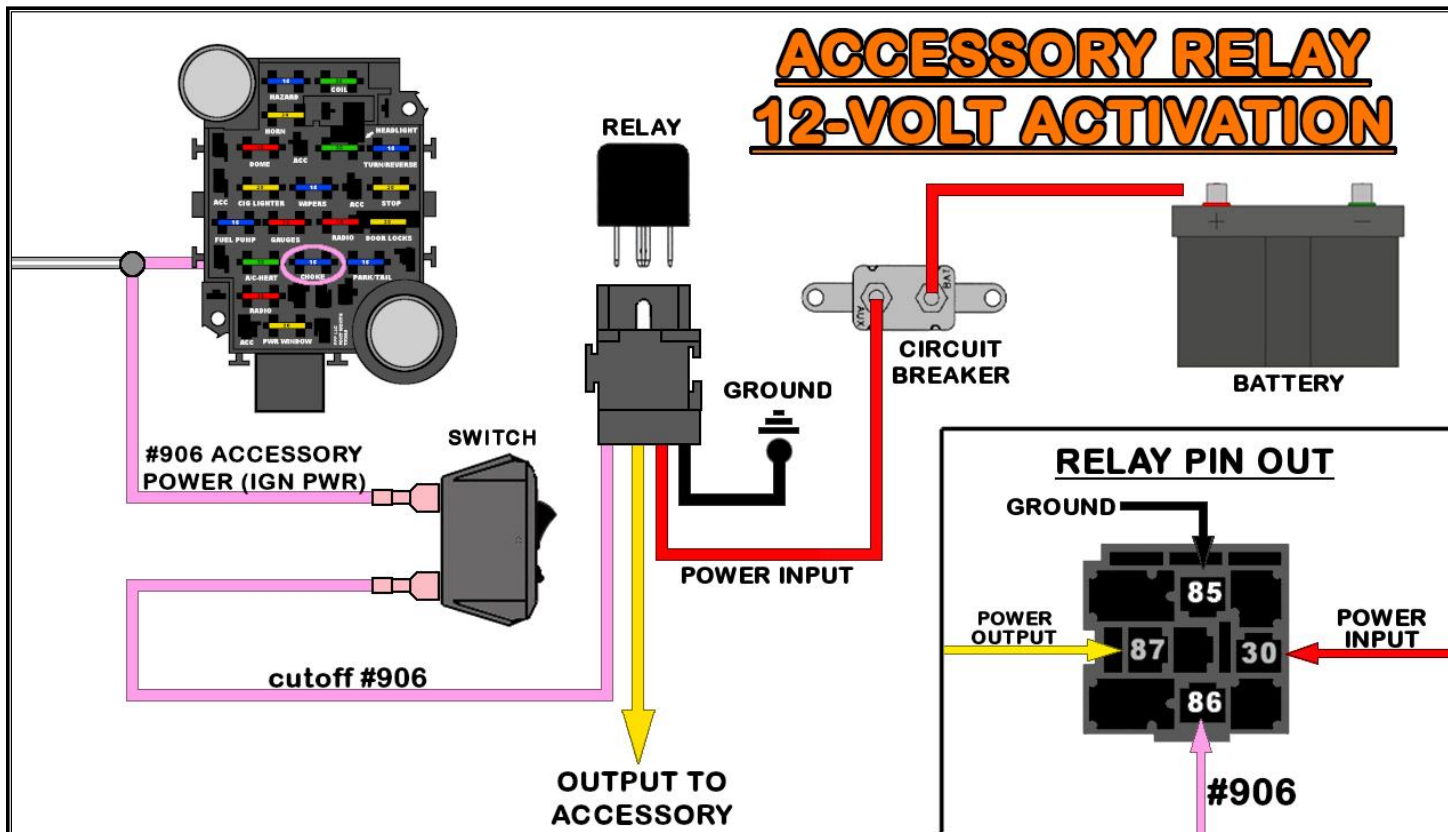

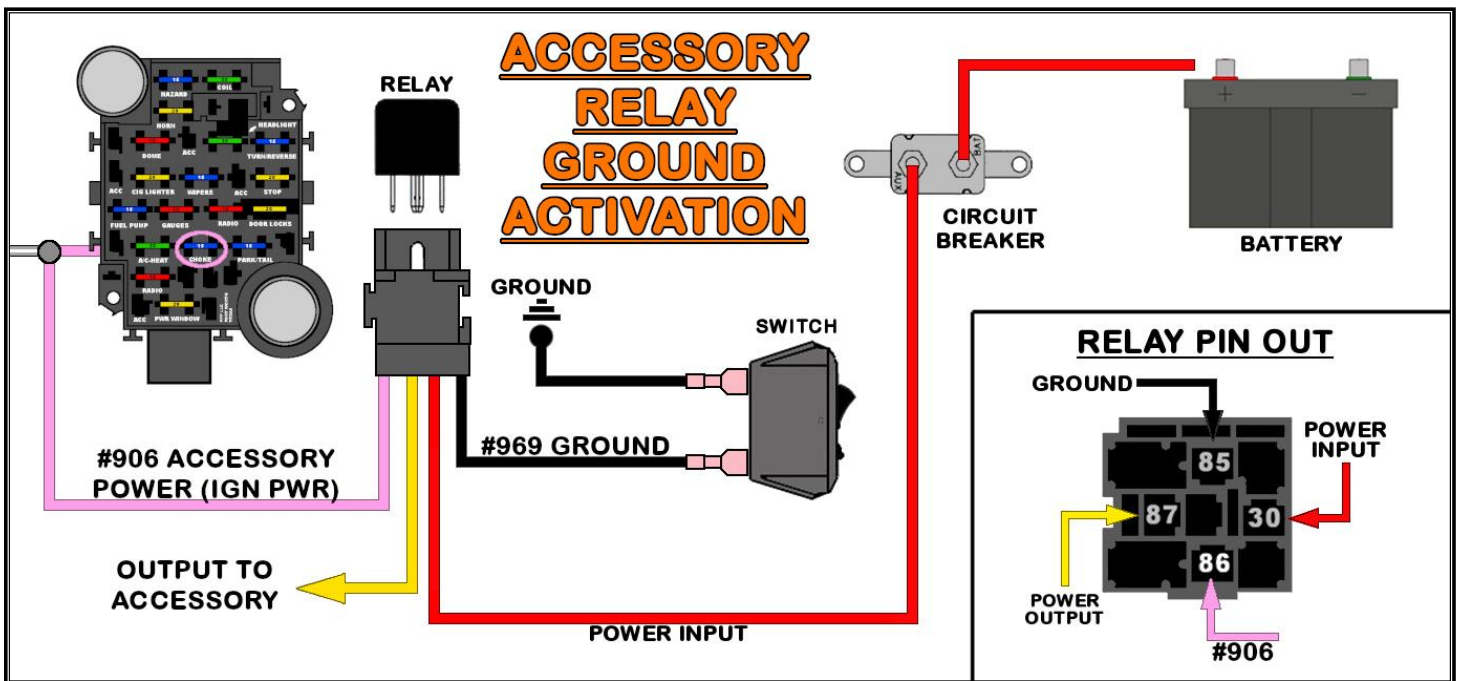

## WIPER SYSTEM

**YELLOW:** 16-gauge wire, printed [ACC. SECTION]#905 WIPER SWITCH POWER (IGN PWR); this wire provides ignition switched power to the wiper motor or switch depending on your set-up and comes from the 15-amp WIPER fuse.

- This wire should have been rerouted to either the wiper motor or wiper switch on [page 19](#). See the [Wiper Motor Section](#) on [page 51](#) and the [Wiper Switch Section](#) on [page 75](#).
- If you do not have an electrical wiper system, this wire can be used to power some other accessory so long as the max amperage does not exceed 10 amps.
- If you do not need the **YELLOW #905** wire, cap and stow it away under the dash. Painless does not recommend removing any power wires as they may be needed at a future date.

## CIGARETTE LIGHTER / POWER PORT



The Cigarette Lighter/Power Port connection on the Painless harness is set up for a universal application since most sockets have been replaced by aftermarket sockets. Typically, the cigarette lighter is more commonly used as a power port to charge and run electronic components requiring a 12vDC power source.

**RED:** 16-gauge wire, printed, [ACC.SECTION] #903 **CIG. LIGHTER/POWER PORT (BAT PWR)**; this wire comes from the 20-amp CIG LIGHTER fuse and provides a battery power source to a cigarette light/power port

- Route the **RED #903** wire to the cigarette lighter/power port.
- Cut the wire to length and connect according to one of the following options:
  - Ring terminals and bullet/socket/spade style terminals are provided in the parts kit to connect universal aftermarket lighters/power ports. **Universal Lighter socket part #56458**, seen in the photo, can be found at most local parts stores. A ground wire is needed
  - For those with a factory socket, you can cut the connector from your factory harness. Leave **3"** or **4"** of wire to create a pigtail and splice it to the **RED #903** wire on the Painless harness. Splices have been provided in the parts kit.

## GLOVE BOX SWITCH

The glove box switch is a simple, plunger-activated light that illuminates the inside of the glove box when the glove box door is opened. The glove box switch requires a single power wire to function correctly, as it grounds through its mounting.

**ORANGE:** 18-gauge wire, printed [ACC.SECTION] #990 **GLOVE COMP. LIGHT POWER (BAT PWR)**; this wire provides power to the glove box light from the 10-amp DOME fuse on the fuse block. This fuse is battery-powered and always has power.

- Route the **ORANGE #990** wire to the glove box light and cut to length.
- If there is a male terminal on the wire coming from the glove box light socket, or the socket itself, connect to it using the **single pin 56 series connectors** and **female terminals** found in the kit (**see right**).
- Alternately, butt splices and heat shrink from the parts kit can be used to splice the **ORANGE #990** to the glove box light socket wire.

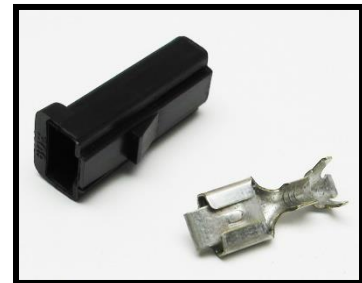

## **POWER WINDOWS & POWER LOCKS**

Two accessory wires have been provided in the **Accessory Section** for those with power windows and/or power locks. These wires are:

**PINK:** 12-gauge wire, printed **[ACC.SECTION] #911 WINDOW POWER (IGN PWR)**; this wire provides a switched ignition power source for power windows from the 20-amp PWR WINDOW fuse. This wire provides power to the windows any time the ignition key is in the ACCESSORY or ON/RUN position.

**ORANGE:** 12-gauge wire, printed **[ACC.SECTION] #910 DOOR LOCK POWER (BAT PWR)**; this wire provides a battery power source, from the 20-amp DOOR LOCKS fuse. This wire provides constant battery power for door locks.

- For those installing aftermarket power locks, connect the **ORANGE #910** wire to the wire or switch/relay input that requires a fused battery power source.
- For those installing aftermarket power windows, connect the **PINK #911** wire to the wire or switch/relay input that requires a fused switched ignition power source.

## **BLOWER MOTOR**

In most cases, the blower motor is located on the passenger side under the dash; though, some deluxe setups place the blower motor in the engine compartment. If this is the case, the **BROWN #967** wire should have been rerouted on [page 20](#).

**BROWN:** 14-gauge wire, printed **[ACC.SECTION] #967 BLOWER MOTOR POWER**; this wire provides power to the blower motor from the blower switch.

- Most blowers will be hardwired with a power wire. Route the **BROWN #967** wire towards the blower motor power wire, cut to length, and connect using the **1.5" 56 series single-pin connectors** and **female terminals** found in the kit
- Alternately, butt splices and heat shrink from the parts kit can be used to splice the **BROWN #967** to the blower motor power wire.
- If your blower motor has a ground wire, you will need to supply a ground connection.





## CLOCK

Clocks came as an option from the factory and were mounted on the passenger's side of the dash. The clocks then had a small harness that plugged into the main factory harness. Your Painless harness has been set up in the same manner in that there is a separate clock harness included in the kit. This sub-harness has a power wire and two light sockets for backlighting. The sub-harness will connect to two wires of the main harness after installing the proper connector. They are:

**RED:** 18-gauge wire, printed **[ACC.SECTION] #965 CLOCK POWER (BAT PWR)**; this wire provides power to the clock from the 20-amp CIG LIGHTER fuse on the fuse block. This fuse is battery-powered and always has power.

**GREY:** 18-gauge wire, printed **[ACC. SECTION] #930 CLOCK BACKLIGHTING**; this wire provides backlighting to the clock. This wire has power anytime the headlight switch is in the Park/Tailights ON or Headlights ON position

- Route both main harness wires to the clock, cut to length, and install **(2) female 56 series terminals** and the **2-pin 56 series connector** provided (**see right**).
- Plug the clock sub-harness into the clock. While all three years require the **RED #965** power wire, only the 1957's clock requires both light sockets. If you are installing this in a 1955 or 1956 model, one of the light sockets can be cut off at the sub-harness 2-pin connector.



# PASSENGER COURTESY LIGHT SECTION

The Passenger Courtesy Lights Section has three wires for the courtesy light and jamb switch. The Driver Courtesy Light Section was covered on [page 67](#).

## PASSENGER DOOR JAMB SWITCH

The door jamb switch provides a ground activation for the courtesy lights and dome light. When the door is opened, the plunger on the switch extends out as it is no longer being pushed in by the door. When the plunger extends, the contact point on the back of the switch contacts the body of the switch, which is grounded through the mounting into the metal door jamb. This grounding gives the wire attached to the switch a ground source which will then cause the interior lights to turn on.

Locate the wire in the courtesy light section intended for the passenger door jamb switch. It is:

**WHITE:** 18-gauge wire, printed **[COURTESY LIGHT] #961 PASSENGER SIDE DOOR JAMB SWITCH**; this wire is spliced to other white wires leading to the dome light, courtesy light, headlight switch, and the driver side door jamb switch. This wire is grounded anytime either door is opened, or when the headlight switch knob is rotated to the "DOME LIGHT ON" position. This wire can be seen in the [Courtesy Lights Schematic](#) on [page 69](#).



- Route the **WHITE #961** wire to the passenger-side door jamb switch and use a **1/4" uninsulated male terminal** and **heat shrink** from the parts kit to connect to a factory-style jamb switch.

- If you have an aftermarket switch, you may need to supply a terminal. If you find that your door jamb switch has two tabs, it does not matter which tab the **#961** connects to.



If this is a new build/restoration or your original switches are just in bad shape and new switches are needed, Painless offers factory-style GM jamb switches as **part #80170**. Please note that **part #80170** is for one switch, and each door requires a switch. Use the **18-20 gauge insulated bullet terminal** from the parts kit to connect to this style switch.

## **PASSENGER COURTESY LIGHT**

This connection allows the passenger side under the dash/floorboard of the vehicle to be illuminated any time a door is open or when the headlight switch is activating the dome light.

These wires can be seen in the [Courtesy Lights Schematic](#) on [page 69](#):

**ORANGE:** 18-gauge, **[COURTESY LIGHT] #971 PASS. COURTESY LIGHT (BAT PWR)**; this wire provides power to the passenger courtesy light from the 10-amp DOME fuse on the fuse block. This fuse is battery-powered and always has power.



**WHITE:** 18-gauge, printed **[COURTESY LIGHT] #961 PASS. COURTESY LIGHT GROUND**; this is the ground wire that activates the courtesy light. When this wire is grounded, it completes the voltage path and causes the light to illuminate. This ground comes from either of the door jamb switches, if the door is opened, or the headlight switch when it is turned to the “DOME LIGHT ON” position.

- Locate a lamp socket and terminals from the parts kit. This light socket can use either a **63 or 67 series bulb (not included)**.
- Locate a suitable mounting location under the passenger’s side of the dash. The light socket has a small hole in a mounting tab to allow mounting. This kit provides both **1/2” self-tapping screws** and **small zip ties** to accommodate the various ways you might affix the socket. You may also use screws that hold existing trim. **Do not mount the socket at this time.**
- Route the wires to where the socket will be mounted and cut to length.
- Strip **1/4”** of insulation from each wire and install the terminals; crimp the smaller, brass terminal to the **WHITE #961** wire and the larger terminal to the **ORANGE #971** wire.
- Insert the terminals into the connector, install a **#67 bulb (not included)**, and mount the socket.

# **TAIL SECTION**

The **Tail Section** wires are the last group to be connected. This group of wires connect to the right & left turn/brake lights, taillights, reverse lights, license plate light, dome light, amplifier/accessory power, fuel pump, and fuel level sending unit. All the wires found in the **Tail Section** can be seen in the schematics found on [page 129](#).

Most of the hardware needed for this section can be found in the bag of the parts kit labeled "TAIL."

## **DOMELIGHT**

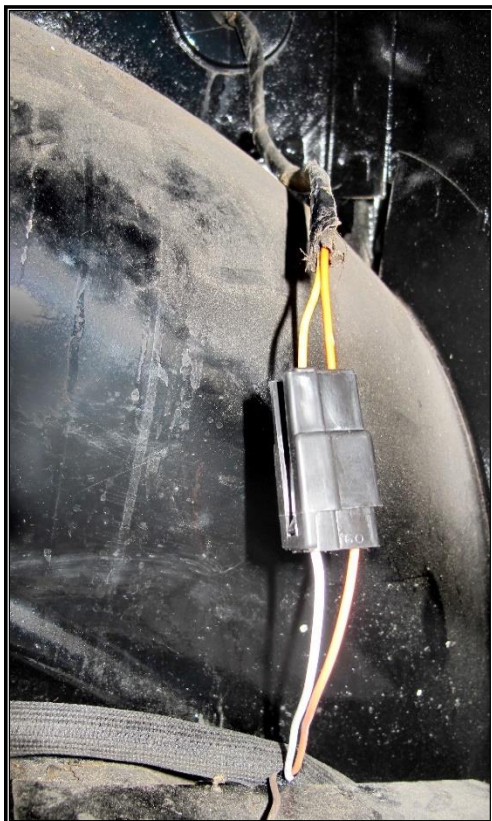

The dome light has constant battery power applied to it. This light is ground activated by the door jamb switches and also by turning the headlight switch to the DOME LIGHT ON position. These wires can be seen in the [Tail Section Schematic](#) on [pages 129](#), and in the [Courtesy Lights Schematic](#) on [page 69](#), they are:

**ORANGE**: 18-gauge wire, printed **[TAIL SECTION] #971 DOME LIGHT (BAT PWR)**; this power wire comes from the 10-amp DOME fuse on the fuse block; this fuse has battery power and is "hot" at all times.

**WHITE**: 18-gauge wire, printed **[TAIL SECTION] #961 DOME LIGHT GROUND**; this wire is the ground wire that activates the dome light. When this wire is grounded it completes the voltage path causing the light to illuminate. This ground will come from either a door jamb switch or the headlight switch.

- In most cases, these wires will attach to the factory dome light wires. The factory wires coming from the dome light can usually be seen in the trunk, on the driver's side, near the trunk hinge.



- Connect the Painless harness to the factory pigtail coming from the dome light using the **2-pin connector** and **terminals** seen to the left.
- If you do not have a factory pigtail, there has been ample length supplied to allow routing of the **ORANGE #971** and the **WHITE #961** to the dome light fixture. In most cases, this will require the headliner of the vehicle to be removed. You will need new terminals, though, to connect to your existing dome light fixture.

## FUEL SECTION

Painless provides 2 wires for the fuel section: a connection from the fuel level sender to the gauge and switched, 12v power for a low-pressure, in-line, electric fuel pump.

### Fuel Sender

The fuel level sending unit is a potentiometer with an arm and float attached to the end. The float moves up or down with the fuel level in the tank and varies the resistance on the potentiometer. This changes the current flow to the fuel gauge and moves the indicator needle to correspond with the current fuel level in the tank. For the fuel gauge to work properly, the fuel level sending unit's resistance range **MUST** match the gauges operating range.

**BROWN**: 18-gauge wire, **[TAIL SECTION] #939 FUEL LEVEL SIGNAL [INSTRUMENT PANEL]**; this wire sends the ground signal from the fuel level sending unit to the fuel level gauge.

- Route the **BROWN #939** wire through the factory hole in the trunk pan to the fuel level sending unit using the  $\frac{1}{2}$ " **rubber grommet** found in the parts kit (see right).



- The parts kit provides ring terminals and heat shrink to make this connection.
- **The sending unit must be grounded to work properly**; Painless does not offer a wire specifically for this. Some sending units have a tab for a ground connection while others may rely on the sending unit mounting. If your sending unit has a ground tab, run a wire from a clean chassis ground source to this tab.



- If you do not have a ground tab, run a ground wire from a clean chassis ground source to one of the mounting bolts of the sending unit. Do not rely on a ground through the mounting of the sending unit to the tank.

## Fuel Pump

**RED:** 16-gauge wire, printed [TAIL SECTION] #947 FUEL PUMP (IGN PWR); this wire provides a power source to an electric fuel pump. This wire comes from the 15-amp FUEL PUMP fuse on the fuse block and only has power when the ignition switch is in the ON/RUN position and the START position.



- If a mechanical pump is being used, this wire can be used to power any component needing a switched ignition power source, not exceeding 15 amps.
- **DO NOT USE THIS WIRE FOR AN EFI PUMP**. An EFI fuel pump requires a fuel pump relay and not this wire. This is only for a low-pressure pump on a carbureted system.
- Once in the trunk area, route this #947 out of the hole in the trunk that the fuel sending unit wire exits the trunk from. Also, there is a second hole through the trunk near the trunk latch that can be used if your fuel pump is located closer to the rear bumper. This is the access point for the license plate light wire.
- Using the terminal from the parts kit that matches the connection your pump requires, connect the #947 wire to the power or + post/tab/wire of the fuel pump.
- At this time, you will need to provide a ground wire. This harness does not provide a ground wire for an electric fuel pump, but a ground can be easily connected using terminals from the parts kit and a length of scrap wire created during a previous connection. Simply connect the ground or - post/tab/wire of the fuel pump to one of the mounting bolts holding the fuel pump to the frame/body.

## THIRD BRAKE LIGHT

Third brake lights are a popular aftermarket add-on for the Tri-Five. As such, the Painless harness provides you with a power source for this feature. It is:

**ORANGE:** 18-gauge wire, printed [TAIL SECTION] #950 BRAKE LIGHT POWER (SEPARATE/3RD BRAKE ONLY); this wire provides power to the brake lights on vehicles with a third brake light, and has power anytime the brake pedal is pressed or the hazard switch is activated. This wire can be seen in the [Tail Section Schematic](#) on [page 129](#).

**If you do not have a 3<sup>rd</sup> brake light, install an insulated terminal on this ORANGE #950 wire and tape it up into the harness, this wire will not be used.**

- If you have a third brake light, route the **ORANGE #950** brake light wire to it. If your housing requires a ground source, you must supply a ground wire.

- Cut the wires to length and connect to the appropriate contact/wire in the housings/assemblies. Consult the manufacturer's instructions when you are using aftermarket assemblies. Splices are provided to make these connections.

## **LEFT TURN / BRAKE / TAILLIGHT**

To begin making connections to the taillight, locate the wires in the tail section dedicated to these functions, they are:

**PINK:** 16-gauge wire, printed **[TAIL SECTION] #949 LEFT TURN / BRAKE**; this wire provides power to the left turn signal. This wire has power anytime the turn signal is in the down/left position and the ignition switch is in the *ON/RUN* position. For vehicles with integrated turn/brake signals, this wire is also the brake light power. The wire has power anytime the brake pedal is pressed or anytime the hazard switch is activated. This wire can be seen in the [Tail Section Schematic](#) on [page 129](#).

**BLACK:** 16-gauge wires, printed **[TAIL SECTION] #929 LEFT TAILLIGHT**; this wire provides the taillight power. This wire receives power from the headlight switch and has power anytime the headlight switch is pulled into the *PARK/TAIL LIGHT ON* and *HEADLIGHT ON* positions. This wire can be seen in the [Tail Section Schematic](#) on [page 129](#).

- Loosely route the **BLACK #929** taillight wire to the taillight. On integrated brake/turn housings/assemblies with a dual filament bulb, this will be the dimmer filament.
- Loosely route the **PINK #949** turn signal/brake wire to the taillight. On integrated brake/turn housings/assemblies with a dual filament bulb, this will be the brighter filament.
- Cut the wires to length, and slide a **boot** over both wires. Then strip  $\frac{1}{4}$ " of insulation from each and attach the terminals shown above. Install the newly terminated wires into the contact assembly.
- Install the completed assembly into the factory taillight socket. Finally, slide the boot over the contact assembly.

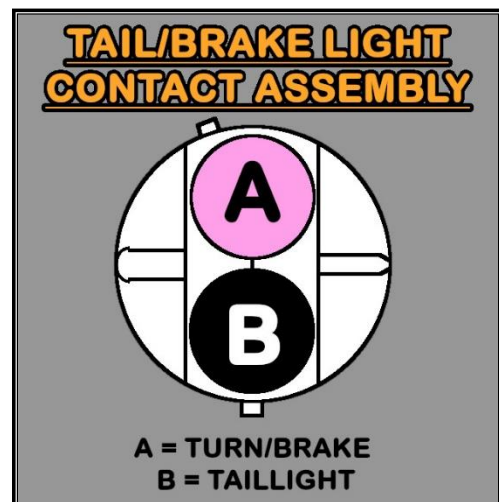
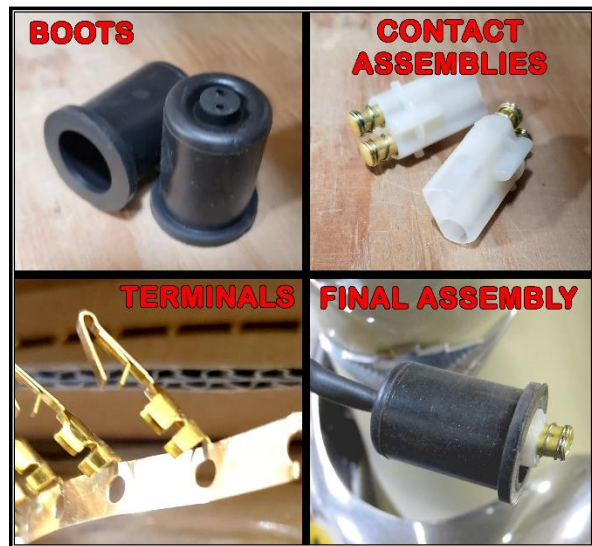

## REVERSE LIGHT

This kit provides new reverse light socket assemblies. These sockets ground through their mounting and only require the reverse light signal wire/ It is:

**LT. GREEN:** 18-gauge wire, printed [TAIL SECTION]#956 LEFT REVERSE LIGHT POWER; this wire provides power to the reverse or backup lights. This wire receives power from the reverse switch and has power anytime the shifter is in the "REVERSE" position with the ignition switch in the "ON/RUN" position.



- Install the new sockets from the parts kit. Then, loosely route the **LT. GREEN #956** reverse light wire to the reverse light. Connect in one of the three ways mentioned below.
  1. Cut the wire to length and connect it to the socket pigtail using a **splice** and **heat shrink** from the parts kit.
  2. Alternately, **bullet-style terminals** are provided in the parts kit. Using these terminals will allow you to remove/replace the socket without having to cut and splice the harness again. You can cover the insulated terminal with heat shrink once connected to clean up the look of this connection since colored insulated terminals can often look out of place.
  3. For a cleaner install, remove the **BLACK** wire completely and install the **LT. GREEN #956** wire directly into the socket using a **button contact** from the parts kit.
- Consult the manufacturer's instructions if you are using aftermarket assemblies.
- If your vehicle does not have reverse lights, stow these wires away as they will not be used. The wires only have power if they are connected to a reverse switch. The wires can also be removed from the harness they are is not being used.



## LICENSE PLATE LIGHT

The plate light is the next connection that needs to be made. This light is tied to the taillights and will illuminate the license plate when the headlight switch is in the park light “ON” or headlight “ON” positions. This kit provides new license plate light socket assemblies. These sockets ground through their mounting. It is:

**BLACK:** 18-gauge wires, printed **[TAIL SECTION] #929 LICENSE PLATE LIGHT**; this is a power wire for the license plate light function. This wire has power anytime the headlight switch is in the park light ON or headlight ON positions. This wire, along with all the other wires and splice it is associated with, can be seen in the [Tail Section Schematic](#) on the next page.

- In most cases, your license plate light will have a socket/bullet terminal connection. If you wish to reuse your sockets, **insulated terminals** have been provided in the parts kit to connect to these types of plate lights. You can cover the insulated terminal with heat shrink once connected to clean up the look of this connection since colored insulated terminals can often look out of place.
- If you replace the socket assemblies with those provided in the Painless kit, connect in one of the three ways mentioned below.
  1. Cut the wire to length and connect it to the socket pigtail using a **splice** and **heat shrink** from the parts kit.
  2. Alternately, **bullet-style terminals** are provided in the parts kit. Using these terminals will allow you to remove/replace the socket without having to cut and splice the harness again. You can cover the insulated terminal with heat shrink once connected to clean up the look of this connection since colored insulated terminals can often look out of place.
  3. For a cleaner install, remove the socket’s **BLACK** wire completely and install the **BLACK #929** wire directly into the socket using a **button contact** and **heat shrink** from the parts kit.

## RIGHT TURN/ BRAKE/ TAILLIGHT & REVERSE LIGHT

The connections mentioned above all connect in the same manner as those on the left/driver side. The only difference you will find is the turn signal wire for the right turn signal is a different color than the one used for the left turn signal. The right turn signal will be:

**PURPLE:** 16-gauge wire, printed **[TAIL SECTION] #948 RIGHT TURN / BRAKE**; this wire provides power to the right turn signal. This wire has power anytime the turn signal is in the up/right position and the ignition switch is in the *ON/RUN* position. For vehicles with integrated turn/brake signals, this wire is also the brake light power and has power anytime the brake pedal is pressed or the hazard switch is activated. This wire can be seen in the [Tail Section Schematic](#) on the next page.

# TAIL SECTION SCHEMATIC

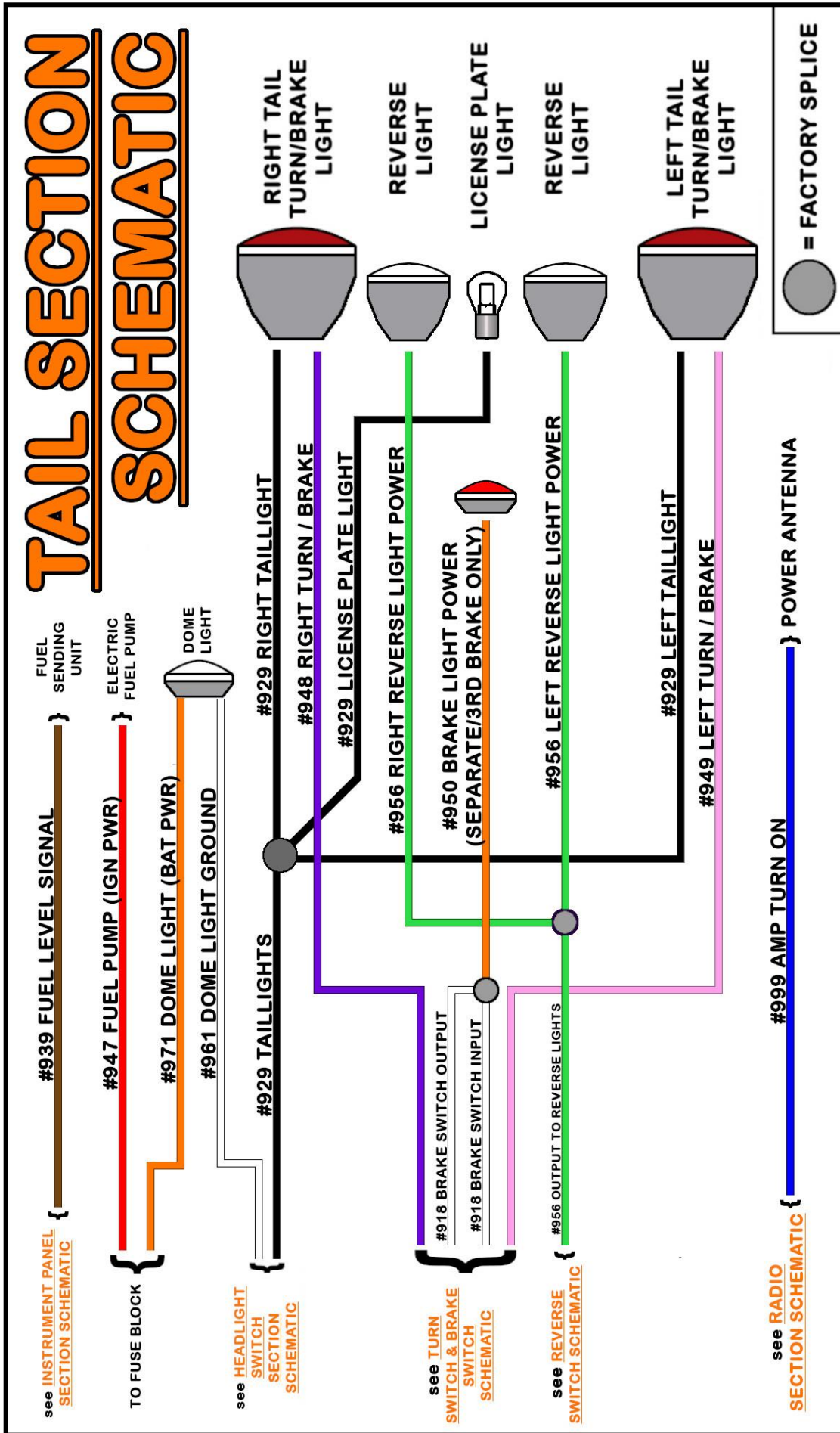

# TESTING THE SYSTEM

Use a small (10 amp or less) battery charger to power up the vehicle for the first time to test the circuits. If there is a problem anywhere, the battery charger's low amperage and internal circuit breaker will provide circuit protection.

- Make sure the negative (-) battery cable is connected to the frame or engine block, and make sure there is a ground between the engine and frame. **The negative battery cable should still be disconnected from the Battery**

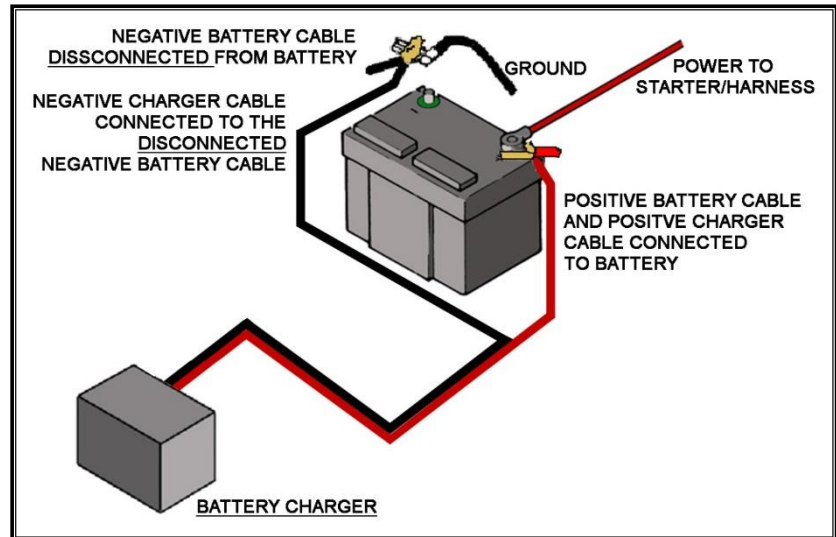

- Connect the positive (+) battery cable to the positive side of the battery and make sure the other end of this cable is connected to the B+ side of the starter solenoid.
- At this point connect the **RED #915** from the MIDI fuse to the positive side of the battery, either through the starter lug or the battery lug.
- Connect the Battery Charger's NEGATIVE cable to the automobile chassis, engine block, or the disconnected Negative Battery cable. **Do NOT connect the Battery Charger's NEGATIVE cable to the Battery.**
- Connect the Battery Charger's POSITIVE cable to the automobile's positive battery terminal lug.
- INDIVIDUALLY turn on each light, ignition, wiper circuit, etc. and check for proper operation. Turn off each component before testing another.

**Note: If you try to test more than one circuit at a time, the charger will not provide enough amperage for each circuit to work correctly.**

- After all circuits have been checked, disconnect the battery charger and attach the vehicle's negative (ground) battery cable to the battery.
- Once testing is complete, re-install any panels, lens, or other parts that were removed during the harness installation. You are now finished installing this Painless Harness, congratulations!

# WIRE INDEX

- The index is listed in the same order in which the manual instructed components to be connected.
- The **BLUE** descriptions indicate sections found throughout the harness.
- **ORIGIN** indicates where the opposite end of this wire is.

## FRONT LIGHT SECTION

Color	Gauge	Wire Print	Origin
Blue	18	#925 RIGHT FRONT TURN SIGNAL	Turn Switch
Light Blue	18	#926 LEFT FRONT TURN SIGNAL	Turn Switch
Tan	14	#909 LEFT LOW BEAM	Dimmer Switch
Tan	14	#909 RIGHT LOW BEAM	Dimmer Switch
Purple	18	#927 RIGHT PARK LIGHT	Headlight Switch
Purple	18	#927 LEFT PARK LIGHT	Headlight Switch
Light Green	14	#908 LEFT HIGH BEAM	Dimmer Switch
Light Green	14	#908 RIGHT HIGH BEAM	Dimmer Switch
Black	14	#924 HORN	Horn Relay
Grey/White	18	#901 RELAY ACTIVATION (IGN POWER)	Fuse Block

## ENGINE SECTION

Color	Gauge	Wire Print	Origin
Pink	16	#920 COIL (IGN PWR)	Fuse Block
Green	18	#921 COOLANT TEMP SIGNAL	Instrument Panel
Lt.Blue/Black	18	#922 OIL PRESSURE SIGNAL	Instrument Panel
Green/White	18	#923 TACHOMETER SIGNAL	Instrument Panel
Red	18	#954 ELECTRIC CHOKE (IGN PWR)	Fuse Block

## MIDI SECTION

Color	Gauge	Wire Print	Origin
Red	8	#916 BATTERY POWER SOURCE (MIDI FUSE)	Fuse Block

## ALTERNATOR SECTION

Color	Gauge	Wire Print	Origin
Brown/White	18	#914 REGULATOR POWER (IGN PWR)	Fuse Block
Red	14	#995 REGULATOR POWER (BAT PWR)	Fuse Block

### DIMMER SWITCH SECTION

Color	Gauge	Wire Print	Origin
Light Green	14	#908 HIGH BEAM	Front light Section
Tan	14	#909 LOW BEAM	Front light Section
Yellow	14	#907 DIMMER SWITCH	Headlight Switch

### HEADLIGHT SWITCH SECTION

Color	Gauge	Wire Print	Origin
Red	12	#928 HEADLIGHT SWITCH POWER (BAT PWR)	Fuse Block
Orange	14	#959 PARK/TAIL POWER IN (BAT PWR)	Fuse Block
Yellow	14	#907 DIMMER SWITCH	Dimmer Switch
Purple	18	#927 FRONT PARK LIGHT POWER	Front Light Section
Green	16	#930 GAUGE / PANEL LIGHTING	Instrument Panel
Black	16	#929 TAILLIGHTS	Tail Section
White	18	#961 DOME/COURTESY LIGHT ACTIVATION	Tail Section
Grey	18	#930 BACKLIGHT POWER	AftMrkt Gauges

### TURN SIGNAL SWITCH SECTION

Color	Gauge	Wire Print	Origin
White	18	#918 BRAKE SWITCH INPUT	Brake Switch
Blue	18		Front Light Section
Light Blue	18		Front Light Section
Purple	16	#948 RIGHT TURN / BRAKE	Tail Section
Pink	16	#949 LEFT TURN / BRAKE	Tail Section
Brown	18	#951 HAZARD SWITCH POWER (BAT PWR)	Fuse Block
Yellow	16	#952 TURN SIGNAL SWITCH POWER (IGN PWR)	Fuse Block
Green	18	#963 HORN RELAY GROUND ACTIVATION	Fuse Block

### BRAKE SWITCH SECTION

Color	Gauge	Wire Print	Origin
White	18	#918 BRAKE SWITCH OUTPUT	Tail Section
Orange	18	#917 BRAKE SWITCH (BAT PWR)	Fuse Block

### DRIVER JAMB SWITCH

Color	Gauge	Wire Print	Origin
White	18	#961 DRIVER SIDE DOOR JAMB SWITCH	Headlight Switch

### DRIVER COURTESY LIGHT SECTION

Color	Gauge	Wire Print	Origin
Orange	18	#971 DRIVER COURTESY LIGHT (BAT PWR)	Fuse Block
White	18	#961 DRIVER COURTESY LIGHT GROUND	Headlight Switch

### IGNITION SWITCH SECTION

Color	Gauge	Wire Print	Origin
Red	12	#934 IGNITION SWITCH POWER (BAT PWR)	Fuse Block
Purple	12	#919 STARTER SOLENOID (START)	Starter/NSS
Brown	12	#933 IGN POWER TO FUSE BLOCK	Fuse Block
Brown	12	#933 IGN POWER TO FUSE BLOCK	Fuse Block
Pink	12	#932 ACCESSORY POWER	Fuse Block
Grey	18	#930 IGN. SWITCH LIGHT POWER	Headlight Switch

### BLOWER SWITCH SECTION

Color	Gauge	Wire Print	Origin
Brown	14	#904 HEATER/AC POWER (IGN PWR)	Fuse Block
Brown	14	#967 BLOWER MOTOR POWER	Blower Motor
Grey	18	#930 HVAC PANEL LIGHT POWER	Headlight Switch

### GROUND SECTION

Color	Gauge	Wire Print	Origin
Black	14	#969 TO CHASSIS GROUND	Various

### PASSENGER COURTESY LIGHT & JAMB SWITCH

Color	Gauge	Wire Print	Origin
Orange	18	#971 PASS. COURTESY LIGHT (BAT PWR)	Fuse Block
White	18	#961 PASSENGER SIDE DOOR JAMB SWITCH	Headlight Switch
White	18	#961 PASS. COURTESY LIGHT GROUND	Headlight Switch

### INSTRUMENT PANEL SECTION

Color	Gauge	Wire Print	Origin
<b>Brown/White</b>	18	#914 ALT/GEN LIGHT POWER (IGN PWR)	Fuse Block
<b>Lt. Green</b>	18	#936 HIGH BEAM INDICATOR	Dimmer Switch
<b>Lt. Blue</b>	18	#937 LEFT TURN INDICATOR	Turn Sig. Sw.
<b>Pink</b>	18	#935 GAUGE POWER (IGN PWR)	Fuse Block
<b>Green</b>	18	#921 COOLANT TEMP SIGNAL	Engine Section
<b>Lt. Blue/Black</b>	18	#922 OIL PRESSURE SIGNAL	Engine Section
<b>Green/White</b>	18	#923 TACHOMETER SIGNAL	Engine Section
<b>Grey</b>	18		Headlight Switch
<b>Brown</b>	18	#939 FUEL LEVEL SIGNAL	Tail Section
<b>Blue</b>	18	#938 RIGHT TURN INDICATOR	Turn Sig. Sw.
<b>Black</b>	18	#969 GROUND	Ground Splice
<b>Red</b>	18		Gauge Controller
<b>Brown/White</b>	18	#914 REGULATOR POWER (IGN PWR)	Alternator

### AFTERMARKET GAUGES SECTION

Color	Gauge	Wire Print	Origin
<b>Black</b>	18		Ground Splice
<b>Green</b>	18	#921 COOLANT TEMP SIGNAL	Engine Section
<b>Lt. Blue/Black</b>	18	#922 OIL PRESSURE SIGNAL	Engine Section
<b>Pink</b>	18	#935 GAUGE POWER (IGN PWR)	Fuse Block
<b>Green/White</b>	18	#923 TACHOMETER SIGNAL	Engine Section
<b>Grey</b>	18	#930 BACKLIGHT POWER (IGN PWR)	Headlight Switch

### REVERSE SWITCH SECTION

Color	Gauge	Wire Print	Origin
<b>Pink</b>	18	#958 REVERSE SWITCH POWER (IGN PWR)	Fuse Block
<b>Light Green</b>	18	#956 OUTPUT TO REVERSE LIGHTS	Tail Section

### NEUTRAL SAFETY SWITCH SECTION

Color	Gauge	Wire Print	Origin
<b>Purple</b>	12	#919 STARTER SOLENOID (START)	Ignition Switch

### RADIO SECTION

Color	Gauge	Wire Print	Origin
<b>Yellow</b>	18	#940 RADIO BATTERY POWER	Fuse Block
<b>Red</b>	18	#941 RADIO IGN POWER	Fuse Block
<b>Blue</b>	18	#999 AMP TURN ON	Tail Section
<b>Black</b>	18	#969 RADIO GROUND	Ground Splice
<b>Grey</b>	18	#930 RADIO BACK LIGHTING	Headlight Switch

## ACCESSORY SECTION B+

Color	Gauge	Wire Print	Origin
Pink	16	#906 ACCESSORY POWER (IGN PWR)	Fuse Block
Grey	18	#930 GAUGE/GEAR IND. LIGHT	Headlight Switch
Pink	12	#911 WINDOW POWER (IGN PWR)	Fuse Block
Yellow	16	#905 WIPER SWITCH POWER (IGN PWR)	Fuse Block
Orange	12	#910 DOOR LOCK POWER (BAT PWR)	Fuse Block
Grey	18	#930 CLOCK BACKLIGHTING	Headlight Switch
Black	16	#969 ACCESSORY GROUND	Ground Splice
Brown	14	#967 BLOWER MOTOR POWER	Blower Switch
Red	16	#903 CIG. LIGHTER/POWER PORT (BAT PWR)	Fuse Block
Red	18	#965 CLOCK POWER (BAT PWR)	Fuse Block
Orange	18	#990 GLOVE COMP. LIGHT POWER (BAT PWR)	Fuse Block

## TAIL SECTION

Color	Gauge	Wire Print	Origin
Purple	16	#948 RIGHT TURN / BRAKE	Turn Switch
Orange	16	#971 DOME LIGHT (BAT PWR)	Fuse Block
Blue	16	#999 AMP TURN ON	Radio
Pink	16	#949 LEFT TURN / BRAKE	Turn Switch
Black	18	#929 LICENSE PLATE LIGHT	Headlight Switch
Brown	18	#939 FUEL LEVEL SIGNAL	Instrument Panel
Orange	16	#950 BRAKE LIGHT POWER (SEPARATE/3RD BRAKE ONLY)	Brake Switch
Black	18	#929 LEFT TAILLIGHT	Headlight Switch
Black	18	#929 RIGHT TAILLIGHT	Headlight Switch
Red	18	#947 FUEL PUMP (IGN PWR)	Fuse Block
White	18	#961 DOME LIGHT GROUND	Headlight Switch
Lt. Green	18	#956 RIGHT REVERSE LIGHT POWER	Reverse Switch
Lt. Green	18	#956 LEFT REVERSE LIGHT POWER	Reverse Switch





## **Painless Performance Products, LLC**

### **Limited Warranty and Return Policy**

Chassis harnesses, fuel injection harnesses, and Trail Rocker units are covered under a lifetime warranty.

All other products manufactured and/or sold by Painless Performance are warranted to the original purchaser to be free from defects in material and workmanship under normal use. Painless Performance will repair or replace defective products without charge during the first 12 months from the purchase date. No products will be considered for warranty without a copy of the purchase receipt showing the seller's name, address, and date of purchase. You must return the product to the dealer you purchased it from to initiate warranty procedures.



**Painless Performance Products LLC**  
**2501 Ludelle Street**  
**Fort Worth, TX 76105**  
**Phone (817) 244-6212**