



# Installation Instructions

## HighRock 4x4™ Front Bumper

Vehicle Application: 2007 Jeep® Wrangler and Wrangler Unlimited

•HighRock 4x4™ Front Bumper

Part Number: 42918 / 44918

•HighRock 4x4™ Approach Roller™











Part Number: 42905 (Sold Separately)

•HighRock 4x4™ Tubular Grill Guard

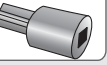
Part Number: 42915 /

44915 (Sold Separately)

[www.Bestop.com](http://www.Bestop.com) - We're here to help! Visit our web site and click on "[Ask a Question](#)". Click here for more [Jeep® Accessories by Bestop](#).

INSTALLATION TIME	SKILL LEVEL
 <b>1-1/2 Hours</b>	 <b>3 - Moderately Difficult</b>
TOOLS	
<b>Socket</b>  15mm, 18mm, 3/8" and 1/2"	<b>Ratchet</b> 
<b>Torx Socket</b>  T55	<b>Wrench</b>  18mm and 3/8"
<b>Allen Wrench</b>  3/16" and 6mm	<b>Phillips Screwdriver</b> 
<b>Flat-Head Screwdriver</b> 	<b>Pliers</b> 
<b>Safety Glasses</b> 	



**! WARNING** Do not use Front Bumper to tow vehicle.

**! WARNING** This product is designed primarily to enhance the appearance of the vehicle. Do not rely in any way on the components of this product to protect against injury or death in the event of an accident. Never operate the vehicle in excess of manufacturer's specifications.

### WEAR SEAT BELTS AT ALL TIMES

Read and follow, precisely, all installation instructions provided when installing product. Failure to do so may result in a poor fit and could place occupants of the vehicle in a potentially dangerous situation.

# HighRock 4x4™ Front Bumper Installation Instructions

## Parts List and Hardware Identification

### 42918 HighRock 4x4™ Front Bumper

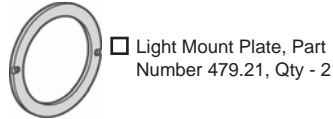
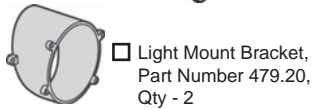
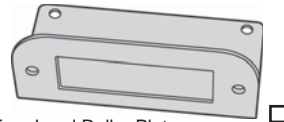
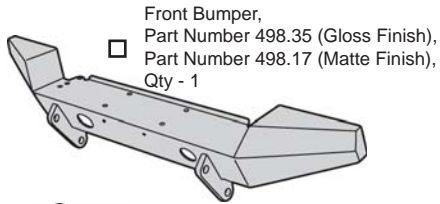

### Hardware Kit Part # 485.73

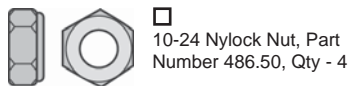
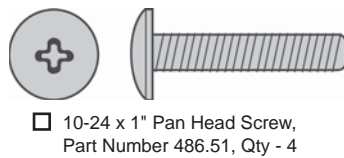
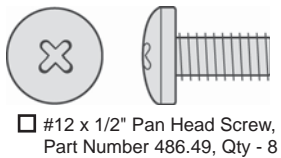

### 42915 HighRock 4x4™ Tubular Grill Guard – Sold Separately

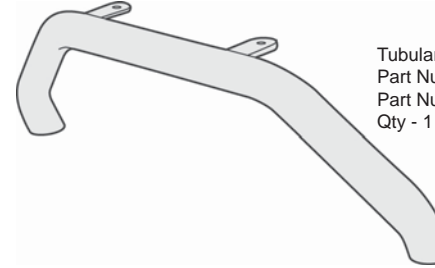

### Hardware Kit Part # 498.36



### 42905 HighRock 4x4™ Approach Roller™ – Sold Separately

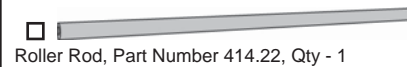
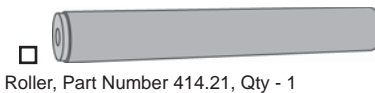

### Hardware Kit Part # 498.37

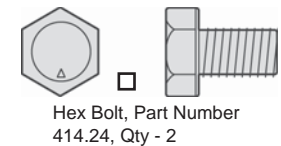

# HighRock 4x4™ Front Bumper Installation Instructions

**NOTE** If you intend to install a fare lead roller and/or a winch on your bumper, you will need to install them on the bumper before you install the bumper on the vehicle.

If you decide at a later date to install a fare lead roller or winch on your vehicle, it will be easiest to remove the bumper from the vehicle before installing.

If you wish to install a winch without a fare lead roller, skip step 3.

If you do not wish to install a fare lead roller or winch at this time, skip steps 3 and 4.

## 1 Remove the Plastic Skid Plate

Use a flat screwdriver or pliers to pry out the four (4) fasteners that secure the edge of the skid plate. Then use a phillips screwdriver to remove the push fasteners that secure the brackets on the skid plate to the frame.

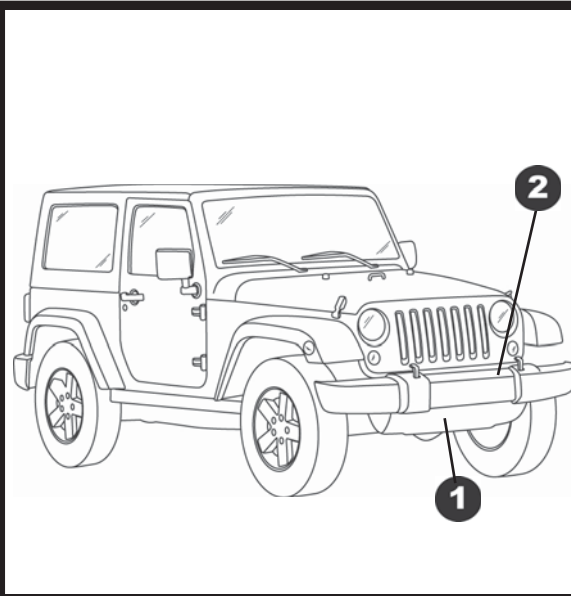
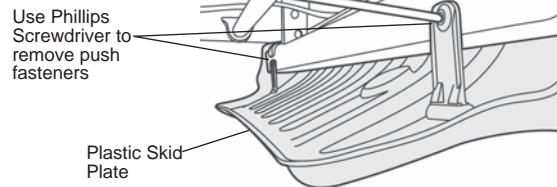
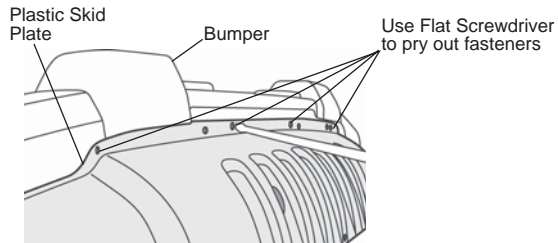

## 3 Install Fare Lead Roller on Fare Lead Plate

If you have a Fare Lead Roller, use the mounting hardware provided with the roller to install it on the Fare Lead Plate.

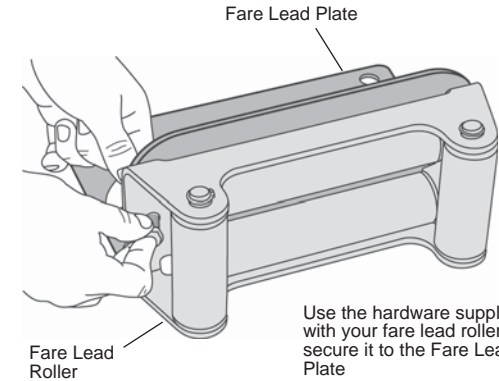

**CAUTION** If you have a Jeep® Rubicon with Factory Fog Lights, you must disconnect them before removing the bumper.

## 2 Remove the Original Bumper

Use a socket wrench to remove the four (4) nuts on each side of the bumper that secure the bumper to the frame. Access these nuts from behind the bumper. Slide the bumper off the studs.

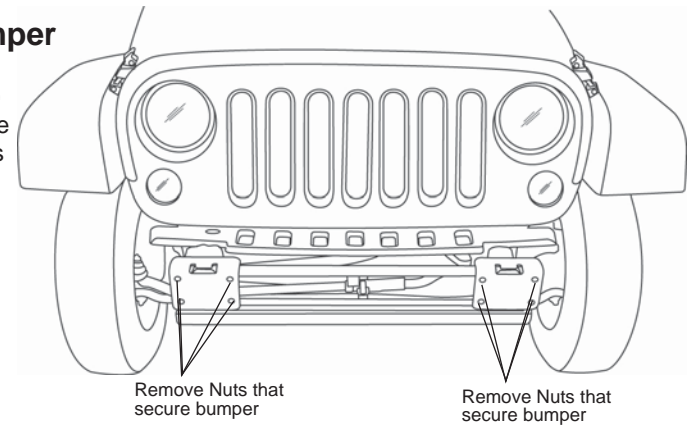

# HighRock 4x4™ Front Bumper Installation Instructions

## 4 Install Light Mount Brackets on Lights

Remove the lights from the original bumper. Set the screws aside to be re-used.

Orient the light with the adjustment screw facing down. Use four (4) #12 x 1/2" Pan Head Screws to secure the light to the Light Mount Bracket. Repeat with both lights.

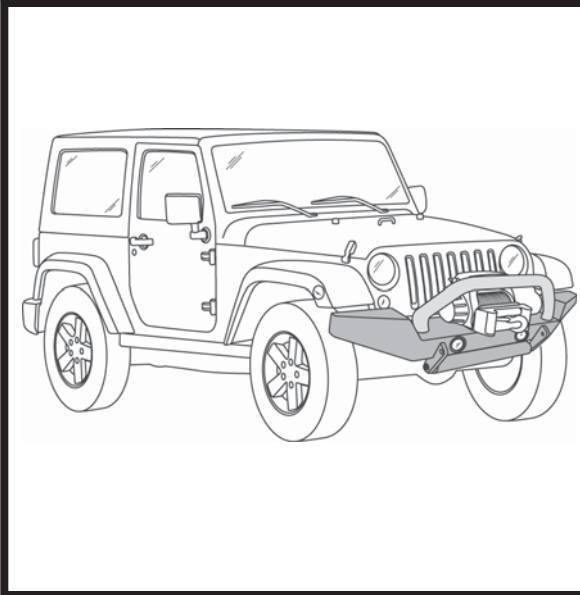
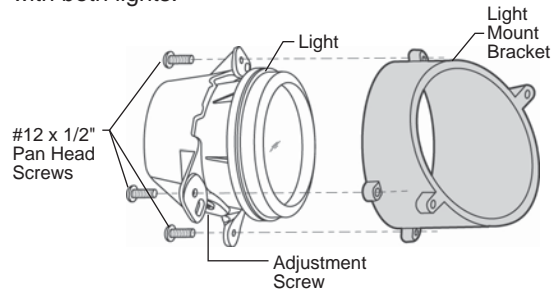

**NOTE** If you intend to install a winch only, you may install it directly on your bumper and do not need to use the Fare Lead Plate.

## 6 Install Fare Lead Plate and/or Winch on Bumper

Place the Front Bumper on a flat surface. Place the Fare Lead Plate assembly on the bumper and align the mounting holes. Place the winch on top of the plate and use the hardware provided with the winch to secure it to the bumper.

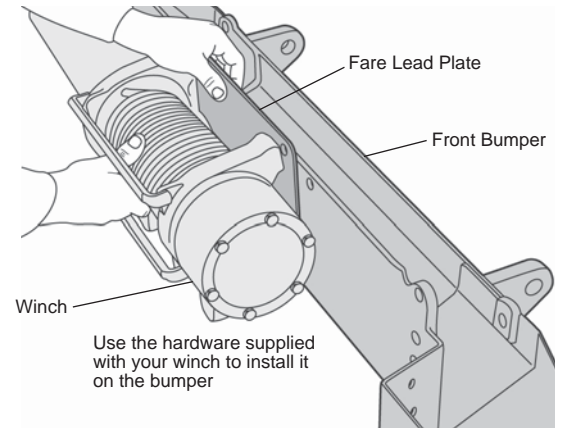

## 5 Install Lights on Bumper

Use the 10-24 Pan Head Screws and 10-24 Nylock Nuts to secure the Light Assemblies to the Bumper. Mount the assemblies from behind the Bumper to the Light Mount Plates on the front.

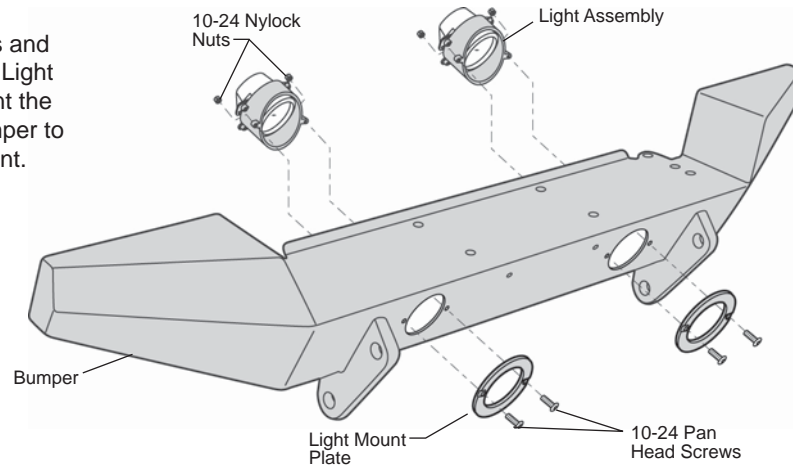

# HighRock 4x4™ Front Bumper Installation Instructions

## 7 Install 42915 HighRock 4x4™ Tubular Grill Guard – Sold Separately

Place the Tubular Grill Guard on the Front Bumper so that the holes in the guard line up with the holes in the bumper. Use two (2) Hex Bolts, Washers, Lock Washers and Lock Nuts to secure each side of the Tubular Grill Guard.

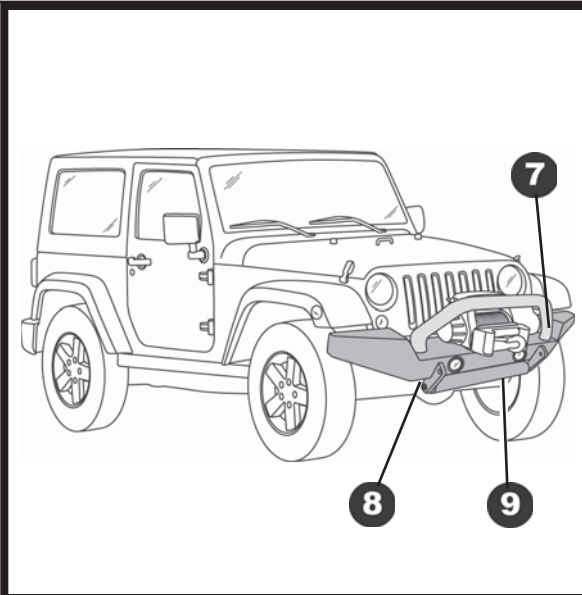
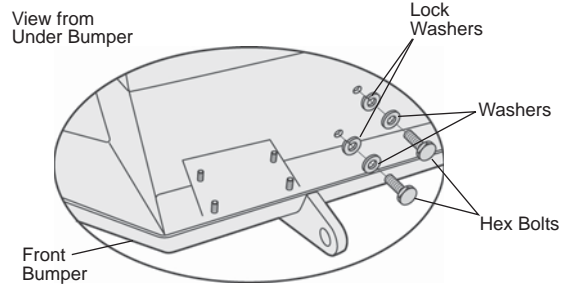
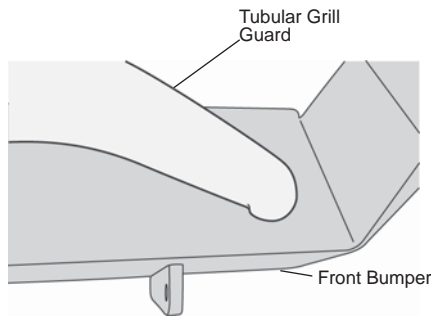

## 9 Install 42905 HighRock 4x4™ Approach Roller™ – Sold Separately

Place the Roller between the flanges on the Front Bumper and align the holes in the Roller with the holes in the flange. Slide the Rod through the flanges and the Roller. Install a Hex Bolt and a Washer in each end of the Rod to secure it to the flanges.

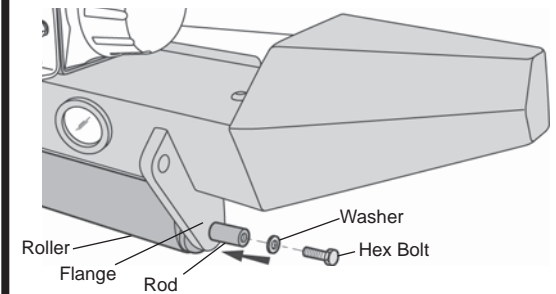

**CAUTION** Two or more people are required to lift the bumper safely.

## 8 Install Bumper Assembly

Lift the Front Bumper Assembly onto the front frame rails on the vehicle. Slide the studs in the Bumper through the holes in the frame and install an M10 Washer and M10 Nylock Nut on each stud.

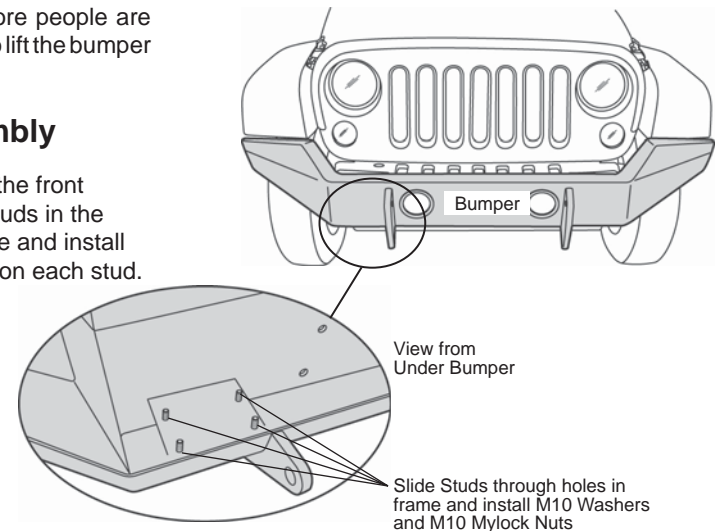

# HighRock 4x4™ Front Bumper Installation Instructions

---

## Limited Warranty

We warrant our product to be free from defects in material and workmanship, for the terms specified below, provided there has been normal use and proper maintenance. This warranty applies to the original purchaser only. All remedies under this warranty are limited to the repair or replacement of any item or items found by the factory to be defective within the time period specified.

If you have a warranty claim, first you must call our factory at the number below for instructions. You must retain proof of purchase and submit a copy with any items returned for warranty work. Upon completion of warranty work, if any, we will return the repaired or replaced item or items to you freight prepaid. Damage to our products caused by accidents, fire, vandalism, negligence, misinstallation, misuse, Acts of God, or by defective parts not manufactured by us, is not covered under this warranty.

THE WARRANTY TIME PERIOD IS AS FOLLOWS: ALL "PRODUCTS" MANUFACTURED BY OUR COMPANY: ONE YEAR FROM DATE OF PURCHASE.

ANY IMPLIED WARRANTIES OF MERCHANTABILITY AND/OR FITNESS FOR A PARTICULAR PURPOSE CREATED HEREBY ARE LIMITED IN DURATION TO THE SAME DURATION AND SCOPE AS THE EXPRESS WRITTEN WARRANTY. OUR COMPANY SHALL NOT BE LIABLE FOR ANY INCIDENTAL OR CONSEQUENTIAL DAMAGE.

Some states do not allow limitations on how long an implied warranty lasts, or the exclusion or limitation of incidental or consequential damages, so the above limitations or exclusions may not apply to you.

This warranty gives you specific legal rights, and you may also have other rights which vary from state to state.



For further information or request for warranty work, please contact:  
Bestop Inc. Customer Service  
(800) 845-3567  
(303) 465-1755