



**Installation Instructions**  
**Rear Bumper W/Tire Carrier**  
**87 - 06 Wrangler**

LEADING MANUFACTURER OF TUBULAR PRODUCTS

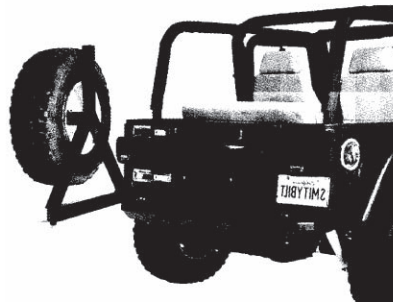
**NOTE:** Please read this information before installing. **DRILLING REQUIRED** for the installation of this bumper. To obtain correct installation, we recommend you follow these step-by-step instructions carefully. Please take care when installing this product to protect the finish and your investment.

**INCLUDED COMPONENTS**

	<b>BOX 1 OF 2 (76651-01)</b>		<b>BOX 2 OF 2 (76651-02)</b>	
<b><u>QTY</u></b>	<b><u>DESCRIPTION</u></b>		<b><u>QTY</u></b>	
			<b><u>DESCRIPTION</u></b>	
1	Rear Bumper w/ Splindle		1	Tire Carrier w/Latch Mechanism Installed
4	Backing Plates		1	Post Bar
2	TJ Reinforcement Brackets (L&R)		1	Nylon Washer
2	YJ Reinforcement Brackets (L&R)		1	Tire Mount
2	M12 x 35mm hex Head Bolts		1	Circle Clip
8	3/8"-16 x 1-1/4" Hex Head Bolts		3	3/8"-24x1" Hex Head Bolts
8	3/8" Flat Washers		2	3/8"-24x1-1/4" Hex Head Bolts
8	3/8" Lock Washers		12	3/8" Flat Washers
6	1/2"-20 x 1-1/4" Head Head Bolts		5	3/8"-24 Nylock Nuts
8	1/2" Flat Washers		1	3/8"-16x2.5" Hex Head Bolt
4	1/2" Lock Washers		1	3/8"-16 Nylock Nut
2	1/2" Fender Washers		1	Rubber Bushing / Spacer
2	1/2" Nylock Nut w/ Fender Washer		1	#10 x 1" Phillips Pan Head Sheet Metal Screw
2	7/16-14 x 1-1/4" Hex Head bolts			
2	7/16" Flat Washers			
2	7/16" Lock Washers			

**IMPORTANT INFORMATION**

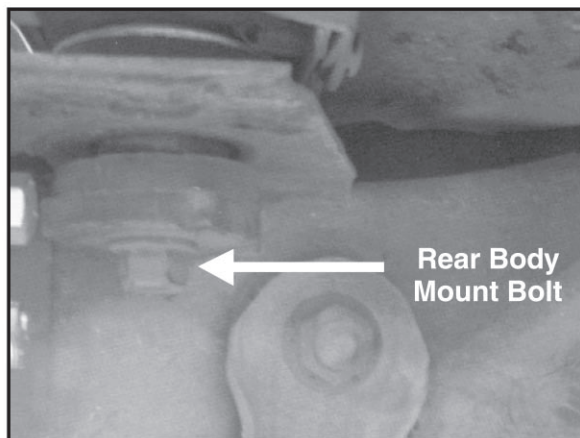
- Holes may need to be drilled through the side of the frame
- Will accomodate up to a 35" Spare tire
- Factory bumper and tire carrier will need to be removed to install the carrier
- The 3rd brake light will need to be relocated. Location may vary due to tire size
- This bumper is NOT RATED FOR TOWING



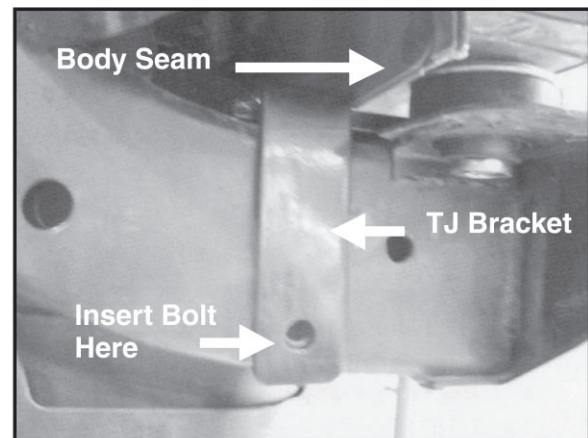
## **SUPPORT BRACKET INSTALLATION INSTRUCTIONS**

1. Remove factory bumper and rear body mount on both sides (Figure 1).
2. The use of a pry bar and some assistance will be needed to install the Reinforcement Brackets. Place pry bar between the body and frame, lift body and remove body mount. **"CAUTION": Be extremely careful not to damage the paint or body when lifting.**
3. Use vise grips to bend body seam above the frame rail forward toward front of Jeep (Figure 2). This will allow clearance for Reinforcement Bracket. **NOTE:** If Jeep has a body lift this step is not required.
4. Lift body with pry bar and slide Reinforcement Bracket between body and frame rail.
5. **TJ Wrangler:** Locate (1) 1/2"-20 x 1 1/4" Hex Head Bolt, (2) 1/2" Flat Washers, and (1) 1/2" Fender Flange Lock Nut. Insert Bolt with Flat Washer through hole in the bottom of frame. Go through hole in the side of frame and through Reinforcement Bracket. Secure Bolt with the rest of the hardware listed in this step (Figure 2). Do not tighten at this time. Repeat steps 2-5 for opposite side.  
**YJ Wrangler:** Locate (1) 1/2"-20 x 1 1/4" Hex Head Bolt, (2) 1/2" Fender Flat Washers, and (1) 1/2" Fender Flange Lock Nut. Insert Bolt with Flat Washer through hole in the top of frame. Go through hole in the top of frame and through Reinforcement Bracket. Insert Fender Flange Nut through the hole on the bottom of the frame and hand tighten at this time (Figure 3). **NOTE:** Taping the Flange Nut to a wrench before inserting into the frame will ease the installation. Repeat steps 2-5 for opposite side.

### **TJ Reinforcement Bracket**

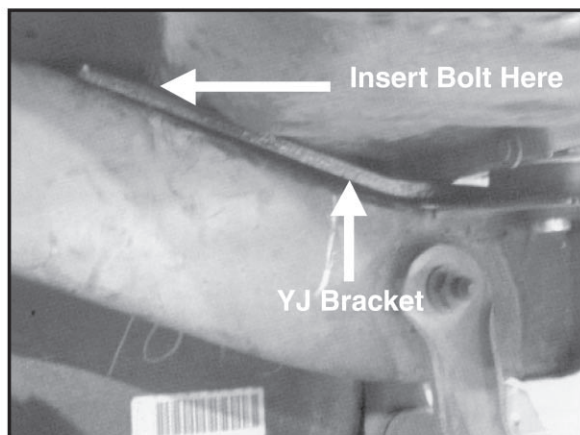


**Figure 1**



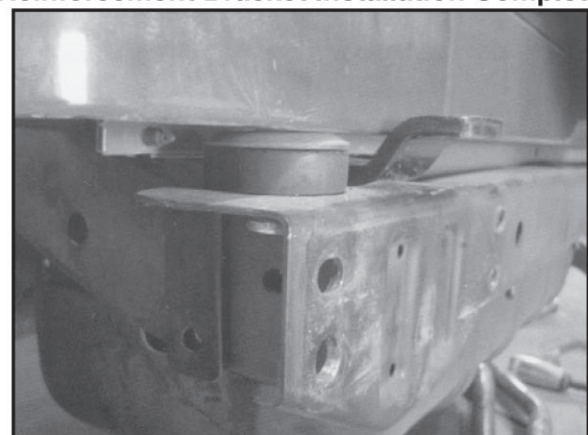
**Figure 2**

### **YJ Reinforcement Bracket**



**Figure 3**

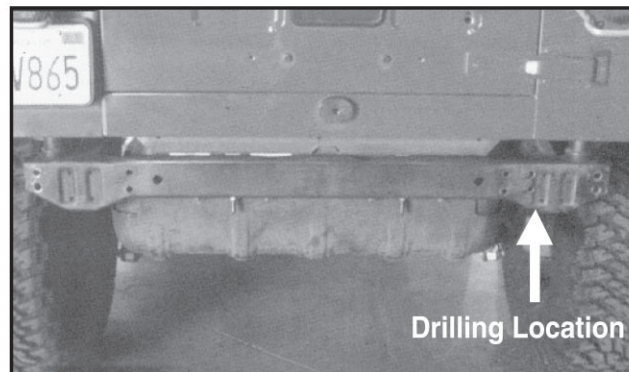
### **Reinforcement Bracket Installation Complete**



**Figure 4**



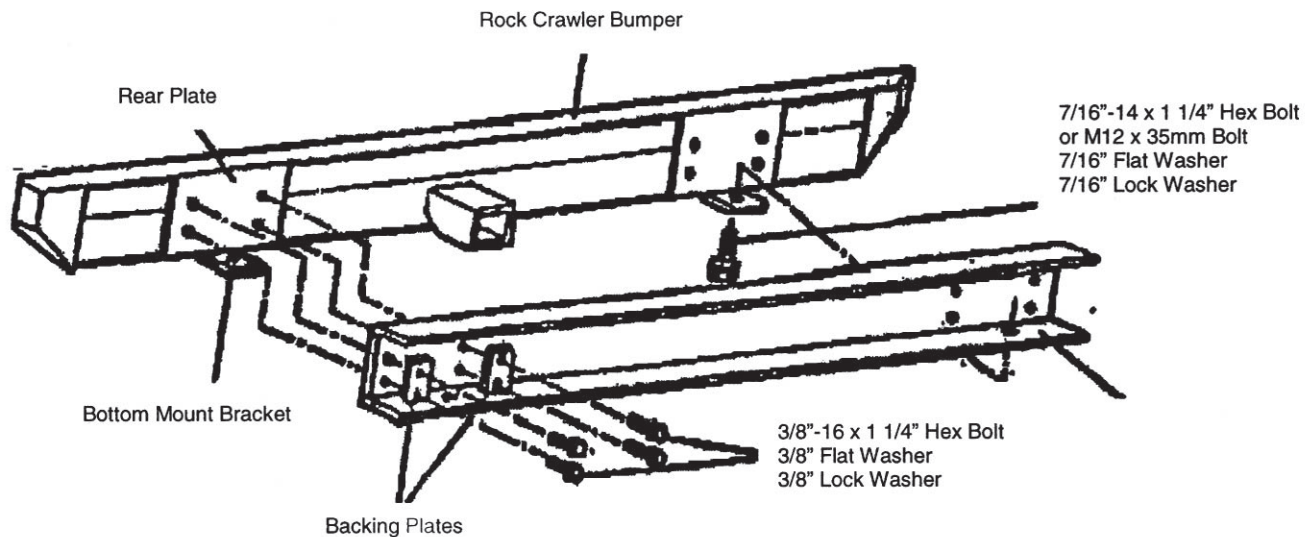
6. Position Bumper in place and start bottom bolts using (2) 7/16"-14 x 1 1/4" Hex Head Bolts or (2) M12 x 35mm Hex Head Bolts (depends on the year model), (2) 7/16" Flat Washers, and (2) 7/16" Lock Washers. Do not tighten at this time.
7. 97 TJ's have holes on the inside of the frame rail. These holes are not on 98-on TJ's and are not required. These are optional and will require dropping the fuel tank to reach the installation of the inner Metal Plates. However if you would like to install the inner Metal Plates, they must be drilled to 7/16".NOTE: Measure the distance on the mounting bracket and match these measurements on the frame or you may mount the outer four holes to the frame and use the holes on the bracket as a template to mark the drilling locations (Figure 5). Remove Bumper and set aside. Drill the frame holes to 7/16". **CAUTION: Use extreme care in assuring the locations you drill are correct. Before drilling be sure to check the backside of the frame for possible hazards or obstructions.**



**Figure 5**

8. Position the new bumper against the back of the vehicle frame and reinstall Hardware listed in Step 6. Locate (8) 3/8"-16 x 1 1/4" Hex Head Bolts, (8) 3/8" Flat Washers, (8) 3/8" Lock Washers, and (4) Backing Plates. Secure Bumper to frame by using the hardware listed in this step (Figure 6). Do not tighten hardware at this time.
9. Locate (4) 1/2"-20 x 1 1/4" Hex Head Bolts, (4) 1/2" Lock Washers, and (4) 1/2" Flat Washers. Carefully start all four bolts through the top of the Reinforcement Bracket into top of Bumper. Tighten all hardware at this time.

*Illustration is for reference only, styles may vary with application*



**Figure 6**

## **TIRE CARRIER INSTALLATION INSTRUCTIONS**

9225 Stellar Ct. Unit C, Corona, CA 92883 (951)277-4949

Page 3 of 5

Made in China

Rev. 12/09

10. Insert Nylon Washer and install the Tire Carrier to Bumper. Once the Tire Carrier is assembled, close it and secure it with the already installed (2) 3/8"-24 x 1" Hex Head Bolt, (4) 3/8" Flat Washers, and (2) 3/8" Lock Nuts (Figure 7 & 8). Tighten hardware at this time.
11. Install the Circle Clip to the top of the Post on the Bumper. Once installed, use a grease gun to lubricate the pivot.

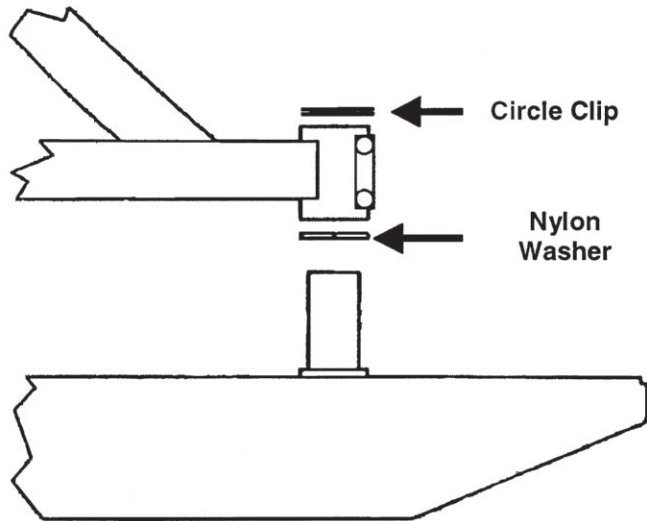


Figure 7

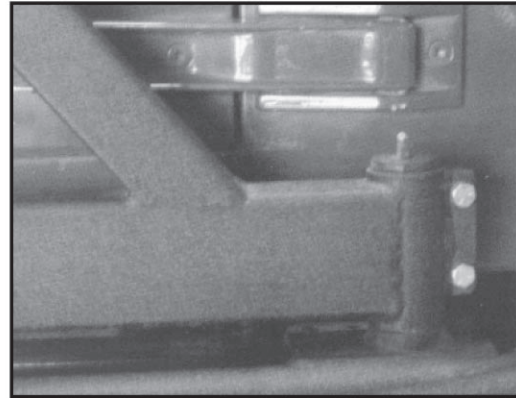


Figure 8

12. Locate Post, (1) 3/8"-16 x 2.5" Hex Head Bolt, (2) 3/8" Flat Washers, and (1) 3/8" Nylock Nut. Insert Post into Tire Carrier and secure it with hardware listed in this step (Figure 9). Tighten hardware at this time.

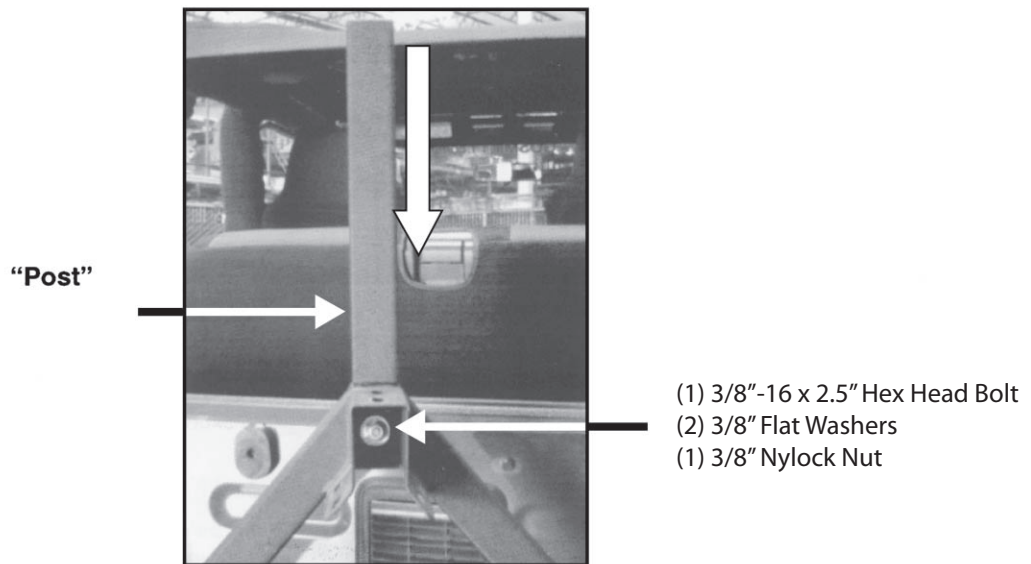


Figure 9



13. Locate Mounting Bracket, (3) 3/8"-24 x 1" Hex Head Bolts, (6) 3/8" Flat Washers, (3) 3/8" Lock Nuts. Slide Tire Support Bracket into Tire Carrier until holes line up and secure it with hardware listed in this step (Figure 10 & 11). **NOTE:** There are two sets of holes on the Tire Carrier; these are used for oversized tires.
14. It may be necessary to install the rubber bushing / spacer using the #10 x 1" Phillips Pan Head Sheet Metal Screw anywhere on the tire carrier frame as needed to prevent rattling and/or metal-to-metal contact. The location of the bushing / spacer may vary with vehicle and area requiring it..

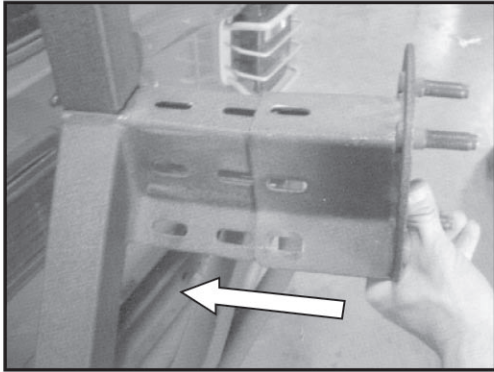


Figure 10

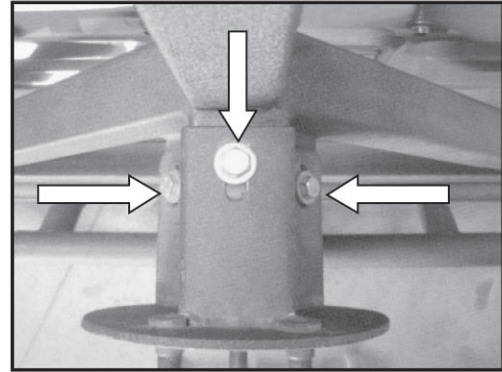


Figure 11

### Limited 12 Month Warranty

Applies to Rook Crawler Products by Rampage

Rampage (the company) warrants to the original purchaser of this product that should the product or any part thereof, under normal use and conditions, be proven defective in material or workmanship within 12 Months from the date of original purchase, such defect(s) will be repaired or replaced (at the Company's option) without charge for parts or repair labor. Please note that installation labor to remove or install this product is not covered under this limited warranty.

To obtain repair or replacement within the terms of this Warranty, the product is to be delivered with proof of warranty coverage (e.g. dated bill of sale), specification of defect(s), freight pre-paid to the place of purchase or, you must contact Rampage Products at the number below for warranty service or to obtain a Return Goods Authorization Number. Items returned to Rampage Products without an Authorized Returns Good Authorization number will be refused and returned back to sender at the sender's expense.

This warranty does not apply to any product or part thereof which, in the opinion of the Company, has suffered or been damaged through alteration, improper installation, mishandling, misuse, neglect, accident or by acts of nature. THE EXTENT OF THE COMPANY'S LIABILITY UNDER THIS WARRANTY IS LIMITED TO THE REPAIR OR REPLACEMENT PROVIDED ABOVE AND, IN NO EVENT, SHALL THE COMPANY'S LIABILITY EXCEED THE PURCHASE PRICE PAID BY PURCHASER FOR THE PRODUCT.

This warranty is in lieu of all express warranties or liabilities. ANY IMPLIED WARRANTIES, INCLUDING ANY IMPLIED WARRANTY OF MERCHANTABILITY, SHALL BE LIMITED TO THE DURATION OF THIS WRITTEN WARRANTY. ANY ACTION FOR BREACH OF ANY WARRANTY HEREUNDER INCLUDING ANY IMPLIED WARRANTY OF MERCHANTABILITY MUST BE BROUGHT WITHIN A PERIOD OF 90 DAYS FROM DATE OF ORIGINAL PURCHASE. IN NO CASE SHALL THE COMPANY BE LIABLE FOR ANY CONSEQUENTIAL OR INCIDENTAL DAMAGES FOR BREACH OF THIS OR ANY OTHER WARRANTY, EXPRESS OR IMPLIED, WHATSOEVER. No person or representative is authorized to assume for the Company any liability other than expressed herein in connection with the sale of this product.

Some states do not allow limitations on how long an implied warranty lasts or the exclusion or limitation of incidental or consequential damage, therefore above limitations may not apply to you. This Warranty gives the purchaser specific legal rights. The purchaser may have additional rights, which vary from state to state.

For Technical Support/Warranty Information, please call: 951-277-4949